



GENSYS 2.0 FAMILY

Technical documentation



*“All-in-one generating set control
and
paralleling unit”*

Part Number:
A53 Z0 9 0020

CRE Technology believes that all information provided herein is correct and reliable and reserves the right to update at any time. CRE Technology does not assume any responsibility for its use. E & O E.

CRE TECHNOLOGY



130, Allée Victor Naudin
Zone des Templier
Sophia-Antipolis
06410 Biot
FRANCE



Phone: +33 (0)4 92 38 86 82

Fax: +33 (0)4 92 38 86 83

Website: www.cretechnology.com



Email: info@cretechnology.com

NOTE



Read this entire manual and all other publications pertaining to the work to be performed before installing, operating, or servicing this equipment. Apply all plant and safety instructions and precautions. Failure to follow instructions can cause personal injury and/or property damage.

Motors, turbines and any other type of generator must be equipped with protections (overspeed, high temperature, low pressure...) depending on the power plant.

Any changes of the normal use of the equipment can cause human and material damage.

For further information, please contact your CRE Technology distributor or the After-Sales Service Team.

All CRE Technology products are delivered with one year warranty, and if necessary we will be happy to come on site for product commissioning or troubleshooting. The company also provide specific trainings on our products and softwares.



Technical support: +33 (0)4 92 38 86 86 (office hours: 8.30AM-12AM / 2PM-6PM GMT+1).

Email: support@cretechnology.com



SKYPE: support-cretechnology.com







INFORMATION

You can download the most up-to-date version of this documentation and different other documentations relating to CRE technology products on our Web site <http://www.cretechnology.com>.

Technical documentation history

Date	Version	Comments
Nov. 2008	A	Derived from GENSYS documentation. Starting point.
Jan. 2008	B	Correction and full explanation of several features.
Feb. 2008	C	Added menu references. Global revision by all the team.
Mar. 2009	D	Details added for the reset of alarms, faults, and data logging. Details added for the semi auto mode.
July 2009	E	J1939 details added. Modification of general wiring diagram. Removal of USB connection. Addition of Ethernet connection.
Sept. 2009	F	Firmware update using SD card added. Chapter on GENSYS 1.0/GENSYS 2.0 compatibility added. Extra information concerning analogue sensors. Information concerning CEM compliance added. Ethernet connection added and USB connection chapter updated. Digital input parameter errors corrected.
Feb. 2010	G	Two phase/three phase system management added. SD card archiving added. Breaker management info added. SD card flashing removed. Start sequence.
July 2010	H	GENSYS 2.0 firmware v2.05 IP address can now be changed. Support of Modbus TCP. J1939 compatibility with Cummins QSX15G8 Automatic shutdown of the horn. Corrections on PWM 500Hz documentation. CANopen example changed.
April 2011	I	Enhanced semi-automatic mode description. New chapter concerning optional power tank capacitor. New: minimum wiring diagram. Updated static paralleling diagram. Updated maintenance cycles chapter. Updated reference of digital input variables. Updated custom logo size. Updated CAN bus good practices. Updated technical support contact. Updated external automatic start module setup description.  Additional features starting from firmware v3.00: CRE Config software compatibility. Assisted manual mode. Front panel button inhibition. Firmware upgrade using SD card. Generating an empty file template. Import/Export/Delete TXT files on SD card. Resetting factory parameters. New methods to permanently store parameters in memory.

Date	Version	Comments
February 2012	J	 <p>Additional features starting from firmware v4.00: Power plant up to 32 modules using CAN bus. Support of FAT32 SDHC cards. Automatic backup of new parameter values. ASSISTED MANUAL mode activated by default. Option 7: Enable/disable internal engine start sequence. Interface with external start module without equation. Fuel/water/oil filling without equation. New menu organization. Potential Alarm/Fault list. Download of a CUSTOM language file.</p> <p>Enhancements and modifications : Update of schematics and graphs. Maximal CT ratio value. Maximum size of text file. Available data space for SD card and internal FIFO loggers. External power tank to be used only with a 12V battery.</p>
August 2012	K	 <p>Compatibility with RDM 2.0 remote display module.</p> <p>GENSYS 2.0 CORE and GENSYS 2.0 LT dedicated chapters. Chapter 10.3, table 22 : AVR Leroy Somer R450 and Stamford MX341. Chapter 13 .8 BSM II cable reference removed (not useful). Chapter 15.3.2: Add J1939 display page of unknown SPN/FMI. Chapter 17.3.12: Add the reset maintenance cycle page. Chapter 15.7.1 : Safely remove your SD card. Chapter 17.4.3.2 : LCD backlight adjustment through "System/Display properties" menu. Chapter 20.2 Accessories : Add A40W2 cable. Chapter 20.1: Add reference of all GENSYS 2.0 family modules.</p>
September 2012	L	 <p>New features supported by v4.03/v4.04:</p> <p>Additional Modbus support including:</p> <ul style="list-style-type: none"> • Multiple TCP connections. • New function support (01, 02, 05, 0F). • Advanced rights management (read/write access). • Support of Modbus RTU over TCP in addition to standard Modbus TCP protocol. <p>Chapter 19.3.10: configurable synchronization dwell timer (E4108).</p> <p>Updated wiring of standard CAN (DB9 connectors) Table 7: Added frequency range of voltage measurements. Chapter 15.3.2: Note on Cummins CPG / G Drive ECU firmwares.</p>

Date	Version	Comments
December 2012	M	<p>New features supported by v4.55:</p>  <p>MARINE product range:</p> <ul style="list-style-type: none"> • Specific front panel and operating modes. • Specific I/O factory settings. • Specific configuration menus. • Advanced power management system and menus. • Uneven load sharing protection on kW and kVAR. • Heavy consumer management accepts 4 independent requests with specific kW level and/or number of engines. • Ability to maintain a predefined kW margin on running engines. Allows immediate management of heavy consumers. <p>Ability to stop a specific engine on request (logic input) if this doesn't overload the power plant.</p> <p>Blinking Alarm/Fault LED if a new event occurs.</p> <p>Logic output function "Voltage synchronization in progress".</p> <p>External engine stop request with load dependent kW checking.</p> <p>User defined labels on transistor and relay outputs C1 to C5, A1 and A2.</p> <p>PWM Caterpillar parameters conform to Caterpillar usage.</p> <p>A maximum of 10 parameters (E1xxx/E4xxx) can be changed per PLC cycle.</p> <p>MARINE:</p> <ul style="list-style-type: none"> • Additional information on non-essential consumers management. • Paralleling a power plant with the shore using a Selco T4000 auto-synchronizer. <p>Additional information on TEST mode usage.</p> <p>Additional information on software options.</p> <p>Additional information on load dependent start/stop sequences.</p> <p>PLC programming language removed: users are advised to use Easy PLC software.</p>
January 2013	M2	<p>Add GENSYS 2.0 MARINE picture on front page</p> <p>Layout of the technical documentation</p>
May 2013	N	<p>Precision on the inductive aspect of parameter E1110 (Power factor setpoint).</p> <p>Add support of speed governor GAC ESD5330.</p> <p>Add support of voltage governor SINCRO.</p> <p>Add chapter 2.1 mechanical characteristics of GENSYS 2.0 CORE.</p> <p>Additional information on Heavy Consumer function.</p> <p>Additional information on Power Reserve function.</p>

You can download the most up-to-date version of this documentation and different other documentations relating to GENSYS 2.0 on our Web site: <http://www.cretechnology.com>.

Documentations available on CRE technology Web site:

- ❖ A53 Z0 9 0020 x-EN is the GENSYS 2.0 technical documentation (this manual). This documentation is generally used for product integration.
- ❖ A53 Z0 9 0031 x-EN is the translation help tool to download a CUSTOM language file.
- ❖ A53 Z0 9 0020 x-EN is the Complete variable list with labels, units and limits in English, in PDF format. This documentation is generally used as reference during the integration phase.
- ❖ A53 Z0 9 0030 x- is the Complete variable list with labels, units and limits in all languages, in EXCEL WORKBOOK format. This documentation is generally used as reference during the installation phase. It is generally called “EXCEL FILE”.

NOTE



Read this entire manual and all other publications pertaining to the work to be performed before installing, operating, or servicing this equipment. Apply all plant and safety instructions and precautions. Failure to follow instructions can cause personal injury and/or property damage.

Contact your CRE Technology distributor for course training.

NOTE FOR GENSYS 2.0 LT



This logo indicates that the function described in the chapter is not available in “LT” modules such as GENSYS 2.0 LT and GENSYS 2.0 LT MARINE.

The main features unavailable in GENSYS 2.0 LT are the support of custom equations and CANopen I/O extensions. If you ever need one of these features, please use a standard GENSYS 2.0 module.



This logo applies to all “MARINE” units. It is used in this documentation to highlight features that are specific to marine units or applications.

Table of content

1	OVERVIEW.....	15
1.1	EUROPEAN UNION DIRECTIVE COMPLIANCE CE	15
1.2	ENVIRONMENT	15
1.3	CHARACTERISTICS.....	16
2	GENSYS 2.0 CORE	17
2.1	CHARACTERISTICS.....	17
2.2	DESCRIPTION.....	17
2.3	USER INTERFACE WITH A RDM 2.0	18
2.4	USER INTERFACE USING DIGITAL INPUTS	18
3	GENSYS 2.0 LT	19
4	GENSYS 2.0 MARINE	20
5	DESCRIPTION	21
5.1	FRONT PANEL	21
5.2	REAR PANEL – CONNECTORS.....	27
6	USER INTERFACE	34
6.1	SECURITY LEVEL AND PASSWORD	35
6.2	LOCAL NAVIGATION	36
6.3	REMOTE CONTROL USING A PC (ETHERNET CONNECTION).....	38
7	OPERATING MODE	44
7.1	ASSISTED MANUAL MODE	44
7.2	AUTOMATIC MODE	47
7.3	TEST MODE	47
7.4	100% MANUAL MODE	48
8	START SEQUENCE	49
9	PREDEFINED CONFIGURATION	51
9.1	SINGLE GENERATOR IN CHANGE-OVER MODE	51
9.2	SINGLE GENERATOR IN NO-CHANGE-OVER MODE	54
9.3	GENERATOR PARALLELING WITH DIGITAL BUS	55
9.4	GENERATORS PARALLELING WITH GENSYS 2.0 AND PARALLEL LINE MODULES	56
9.5	MULTIPLE GENERATORS WITH STATIC PARALLELING	57
9.6	SINGLE GENERATOR PARALLELED WITH MAINS.....	59
9.7	POWER PLANT PARALLELED WITH MAINS USING MASTER 2.0 OR GCR.....	64
9.8	POWER PLANT PARALLELED WITH SEVERAL MAINS USING A MASTER 2.0 OR GCR PER MAINS.....	66
10	INSTALLING AND COMMISSIONING A GENSYS 2.0 APPLICATION.....	67
10.1	MINIMUM WIRING DIAGRAM.....	67
10.2	COMPLETE WIRING DIAGRAM	68
10.3	INSTALLATION INSTRUCTIONS.....	69
10.4	BEFORE COMMISSIONING.....	71
10.5	DURING COMMISSIONING	71
11	DEDICATED I/O LINES	75
11.1	SPEED GOVERNOR INTERFACE	75
11.2	SPEED AND VOLTAGE CONTROL WITH CONTACTS/PULSES	80
11.3	ANALOGUE AVR (AUTO VOLTAGE REGULATOR) CONTROL	83
11.4	RELAY OUTPUT	86
11.5	CRANK/FUEL/STARTER 2/ STARTER 3 FUNCTIONS	89
11.6	WATER PREHEAT/ PRE-LUBRICATION/ PRE-GLOW FUNCTIONS.....	90

11.7	AIR FAN.....	91
11.8	FUEL FILLING/ COOLANT FILLING/ OIL FILLING.....	92
11.9	ANALOGUE LOAD SHARING LINE	95
11.10	WATCHDOG OUTPUT	95
12	I/O LINES	96
12.1	DIGITAL INPUT	96
12.2	DIGITAL OUTPUTS.....	100
12.3	ANALOGUE INPUT (VIA CRE CONFIG SOFTWARE)	105
13	PROTECTIONS.....	109
13.1	DISABLE	109
13.2	GENERATOR ELECTRICAL FAULT	109
13.3	MAINS ELECTRICAL FAULT	109
13.4	ALARM.....	109
13.5	FAULT (SOFT SHUT DOWN)	109
13.6	SECURITY (HARD SHUTDOWN).....	109
13.7	DROOP.....	109
13.8	HELP + FAULT (SOFT SHUT DOWN).....	109
13.9	HELP + GEN. ELECTRICAL FAULT	110
13.10	POTENTIAL ALARMS/FAULTS LIST	110
14	ADDITIONAL FUNCTIONS.....	114
14.1	LOAD SHARING USING INTEGRAL (DE-DROOPING).....	114
14.2	OPERATOR CONTROLLED RETURN TO MAINS	116
14.3	MAINS ELECTRICAL FAULT	117
14.4	GENERATOR ELECTRICAL FAULT	119
14.5	GENSYS 2.0 WITH EXTERNAL AUTOMATIC START MODULE	120
14.6	REMOTE START UPON EXTERNAL PULSE	122
14.7	SAFETY INHIBITIONS.....	123
14.8	USE OF BSM II WITH GENSYS 2.0	125
14.9	GENSYS 2.0 WITH TEM COMPACT	128
14.10	G59 NORM (ACCESS LEVEL -1).....	129
14.11	SCADA	129
14.12	HOW TO SET A GPID	130
14.13	LOAD DEPENDANT START/STOP.....	131
14.14	PHASE OFFSET (DYN11 AND OTHER).....	135
14.15	VOLTAGE SYSTEM (120° THREE PHASES, 180° TWO PHASES, SINGLE PHASE).....	136
14.16	MAINTENANCE CYCLE	137
14.17	FRONT PANEL INHIBITION	138
15	ADVANCED MARINE FUNCTIONS.....	139
15.1	HEAVY CONSUMER	139
15.2	NON-ESSENTIAL CONSUMER TRIP.....	142
15.3	CONNECTING MULTIPLE UNITS TO THE SHORE.....	146
16	TEXT FILE & PLC	147
16.1	INTRODUCTION	147
16.2	VARIABLE NAMING	147
16.3	TEXT FILE DESCRIPTION	148
16.4	WRITING CUSTOM PLC EQUATIONS	155
16.5	GENSYS 1.0 – GENSYS 2.0 COMPATIBILITY.....	157
16.6	RESETTING TO FACTORY PARAMETERS.....	159
16.7	DOWNLOAD A CUSTOM LANGUAGE FILE	159
17	COMMUNICATION	160
17.1	CAN BUS GOOD PRACTICES	160
17.2	COM1: CRE TECHNOLOGY INTER-MODULES CAN BUS.....	162
17.3	COM2: CAN PROTOCOLS (CANOPEN, J1939, MTU MDEC):.....	169

17.4	COM3: USB	187
17.5	COM4: ETHERNET	187
17.6	COM5: MODBUS RTU ON SERIAL PORT RS485	189
17.7	COM6: SD CARD	193
18	SUPPORT/TROUBLESHOOTING.....	200
19	MENU OVERVIEW.....	203
19.1	MENU INTRODUCTION	203
19.2	DISPLAY MENU.....	203
19.3	CONFIGURATION MENU.....	210
19.4	SYSTEM MENU.....	233
19.5	DEDICATED SCREENS.....	241
20	USEFUL INFORMATION.....	244
21	PRECAUTIONS	246
22	REFERENCES	248
22.1	PRODUCT REFERENCE.....	248
22.2	OPTIONS	248
22.3	ACCESSORIES.....	249
23	CRE TECHNOLOGY	250

List of figures

Figure 1 – Panel cut-out.....	16
Figure 2 – GENSYS 2.0 CORE mounting dimensions.....	17
Figure 3 – GENSYS 2.0 front panel.....	21
Figure 4 - GENSYS 2.0 MARINE front panel.....	21
Figure 5 – Rear panel.....	27
Figure 6 – User interface.....	34
Figure 7 – Default screen saver.....	34
Figure 8 – Password input mode display.....	35
Figure 9 – Main menu.....	36
Figure 10 – Browser link description.....	36
Figure 11 – Contextual keys for input mode.....	37
Figure 12 - CRE Config software.....	38
Figure 13 - Typical GENSYS 2.0 Web pages.....	39
Figure 14 - Ethernet configuration page.....	43
Figure 15 - Assisted manual mode without main paralleling.....	45
Figure 16 - Assisted manual mode with main paralleling.....	46
Figure 17 – Typical start sequence for fuel engines.....	49
Figure 18 – Power plant in change-over mode without paralleling.....	51
Figure 19 – Typical sequence in change-over mode on mains failure.....	52
Figure 20 - Typical sequence in change-over mode on start request.....	53
Figure 21 – Power plant in change-over without paralleling.....	54
Figure 22 - Power plant with several generators.....	55
Figure 23 - Generator paralleling with parallel lines.....	56
Figure 24 - Static paralleling with 4 generators coupled together in emergency situation.....	57
Figure 25 - Example with 4 generators paralleled together in emergency situation.....	57
Figure 26 - Paralleling with mains.....	59
Figure 27 - Typical sequence in No Break CO mode on start request.....	60
Figure 28 - Typical sequence in No Break CO mode on mains failure.....	61
Figure 29 - Typical sequence in permanent mode on mains failure.....	62
Figure 30 - Typical sequence in permanent mode on start request.....	63
Figure 31 - Power plant paralleling with mains.....	64
Figure 32 - GCR ↔ GENSYS 2.0 wiring diagram.....	65
Figure 33 - Power plant paralleling with several mains.....	66
Figure 34 - Minimum wiring diagram.....	67
Figure 35 - Complete wiring diagram.....	68
Figure 36 – Mounting kit.....	69
Figure 37 - Mounting brackets on GENSYS 2.0.....	69
Figure 38 - Earth grounding.....	70
Figure 39 – Power supply circuit breaker.....	70
Figure 40 - Interconnection of all battery negatives.....	71
Figure 41 - Speed output.....	75
Figure 42 – Connection with EFC Cummins.....	78
Figure 43 - PWM dynamic.....	79
Figure 44 - Caterpillar PEEC and ADEM connections.....	80
Figure 45 - Speed and voltage control with Contacts / Pulses.....	80
Figure 46 - Speed and voltage control pulses.....	82
Figure 47 - Voltage output.....	83
Figure 48 - Breakers wiring.....	86
Figure 49- Undervoltage coil.....	88
Figure 50 - Connections for water preheat, pre lubrication and pre glow.....	90
Figure 51 - Connection for air fans.....	91
Figure 52 - Connections for filling.....	92
Figure 53 - Fuel filling diagram.....	93
Figure 54 - Filling example.....	94
Figure 55 - Wiring parallel lines.....	95
Figure 56 - Change over with one digital input setup as "Mains electrical fault".....	117
Figure 57 - Permanent Mains paralleling with one digital input setup as "Mains electrical fault".....	118

Figure 58 - Permanent Mains paralleling and generator electrical fault.....	119
Figure 59 - Wiring GENSYS 2.0 and Auto Start Module	120
Figure 60 - External start sequence	121
Figure 61 - Wiring GENSYS 2.0 to BSM II	125
Figure 62 - Wiring GENSYS 2.0 ⇔ TEM.....	128
Figure 63 - Typical GPID controller	130
Figure 64 – Standard mode - example with a 4x100kW power plant.....	132
Figure 65 – Optimised mode - example with a 4x100kW power plant.....	132
Figure 66 – Automatic load/unload.....	133
Figure 67- Automatic load/unload sequence with Custom E1617 mode.....	134
Figure 68 - Phase offset example.....	135
Figure 69 - Voltage system	136
Figure 70 - Heavy Consumer Control with active power analysis.....	141
Figure 71 - Heavy Consumer Control with number of gensets analysis.....	141
Figure 72 – Heavy consumer: typical wiring	142
Figure 73- Non essential consumer trip output setting	143
Figure 74: Non-essential consumer trip (on kW)	144
Figure 75: Non-essential consumer trip (on Hz).....	145
Figure 76: Shore connection using Selco T4000.....	146
Figure 77 - Network topologies.....	160
Figure 78 - Example of CAN connection between 3 modules.....	161
Figure 79- Example CAN bus fault	163
Figure 80 -Broadcasting data between multiple units.....	163
Figure 81 - Analogue and digital data broadcast example.....	166
Figure 82 - CAN bus inhibition schematic (example)	168
Figure 83 - Modular remote CANopen I/O extension module	170
Figure 84 - CANopen coupler wiring	170
Figure 85 - MDEC: GENSYS 2.0 connexion	183
Figure 86 – MDEC Screens	185
Figure 87 – Synchroscope	207
Figure 88 – Modification by variable number.....	232
Figure 89 - Modbus rights access screen	237
Figure 90 – Compilation result screen.....	240
Figure 91 – Download logo screen.....	240
Figure 92 – Faults screen	242
Figure 93 – Information screen.....	243
Figure 94 – Speed regulation details.....	244
Figure 95 – Voltage regulation details.....	245
Figure 96 - Several generators warning.....	246
Figure 97 - One generator with mains warning.....	246
Figure 98 – Access to CRE Technology	250
Figure 99 - CRE Technology distributors	251

List of tables

Table 1 – Digital input functions	18
Table 2 - LCD screen characteristics.....	22
Table 3 – Display panel keys	23
Table 4 – Service panel keys	24
Table 5 – Control panel keys.....	25
Table 6 – Control panel led	26
Table 7 –Inputs/ outputs description	33
Table 8 – Authorization levels and passwords	35
Table 9 – Typical basic change-over configuration	51
Table 10 - Typical no change over basic configuration	54
Table 11 - Typical basic multi Generator configuration	55
Table 12 - Typical basic configuration for GENSYS 2.0 with parallel line modules	56
Table 13 - Paralleling with mains.....	58
Table 14 - Typical basic mains paralleling configuration	60
Table 15 - Paralleling with mains configuration	64
Table 16 - GENSYS 2.0 / GCR configuration	65
Table 17 - Power plant paralleling with several mains configuration	66
Table 18 - Speed governor parameters.....	78
Table 19 - PWM parameters.....	79
Table 20 - Parameters speed and voltage control with Contacts / Pulses.....	80
Table 21 - AVR: Gain and offset.....	83
Table 22 - AVR parameters	85
Table 23 - Used variables for breakers setting	86
Table 24 - Breaker control configuration	87
Table 25 – Filling parameters in automatic mode	92
Table 26 - Filling parameters in automatic mode with equations	93
Table 27 - Input parameters	96
Table 28 - Input validity domain	97
Table 29 - Input direction domain.....	97
Table 30 - Input functions	100
Table 31 - Digital outputs function	104
Table 32 - Oil pressure calibration points	106
Table 33 - Water Temp calibration points	106
Table 34 – Potential Alarm/Fault list	113
Table 35 –Integral inhibition.....	116
Table 36 -Mains electrical fault	117
Table 37 - Generator electrical fault.....	119
Table 38 - Wiring GENSYS 2.0 and Auto Start Module.....	120
Table 39 - Wiring GENSYS 2.0 ↔ TEM	129
Table 40 – Use of [E1617]parameter	134
Table 41 - Voltage system.....	136
Table 42 - Front panel inhibition.....	138
Table 43 - Settings heavy consumer	140
Table 44 – Useful variables on heavy consumer.....	140
Table 45 - Settings non-essential consumer	143
Table 46 - Label definition bloc.....	150
Table 47 - Custom logo labels.....	150
Table 48 - Accuracy codes.....	151
Table 49 – Units codes	151
Table 50 - Variables with customizable unit/accuracy values	153
Table 51 - DB9 pin out	160
Table 52 - Maximal length / communication speed	161
Table 53 - Speed communication (COM1 & COM2).....	161
Table 54 - CAN bus fault	162
Table 55 - Broadcast data sent on inter module CAN bus	164
Table 56 - Broadcast data received from inter module CAN bus	165
Table 57 - Analogue and digital data broadcast example	166

Table 58 - CAN bus inhibition variables	167
Table 59 - Tie breaker example.....	168
Table 60 - CANopen input and output variables.....	171
Table 61 - CANopen configuration example	172
Table 62 - J1939: Analog measure or J1939	173
Table 63 - J1939: Manufacturer/ECU list.....	174
Table 64 - J1939: Measurement list	177
Table 65 - Unknown SPN/FMI.....	178
Table 66 - J1939: Alarms/faults list	179
Table 67 - J1939: trames RX custom.....	180
Table 68 - J1939: Custom engine configuration.....	181
Table 69 - MDEC connexion	183
Table 70 - Important parameters	184
Table 71- Modbus functions handled	189
Table 72: 32 bits variables (Use function 0x10).....	190
Table 73 - Modbus configuration parameters	190
Table 74 - COM5 terminals	190
Table 75 - Modbus parameters for Alarm/Fault management	191
Table 76 - Modbus communication example.....	192
Table 77 - SD card backup - File size.....	196
Table 78 - Active timers 1/2	209
Table 79 - Active timers 2/2.....	209
Table 80 - Power plant configuration.....	211
Table 81 - Load dependant start/Stop Configuration	212
Table 82 - Heavy consumer control menu.....	213
Table 83 - Non essential consumer trip menu.....	214
Table 84 - Generator 1/2 Configuration	215
Table 85 - Generator 2/2 Configuration	215
Table 86 - Generator electrical fault Configuration	216
Table 87 - AVR control Configuration	216
Table 88 - Mains/Bus Configuration	217
Table 89 - Mains electrical fault configuration	217
Table 90 - External/internal start sequence configuration	218
Table 91 - Crank configuration parameters	218
Table 92 - Checking before starting configuration.....	218
Table 93 - Speed control settings configuration	219
Table 94 - Speed governor control configuration.....	219
Table 95 - J1939/MDEC configuration	220
Table 96 - J1939 protection configuration	220
Table 97 - Generator protections configuration	221
Table 98 - Mains protections configuration.....	222
Table 99 - Engine/battery protections configurations	222
Table 100 - Digital outputs configuration	224
Table 101 - Relay outputs configuration.....	224
Table 102 - Breakers configuration.....	224
Table 103 - Engine timers configuration	226
Table 104 - Mains timers configuration.....	227
Table 105 - Synchro check relay configuration	227
Table 106 - Phase synchro PID configuration.....	228
Table 107 - kW sharing loop PID configuration	229
Table 108 - Ramp/constant kW PID configuration	229
Table 109 - PID Hz loop configuration	230
Table 110 - PID kVAR sharing loop.....	230
Table 111 - PID cos(φ) loop configuration	230
Table 112 - Reset of maintenance cycle.....	231
Table 113 - Date and time settings.....	233
Table 114 - Meters reset	233
Table 115 - Meters preset	234
Table 116 - Screen saver mode	235

<i>Table 117 – Screen saver</i>	<i>235</i>
<i>Table 118 – Language selection.....</i>	<i>236</i>
<i>Table 119 – Ethernet configuration</i>	<i>237</i>
<i>Table 120 – Modbus configuration.....</i>	<i>237</i>
<i>Table 121 – SD card configuration.....</i>	<i>238</i>
<i>Table 122 – GENSYS 2.0 product reference.....</i>	<i>248</i>
<i>Table 123 - Cable reference</i>	<i>249</i>
<i>Table 124 - CRE Technology product reference</i>	<i>249</i>

1 OVERVIEW

1.1 EUROPEAN UNION DIRECTIVE COMPLIANCE CE

The EMC Directive (89/336/EEC) deals with electromagnetic emissions and immunity. This product is tested by applying the standards, in whole or in part, which are documented in technical construction file CEM 2004/108/EC, which replaces directive CEM (89/336/EEC) relative to electromagnetic emissions as from July 20th 2009.

This product is developed to respect harmonized norms:

- ❖ EN 55099:2009
- ❖ EN 55099:2010
- ❖ EN 55088:2008
- ❖ 2006/95/EC (replaced directive 73/23/EEC since January 16th 2007).
- ❖ SAE J1939/71, /73, /31

Other standards:

- ❖ EN 61326-1: 2006 (Industrial location)
- ❖ EN 55011
- ❖ EN 61000-3-2
- ❖ EN 61000-3-3

Note: This is a class A product. In a domestic environment this product may cause radio interference. The user is responsible for taking the necessary precautions.

1.2 ENVIRONMENT

Temperature

Operating: -20...+70°C (LCD display may be slow under 0°C. Normal speed is reached when the temperature rises back above 0°C).

Storage: -30...+70°C

Humidity: 5 to 95%

Altitude 2000m maximum (according to EN 61010-1 standard)

Tropic proof circuits for normal operation in humid conditions.

Front panel: IP65 protection.

Back panel: IP20 protection.

Note: The module can be used in humid conditions, however back panel must not be subject to rain or water dripping.

1.3 CHARACTERISTICS

Size: 248x197x57mm (9.76x7.76x2.24in)

Weight: 1.9kg (4.2lbs)

Panel cut-out:

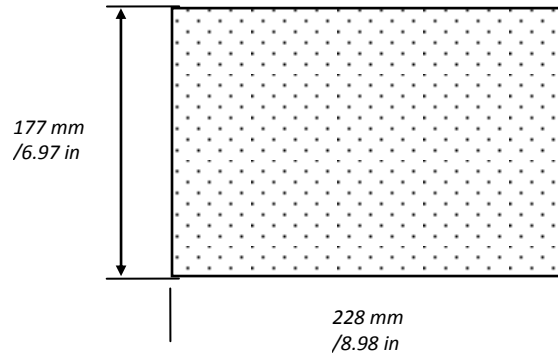

FIGURE 1 - PANEL CUT-OUT

Note: Cut-out must be cleaned and de-burred before mounting.

2 GENSYS 2.0 CORE

2.1 CHARACTERISTICS

Size: 250x200x57mm (9.84x7.87x2.24in)

Weight: 1.9kg (4.2lbs)

Mounting dimensions:

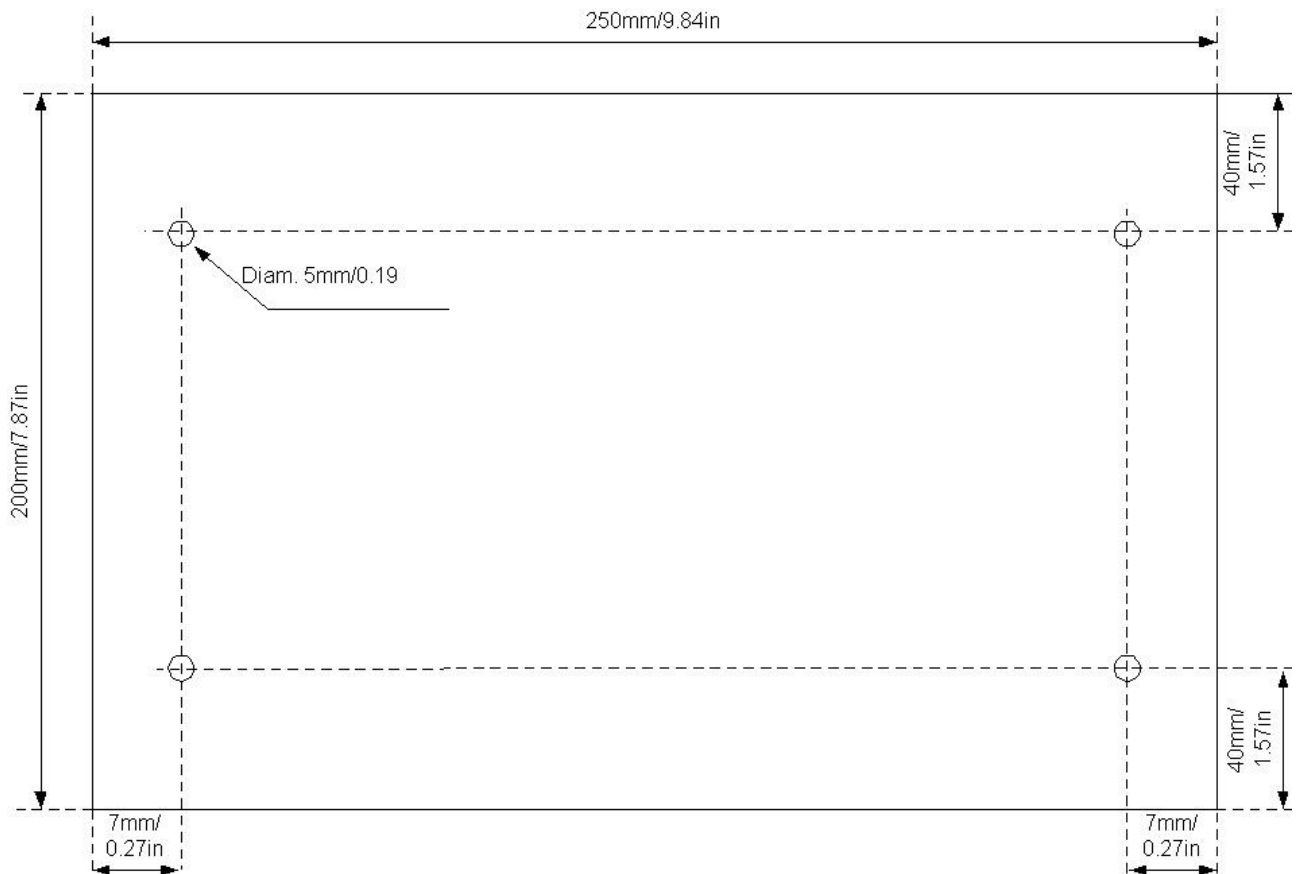

FIGURE 2 - GENSYS 2.0 CORE MOUNTING DIMENSIONS

Note: The GENSYS 2.0 CORE can be install on rail DIN.

2.2 DESCRIPTION

The GENSYS 2.0 CORE can control a single or a multiple generating sets power plant. You can combine this module with one RDM 2.0 remote display.

- GENSYS 2.0 CORE can be connected to the RDM 2.0
- GENSYS 2.0 CORE is a Generator management module
- Several power plants possibilities
- Same motherboard as the GENSYS 2.0 product family

GENSYS 2.0 CORE is able to perform all GENSYS 2.0 features.

GENSYS 2.0 CORE can be controlled using different ways:

- Connected to a RDM 2.0 remote display module.
- Remotely using your favorite Internet Web browser and by using digital inputs programmed to be used as AUTO/MAN, START/STOP, OPEN/CLOSE GENERATOR BREAKER, OPEN/CLOSE MAINS BREAKER buttons.

2.3 USER INTERFACE WITH A RDM 2.0

The RDM 2.0 is a remote display module that is connected through Ethernet to the GENSY 2.0 CORE. This way GENSY 2.0 CORE can be easily controlled and set up in the same way as a GENSY 2.0 module.

Please refer to the RDM 2.0 technical documentation “A53 Y0 9 0020 x En- Technical documentation” to connect your GENSY 2.0 CORE to a RDM 2.0.

2.4 USER INTERFACE USING DIGITAL INPUTS

According to your application, some digital inputs can be used to simulate the control panel buttons of a GENSY 2.0. You have to select the following input functions to simulate the button.

Value	Function	Description
2227	Manual start request	To be selected if a remote start command is to be installed.
2228	Manual stop request	To be selected if a remote stop command is to be installed. Note: this is not an emergency stop.
2336	Gen. breaker Close manual	To be selected if manual remote close button for genset breaker is programmed.
2337	Gen. breaker Open manual	To be selected if manual remote open button for genset breaker is programmed.
2338	Mains breaker Close manual	To be selected if manual remote close button for Mains breaker is programmed.
2339	Mains breaker Open manual	To be selected if manual remote open button for Mains breaker is programmed.
2260	Auto mode forced	GENSY 2.0 CORE will never switch to manual mode.
2261	Manual mode forced	Will switch GENSY 2.0 CORE into manual mode.

TABLE 1 - DIGITAL INPUT FUNCTIONS

3 GENSYS 2.0 LT

The GENSYS 2.0 LT is a GENSYS 2.0 that **doesn't feature** the following functionalities:

- Support of custom PLC equations.
- Support of remote CANopen inputs/outputs extension modules.



This logo appears in various chapters of this document. It indicates that the described function is not available on GENSYS 2.0 LT.

4 GENSYS 2.0 MARINE

The MARINE family includes the following units:

- A53Z3 - GENSYS 2.0 MARINE.
- A53Z4 - GENSYS 2.0 CORE MARINE.
- A53Z5 - GENSYS 2.0 LT MARINE.

The main features that distinguish MARINE units from standard industrial units are:



-  DNV type approval certificate available on MARINE units. Visit CRE Technology Web site or contact your local distributor for more details.
- Advanced load management functions (heavy consumers, non-essential load tripping).
- Uneven load sharing protection.
- No paralleling with mains.

 This logo applies to all “MARINE” units. It is used in this documentation to highlight features that are specific to marine units or applications.

 This logo applies to all “LT” units: this includes GENSYS 2.0 LT MARINE and indicates that the function described is not included in LT units.

5 DESCRIPTION

5.1 FRONT PANEL

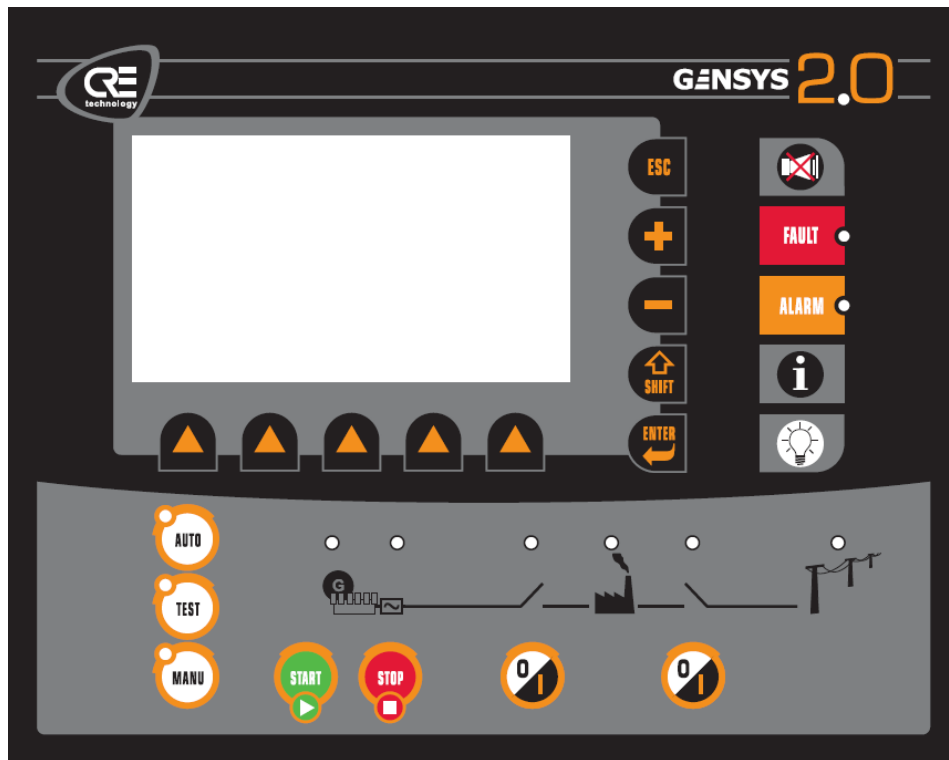

FIGURE 3 - GENSYS 2.0 FRONT PANEL

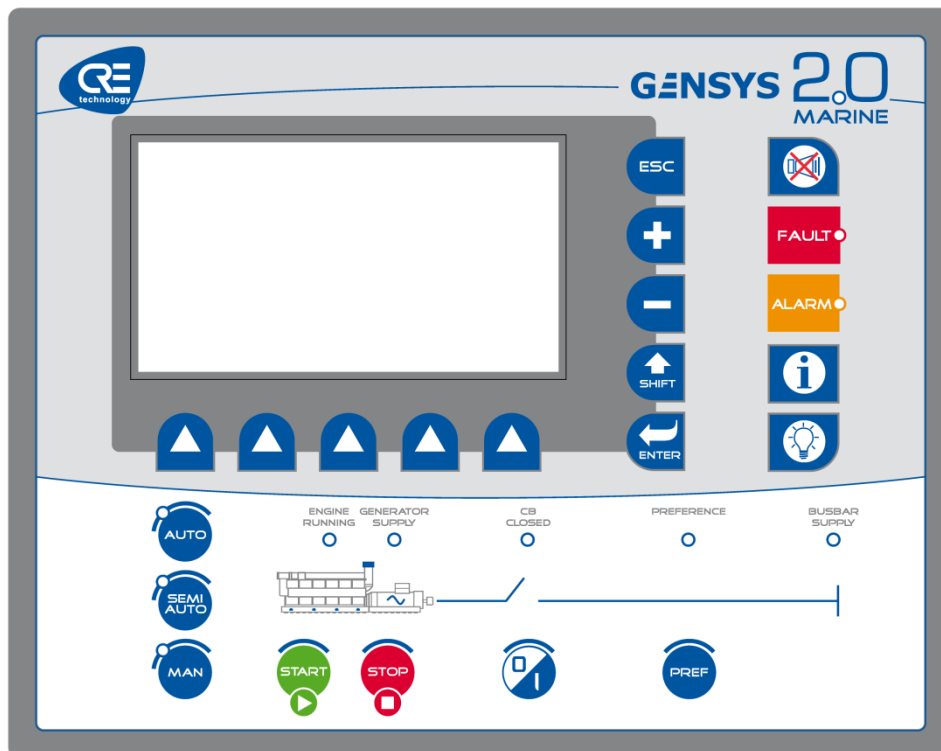

FIGURE 4 - GENSYS 2.0 MARINE FRONT PANEL

The display panel allows setting up and monitoring of the GENSYS 2.0 configuration and the power plant it controls. It provides a large LCD display and a keypad. See chapter below, for more details about the functions of LEDs & Keys.

LCD characteristics	Value	Unit
Viewing area	240x128	dots
	114x64 (4.49x2.52)	mm (in)
	30x16	Characters
Character size (small font)	2.7x3.6 (0.1x0.14)	mm (in)
(standard font)	3.6x3.6 (0.14x0.14)	mm (in)
(large font)	9.45x9.45 (0.37x0.37)	
Back light	60	cd/m ²
LCD mode	STN	

TABLE 2 - LCD SCREEN CHARACTERISTICS

5.1.1 DISPLAY PANEL

The five dedicated keys of the display panel allow direct access to special menus or functions. See chapter “User interface” for more details concerning the functions of front panel LED and keys.







Key		Navigation mode	Input mode (during parameter modification)
Navigation bar		Scroll / select menus and parameters.	Change parameter value.
Enter		Enter a menu / switch to Input mode	Validate parameter and return to 'Navigation mode'
Shift		Used with other keys only ([+], [-],).	Not used.
+		Shortcut to special function. Increase speed in manual mode. Increase voltage when associated with Shift key in manual mode.	Not used.
-		Shortcut to special function. Decrease speed in manual mode. Decrease voltage when associated with Shift key in manual mode.	Not used.
Esc		Return to parent menu.	Discard parameter changes and return to 'Navigation mode'

TABLE 3 - DISPLAY PANEL KEYS

5.1.2 SERVICE PANEL







Key		Function
Buzzer		This key will stop the alarm horn.
Fault		<p>Direct access to the Fault menu.</p> <p>An associated red LED indicates the Fault status of the generator.</p> <p>Pressing this key will switch to the associated menu, showing active faults.</p> <p>Pressing a second time on the same key will switch back to the menu displayed beforehand.</p> <p>Fault archive can be deleted in the System/ Date Time meter/. Data logging --reset menu</p>
Alarm		<p>Direct access to the Alarm menu.</p> <p>An associated orange LED indicates the Alarm status of the generator.</p> <p>Pressing this key will switch to the associated menu, showing active alarms.</p> <p>Pressing a second time on the same key will switch back to the menu displayed beforehand.</p> <p>Alarm archive can be deleted in the System/ Date Time meter/. Data logging --reset menu</p>
Info		<ol style="list-style-type: none"> 1. Direct access to global monitoring page (user configurable). 2. Save parameters in flash storage when pressed with SHIFT: this action is called "SHIFT-I" <p>Pressing this key will switch to the associated menu, which is custom made and contains parameters the user wants to monitor easily.</p> <p>Pressing a second time on the same key will switch back to the menu displayed beforehand.</p>
Bulb		LED test: pressing this key will turn on all GENSY 2.0 LEDs. It is a simple test to check the LEDs and the keypad.

TABLE 4 - SERVICE PANEL KEYS

Starting from firmware v4.55, FAULT and ALARM LED blinks when a new fault/alarm occurs. When the user displays active faults/alarms using front panel buttons  /  (or embedded Web site), associated LED stops blinking. It is kept lit if a fault/alarm is still ON otherwise it is switched off.



5.1.3 CONTROL PANEL

The control panel allows the user to pilot and control the generator. See chapter “User interface” for more details concerning the functions of front panel LED and keys.











Key		Function	
upper right LED	2.0	This LED is illuminated when a key is pressed and is switched off when all keys are released. This LED also stays on during a save parameters command (see SHIFT-I above). It is also used to indicate SD card accesses.	
Auto		Switches the system to automatic mode. Associated LED is ON when this mode is activated.	
Test		Switches the system to test mode. Associated LED is ON when this mode is activated.	
Manu		Switches the system to manual mode. Associated LED is ON when this mode is activated. This mode can be set as 100% manual mode or assisted manual mode: see corresponding chapters for more details.	
Start		Starts the generator (only available in manual mode).	
Stop		Stops the generator (only in manual mode).	
O/I		Closes/opens the generator breaker (only in manual mode).	
O/I		Closes/opens the mains breaker if available (only in manual mode).	
GENSYS 2.0 MARINE	SEMI AUTO		Switches the system to semi-automatic mode (also called assisted manual mode): see corresponding chapter for more details. Associated LED is ON when this mode is activated.
	MAN		Switches the system to 100% manual mode: see corresponding chapter for more details. Associated LED is ON when this mode is activated.
	PREF		PREFERENCE mode, also called PRIORITY mode will start the engine (if proper conditions are met) and keep it running on load even if load dependent start/stop conditions would stop it. Associated LED is ON when this mode is activated.

TABLE 5 - CONTROL PANEL KEYS

5.1.4 CONTROL PANEL LED







LED		Function
	Engine	 <p>Green LED lit when engine is running.</p>
	Alternator	 <p>Green LED lit when generator voltage is present.</p>
	Genset breaker	 <p>Green LED lit when generator breaker is closed.</p>
	Mains breaker	 <p>Green LED lit when mains breaker is closed.</p>
	Mains / Bus voltage	 <p>Green LED lit when voltage is present on Mains/Bus voltage inputs.</p>
GENSYS 2.0 MARINE	Genset breaker	 <p>Green LED lit when generator breaker is closed.</p>
	PREFERENCE mode	 <p>Green LED lit when the generator is running in PREFERENCE mode (also called PRIORITY mode).</p>
	Bus voltage	 <p>Green LED lit when voltage is present on Bus voltage inputs.</p>

TABLE 6 - CONTROL PANEL LED

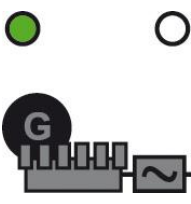
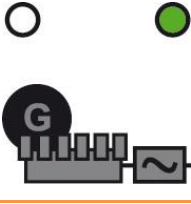
5.2 REAR PANEL - CONNECTORS

5.2.1 OVERVIEW

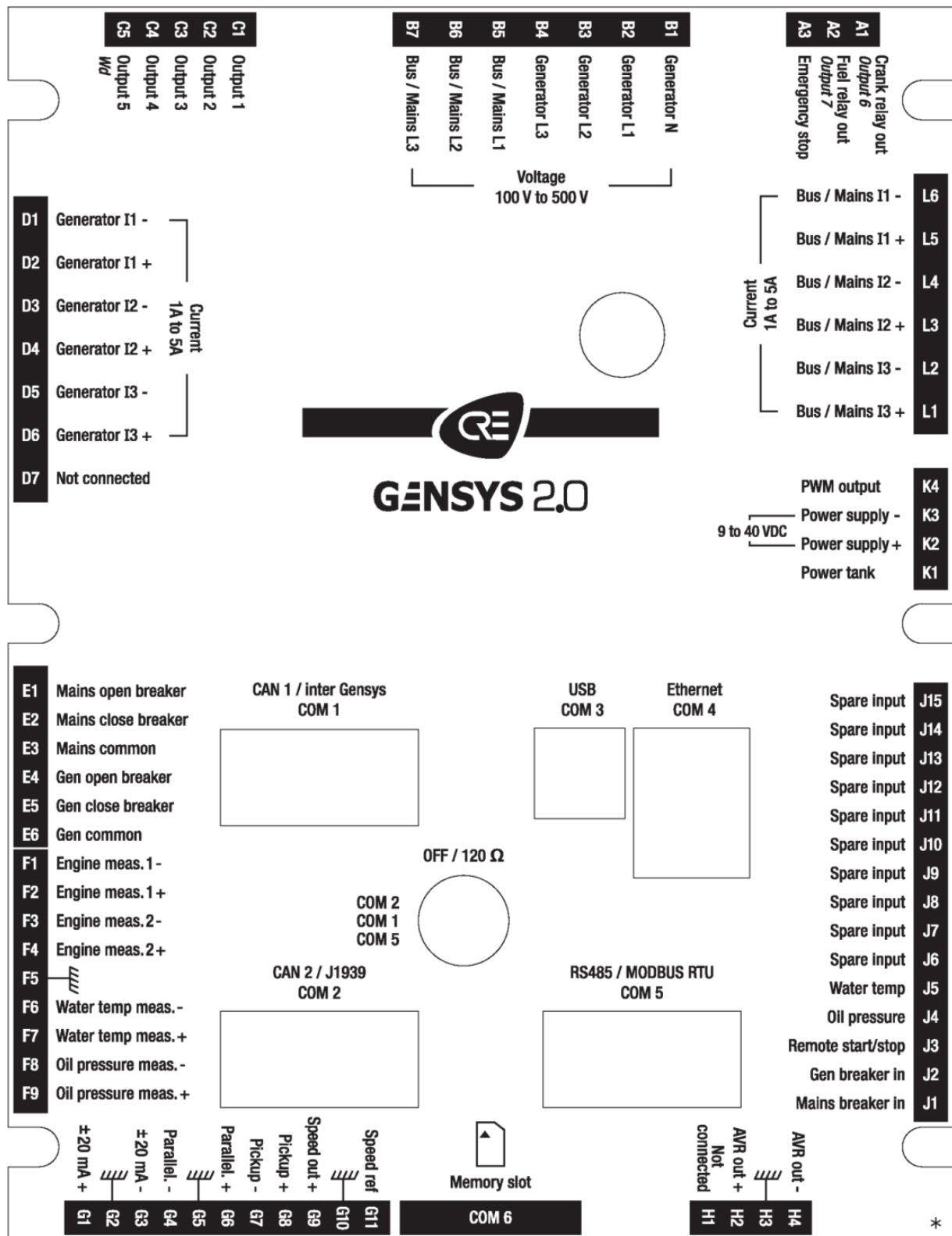

FIGURE 5 - REAR PANEL

On MARINE units:

- Logic inputs J4 and J5 are factory set as spare inputs (like J6 to J15).
- Relay outputs A1 and A2 are factory set to spare outputs (like transistor outputs C1 to C5).
- G1-G3 analogue input is factory set to +/-10V input (but can be used as +/-20mA using parameter E1461).

5.2.2 INPUTS/OUTPUTS

Terminal	Description	Terminal capacity (mm ² / AWG)	Comment
A1	Crank relay out Output 6	2.5 / 12	Supplied via emergency stop input at battery positive voltage. Can also be used as configurable relay output, see §11.4.2 5A max.
A2	Fuel relay out Output 7	2.5 / 12	Supplied via emergency stop input at battery positive voltage. Can also be used as configurable relay output, see §11.4.2 5A max.
A3	Emergency stop	2.5 / 12	To battery positive, normally closed; direct supply to crank and fuel relay outputs.
B1	Generator N	2.5 / 12	Not necessarily connected.
B2	Generator L1	2.5 / 12	Generator voltage measurement. 100 to 480 V _{AC} line to line. Frequency: 50 or 60Hz nominal, measurement from 35 to 75Hz. These lines must be protected externally with 100mA/600V _{AC} fuses.
B3	Generator L2	2.5 / 12	
B4	Generator L3	2.5 / 12	
B5	Mains L1	2.5 / 12	
B6	Mains L2	2.5 / 12	Mains voltage measurement. 100 to 480V _{AC} line to line. Frequency: 50 or 60Hz nominal, measurement from 35 to 75Hz. These lines must be protected externally with 100mA/600V _{AC} fuses.
B7	Mains L3	2.5 / 12	
C1 to C5	Output 1 to 5	2.5 / 12	Transistor output powered by the supply voltage (<350mA per output). Over current protected. Reactive load. Each output can be configured with a predefined function or programmed with custom equations, see details in §12.2.1. C5 can also be used as a watchdog output (by default).

Terminal	Description	Terminal capacity (mm ² / AWG)	Comment
D1	Generator I1-	2.5 / 12	<p>Generator current measurement 0 to 5A. Maximum rating: 15A during 10s. 1VA consumption. External current transformers are normally used. Maximum ratio is 3250 (meaning 3250:1 or 16250:5).</p>
D2	Generator I1+	2.5 / 12	
D3	Generator I2-	2.5 / 12	
D4	Generator I2+	2.5 / 12	
D5	Generator I3-	2.5 / 12	
D6	Generator I3+	2.5 / 12	
D7	Not connected	N/A	
E1	Mains open breaker	2.5 / 12	Two configurable relays with one terminal in common.
E2	Mains close breaker	2.5 / 12	<p>Factory setting uses one relay for closing and one for opening the MAINS breaker. Isolated contact. 240V_{AC}/5A. See also §11.4.1.</p>
E3	Mains common	2.5 / 12	
E4	Generating set open breaker	2.5 / 12	Two configurable relays with one terminal in common.
E5	Generating set close breaker	2.5 / 12	<p>Factory setting uses one relay for closing and one for opening the generating set's breaker. Isolated contact. 240V_{AC}/5A. See also §11.4.1</p>
E6	Generating set common	2.5 / 12	
F1	Engine meas. 1-	2.5 / 12 (shielded)	<p>0 to 10kΩ resistive sensors with programmable gain. See details in §12.3</p>
F2	Engine meas. 1+	2.5 / 12 (shielded)	
F3	Engine meas. 2-	2.5 / 12 (shielded)	<p>0 to 10kΩ resistive sensors with programmable gain. See details in §12.3</p>
F4	Engine meas. 2+	2.5 / 12 (shielded)	
F5	Shield	2.5 / 12	Must be used to protect shielded signals.
F6	Water temp meas. -	2.5 / 12 (shielded)	<p>0 to 400Ω resistive sensors. See details in §12.3</p>
F7	Water temp meas. +	2.5 / 12 (shielded)	

Terminal	Description	Terminal capacity (mm ² / AWG)	Comment
F8	Oil pressure meas. -	2.5 / 12 (shielded)	0 to 400Ω resistive sensors. See details in §12.3
F9	Oil pressure meas. +	2.5 / 12 (shielded)	
G1	±20mA + Or ±10V +	2.5 / 12 (shielded)	±10V (20kΩ input) or ±20mA (50Ω input). Used as Mains power input measurement with single generator.
G2	Shield	2.5 / 12	Used as synchronization input from GCR External analogue synchronizer (ex: GCR terminal 42 or MASTER 2.0 by parallel lines) in applications with several generators paralleled with mains. Use parameter E1461 to switch between voltage/current input.
G3	±20mA – Or ±10V -	2.5 / 12 (shielded)	
G4	Parallel. -	2.5 / 12 (shielded)	Isolated 5V (10kΩ) load sharing and power set level (kW only).
G5	Shield	2.5 / 12	Compatible with traditional analogue load share lines (often called Parallel lines).
G6	Parallel. +	2.5 / 12 (shielded)	Compatibility with Wheatstone bridge. Mainly used in applications with mixed equipments (e.g. GENSYS 2.0 with GCR or old ILS modules). See details in §0
G7	Pickup -	2.5 / 12	50Hz to 10kHz. Maximum voltage: 40V _{AC}
G8	Pickup +	2.5 / 12	Used for speed regulation, crank drop out and over-speed. See Cautions in §21. If not wired, engine speed can be measured using alternator voltage. But pickup is recommended. Also see details in speed settings §11.1.1
G9	Speed out +	2.5 / 12	G9: ±10V analogue output to speed governor.
G10	Shield	2.5 / 12	G11: ±10V reference input from speed governor (ESG).
G11	Speed ref	2.5 / 12	Compatible with most speed governors. See details in §11.1.1
H1	Not connected	2.5 / 12	Analogue output ±5V isolated.

Terminal	Description	Terminal capacity (mm ² / AWG)	Comment
H2	AVR out +	2.5 / 12	Automatic voltage regulator (AVR) control. Compatible with most regulators. Details in §11.3
H3	Shield	2.5 / 12	
H4	AVR out -	2.5 / 12	
J1	Mains breaker in	2.5 / 12	Digital input with 10kΩ pull-up dedicated to Mains breaker feedback. Accepts NO or NC contact to 0V. Not isolated.
J2	Gen breaker in	2.5 / 12	Digital input with 10kΩ pull-up dedicated to generator breaker feedback. Accepts NO or NC contact to 0V. Not isolated.
J3	Remote start/stop	2.5 / 12	Digital input with 10kΩ pull-up dedicated to remote start/stop request in Auto mode. Accepts NO or NC contact to 0V. Not isolated.
J4	Oil pressure Spare input	2.5 / 12	Digital input with 10kΩ pull-up. Default factory set as input for oil pressure fault. Accepts NO or NC contact to 0V. Not isolated. Can be programmed as a spare input. Details in §12.1
J5	Water temp Spare input	2.5 / 12	Digital input with 10kΩ pull-up. Default factory set as input for water temperature fault. Accepts NO or NC contact to 0V. Not isolated. Can be programmed as a spare input. Details in §12.1
J6 to J15	Spare input 1 to 10	2.5 / 12	Digital input with 10kΩ pull-up. 10 inputs can be configured with a specific function or programmed with PLC equations. Accepts NO or NC contact to 0V. Not isolated. See details in §12.1.
K1	Power Tank	2.5 / 12	Only used for 12V power supply backup during crank time. An external capacitor can be connected between terminal K1 (+) and K3 (-) for better tolerance to power drops. A 47.000μF capacitor can help accept a 200ms power drop depending on inputs/outputs states.
K2	Power supply +	2.5 / 12	9 to 40V, 10W consumption. Protected against

Terminal	Description	Terminal capacity (mm ² / AWG)	Comment
K3	Power supply -	2.5 / 12	polarity inversion. "Power supply -" must be wired from the speed governor via 4 mm ² wires. See "state of the art" rules wiring diagram. External 5A / 40V _{DC} fuse recommended.
K4	PWM output	2.5 / 12	500Hz PWM output. Compatible with Caterpillar and Perkins PWM controlled units. 0-5V protected against short-circuits to 0V. Details in §11.1.2
L1	Bus/Mains I3+	2.5 / 12	Bus/Mains current measurement. 1 to 5A. Maximum rating: 15A during 10s. 1VA consumption. External current transformer is normally used. Maximum ratio is 3250 (meaning 3250:1 or 16250:5).
L2	Bus/Mains I3-	2.5 / 12	
L3	Bus/Mains I2+	2.5 / 12	
L4	Bus/Mains I2-	2.5 / 12	
L5	Bus/Mains I1+	2.5 / 12	
L6	Bus/Mains I1-	2.5 / 12	
COM1	CAN1 inter GENSYS 2.0	Male DB9 (shielded)	Isolated CAN [®] bus. Proprietary protocol to communicate with other GENSYS 2.0/MASTER 2.0 units and share data/information. See details in §17.2.
COM2	CAN2 options J1939 CANopen MTU MDEC	Male DB9 (shielded)	Isolated CAN bus (125kb/s factory setting). See details in §17.3. Used to communicate with: <ul style="list-style-type: none"> • remote I/O (see §17.3.1) • J1939 ECU (see §13.3.2) • MTU MDEC protocol (see §17.3.3)

Terminal	Description	Terminal capacity (mm ² / AWG)	Comment
COM3	USB	USB Type B High Quality	<p>GENSYS 2.0 with firmware v2.00 (or later) : This port is replaced by Ethernet communication.</p> <p><i>GENSYS 2.0 with firmware v1.xx :</i> <i>Isolated type B standard USB connector. Use a standard USB A to B cable to connect with PC.</i> <i>Used for configuration, parameters, file downloading and uploading. Uses TCP/IP protocol to communicate with modem emulation.</i> <i>Not to be used while engine is running.</i></p>
COM4	Ethernet	RJ45 CAT5	<p>Standard RJ45 ETHERNET connector. Use a 100Ω cable.</p> <p>Isolated. Uses TCP/IP protocol to communicate with external world. Details in §17.5.</p>
COM5	RS485 MODBUS RTU	Male DB9 (shielded)	<p>4800, 9600 or 19200 bps.</p> <p>Used to communicate with SCADA.</p> <p>Modbus RTU slave. Read and write functions, 2 wires.</p> <p>Isolated. See details in § 17.6</p>
COM6	Memory slot	SD	Memory slot used for extensions. See details in §17.7.

TABLE 7 -INPUTS/ OUTPUTS DESCRIPTION

6 USER INTERFACE

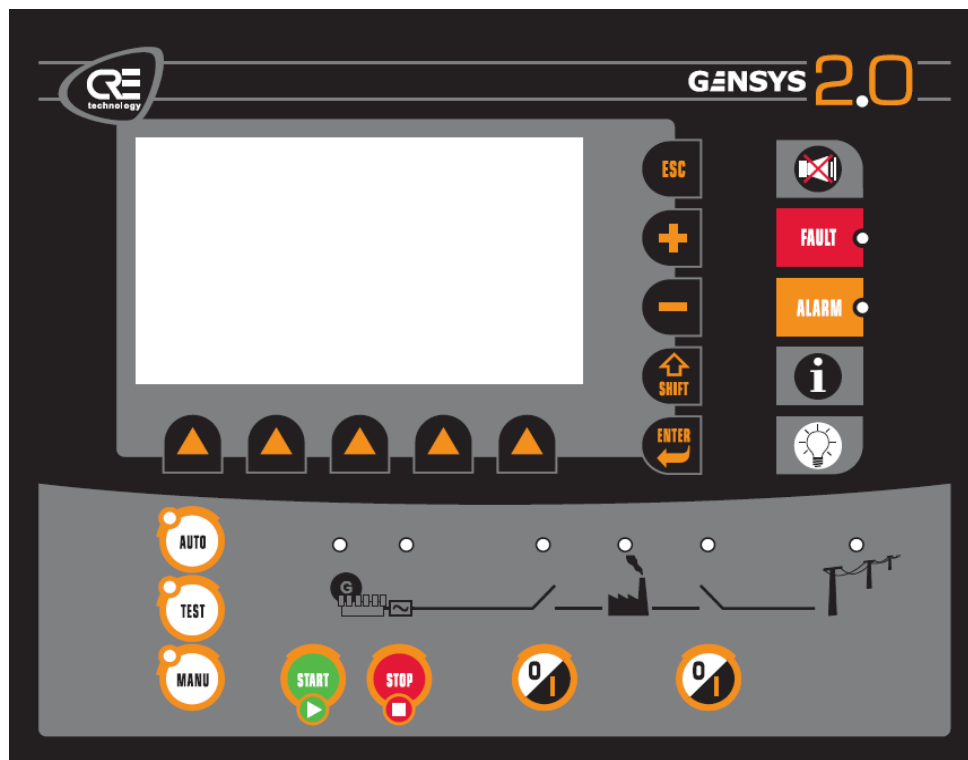

FIGURE 6 - USER INTERFACE

The user interface can be controlled using different ways:

- ❖ Directly on local browser using front panel LCD screen and keyboard.
- ❖ Remotely using dedicated **CRE Config** software or your favourite Internet Web browser.

When GENSYS 2.0 is powered up, it displays a welcome screen during a short time and then switches to the display of the generating set's status if emergency stop is activated.

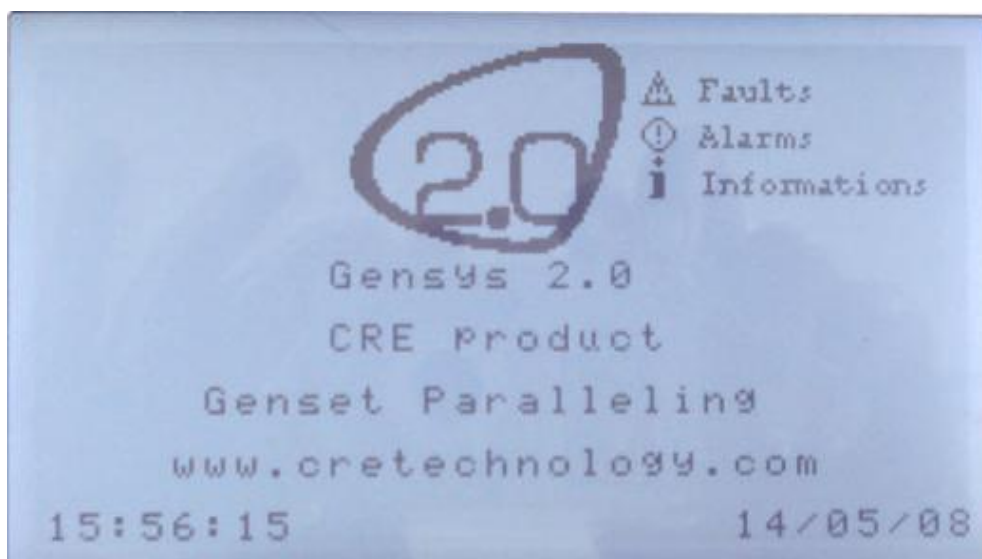

FIGURE 7 - DEFAULT SCREEN SAVER

6.1 SECURITY LEVEL AND PASSWORD

GENSYS 2.0 features password protected access levels to define which menu and parameters can be accessed. Table below details these levels and what can be accessed.

Level	Default password	Authorization	Accessible menu
-1		G59 (options) This is a special function access (see §14.10 for more details)	
0	No password. Press [ENTER] key.	This level is not password protected.	DISPLAY menu only
1	1 (digit "ONE").	User level, parameters settings & commissioning. Used to change PLC level 1 equations and parameters.	All menus
2	Reserved	PLC programming level 2. Used to change PLC level 2 equations and parameters.	All menus + advanced functions

TABLE 8 - AUTHORIZATION LEVELS AND PASSWORDS

Active and lower level passwords can be changed in the system menu (see §19.4.2).

When the password page is shown on the LCD display, the user must first press on the **[ENTER]** key to switch to password input mode (as for other parameters).

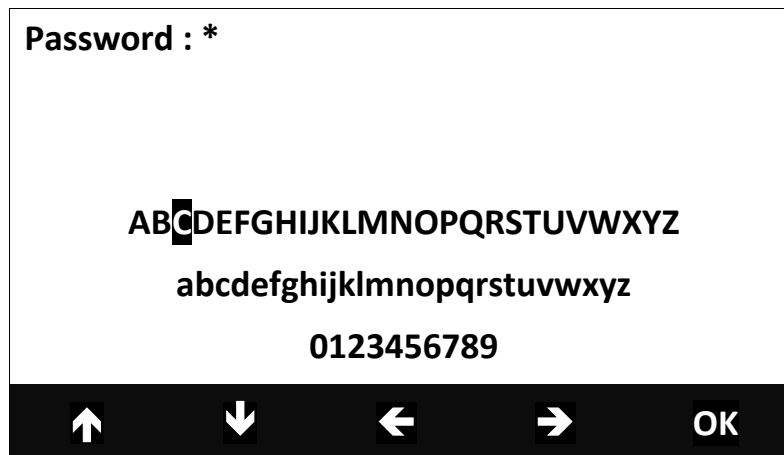

FIGURE 8 - PASSWORD INPUT MODE DISPLAY

Three lines of characters (upper and lower case letters, '0' to '9' characters) will appear along with 5 icons above the contextual keys. The first four contextual keys allow the user to move the cursor up, down, left or right onto the desired character. Key "OK" will validate the selected character and write it in the password line (a * appears for each character entered). **[ENTER]** key validates the password. If it is correct, the main menu will appear on the LCD display. Otherwise, the password page will be displayed again.

You can now enter: **[ESC] [ENTER]** and type in the level 1 password as described above so as to access the top level menu which contains three entries:

- ❖ Display.
- ❖ Configuration.
- ❖ System.

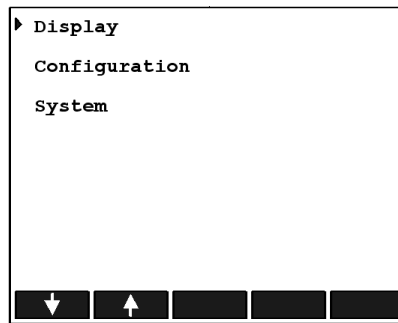

FIGURE 9 - MAIN MENU

6.2 LOCAL NAVIGATION

The 5 icons above the contextual keys will change in appearance depending on the type of parameter to modify (chosen list, label, numerical value, password...). They are referred to as the “navigation bar”, or soft keys. User can navigate through the different menus with this navigation bar and the **[ESC]** **[ENTER]** keys. Navigation bar has 5 contextual keys (soft keys). Depending on the menu displayed, different icons may appear above these keys, allowing the user to scroll up/down the pages or to select a link to a new menu or parameter.

When a parameter is selected and the user presses **[ENTER]** key, then the display switches to Input mode. In this mode, **[ENTER]** key will validate the new parameter value and return to Navigation mode while **[ESC]** key will discard parameter changes before switching back to Navigation mode.

The internal browser displays a white pointer in front of each link or parameter of a menu. A black pointer indicates the current active link or parameter. Figure 10 shows these two pointers:

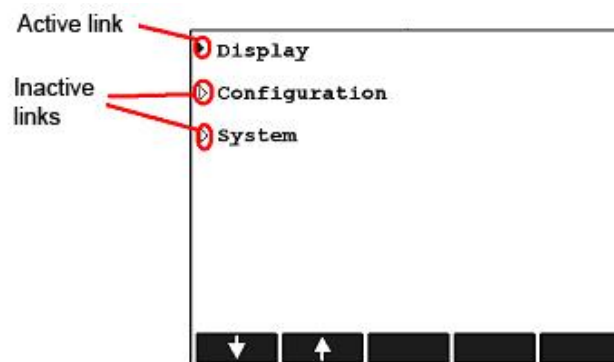

FIGURE 10 - BROWSER LINK DESCRIPTION

6.2.1 INPUT MODE

To change a parameter, first select it with the contextual keys and then press [ENTER] to switch to 'Input mode'. New icons will appear above the contextual keys, depending on the kind of parameter selected.

Label modification:	
Digital value modification:	
Option modification:	

FIGURE 11 - CONTEXTUAL KEYS FOR INPUT MODE

When the new parameter value is set press [ENTER] to store and confirm the new value.

6.2.2 SAVING ACTUAL CONFIGURATION



Starting from firmware version v4.00, the module executes an **automatic backup of the parameters** in a non-volatile memory (except for parameters modified through Modbus). So manual backup methods described below are not necessary but are still working.

In GENSYS 2.0 using firmware versions older than v4.00, parameters used in configuration are stored in a FLASH memory. When a parameter is changed by the user, the new value is stored in a RAM memory. The new value will be effective as soon as it is entered, but it will be lost if power supply is lost. Here is how to permanently save parameters:

- ❖ Press **Shift** and **I** front keys at the same time.



Starting from firmware v3.00, two additional methods are available to permanently save parameters in memory:

- ❖ Go to menu *System/Shift+I* (or use Shift+I link at the bottom of any page displayed in your PC) and select **Shift+I** link.

Shift + I

Cliquer sur Shift+I pour stocker les parametres en flash

[Shift + I](#)

[Esc](#)

[Defaults](#)

[Alarmes](#)

[Information](#)

[Shift + I](#)

- ❖ Using Modbus, you can process as follows:
 - Write 0 (zero) into parameter [E4066].
 - Write 1 (one) into parameter [E4066] to initiate backup.
 - Wait 3 seconds and read parameter [E4066]. A value of 2 (two) means that parameters were successfully saved into FLASH memory.

Note: Parameter [E4066] must first be set as write enabled to be modifiable via Modbus. See Modbus chapter for more details.



NOTE:

Back-up procedure may take a few seconds. It is thus essential to save parameters while engine is stopped. NEVER SHUT DOWN YOUR MODULE DURING STORAGE SEQUENCE (ORANGE LED ILLUMINATED).

6.3 REMOTE CONTROL USING A PC (ETHERNET CONNECTION)

6.3.1 COMPATIBILITY WITH CRE CONFIG SOFTWARE



Starting from firmware v3.00 GENSYS 2.0 can be monitored and controlled using **CRE Config** software. This software features a user friendly interface to monitor measurements and set up GENSYS 2.0 parameters. You can download **CRE Config** software from CRE technology Web site <http://www.cretechnology.com>. Please refer to **CRE Config** software documentation for more details.

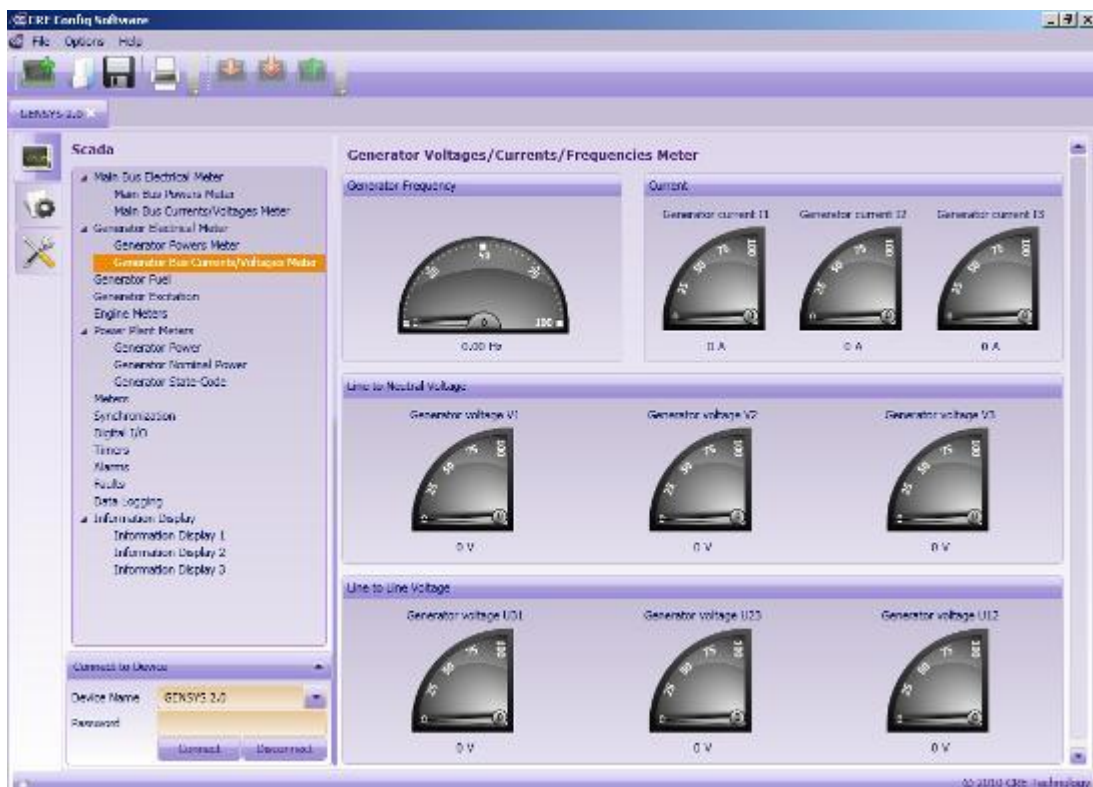
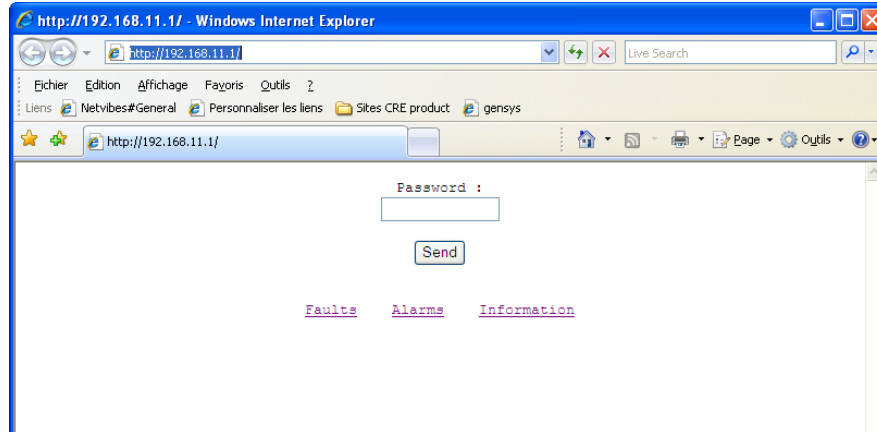

Figure 12 - CRE Config software

6.3.2 GENSYS 2.0 INTERNAL WEB SERVER

- ❖ Connect GENSYS 2.0 to your computer using an Ethernet **cross over cable**.
- ❖ Start your Web browser (Ex: Firefox or Internet Explorer).
- ❖ Type in the GENSYS 2.0 URL or IP address (factory settings <http://gensys> or <http://192.168.11.1>) according to your GENSYS 2.0 and Windows **hosts** file settings.



⇒ GENSYS 2.0 password page appears. Enter your password to browse GENSYS 2.0 Web site.

Note: Parameter [E4042] serves as a Web connection timeout delay. Once this time is elapsed without any Web communication, the password will be asked for again.

GENSYS 2.0 internal Web server is a very easy and efficient way of setting up your module. Various menus can be accessed via a Web browser such as Firefox or Internet Explorer as shown in the screenshots below.

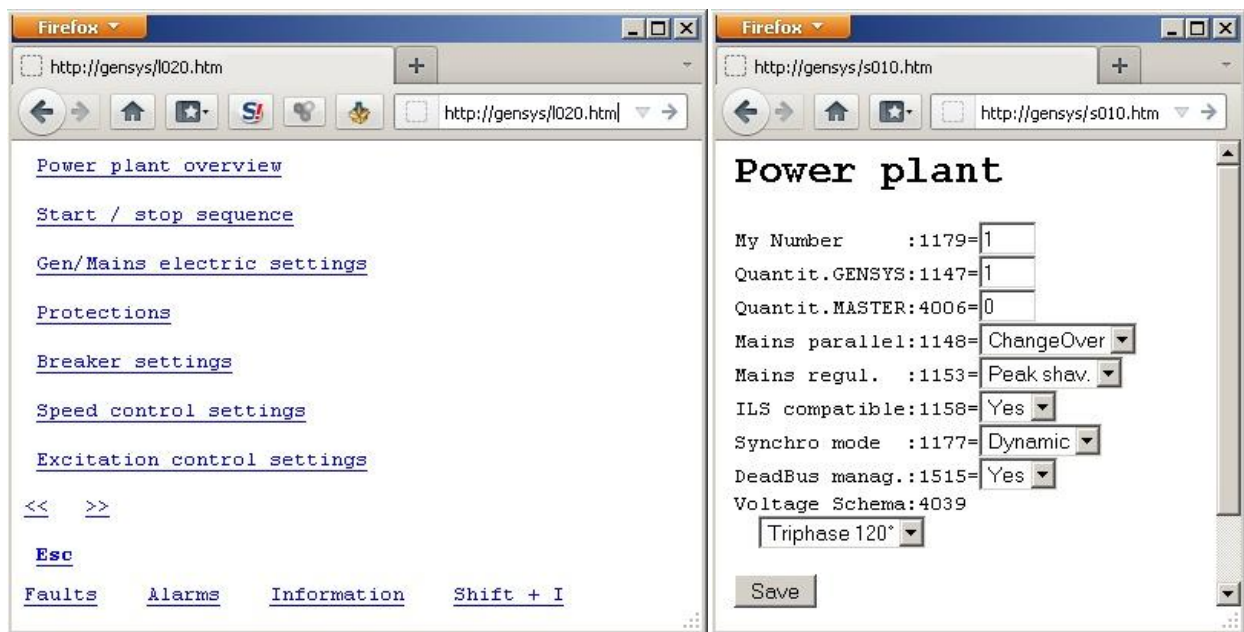

FIGURE 13 - TYPICAL GENSYS 2.0 WEB PAGES

Left page shown above gives access to 6 subpages (“Protections” for example). Right page shows different kinds of parameters (numerical values, list of choice) that can be modified and then sent back to the module using **Save** button.

Web links **<<** and **>>** give access to other pages of the current menu, **Esc** link leads back to the upper level menu.

Bottom links are identical to the Fault / Alarm / Information keys on the GENSYS 2.0 front panel.

6.3.3 DOWNLOADING A TEXT FILE

When you are connected with a computer, a text file can be transferred between the GENSY 2.0 and the PC. This allows the following actions:

- ❖ Upload new parameters to the GENSY 2.0.
- ❖ Upload new equations to the GENSY 2.0.
- ❖ Download parameters from the GENSY 2.0 (as a backup for you).
- ❖ Download equations from the GENSY 2.0 (as a backup for you).

Data that can be transferred depends on your access level. For more information concerning text files please refer to §16.3.

6.3.4 ETHERNET SETUP OF YOUR COMPUTER

With Windows XP:

- ❖ Open the control panel.
- ❖ Click on network connections.
- ❖ Click on local network.

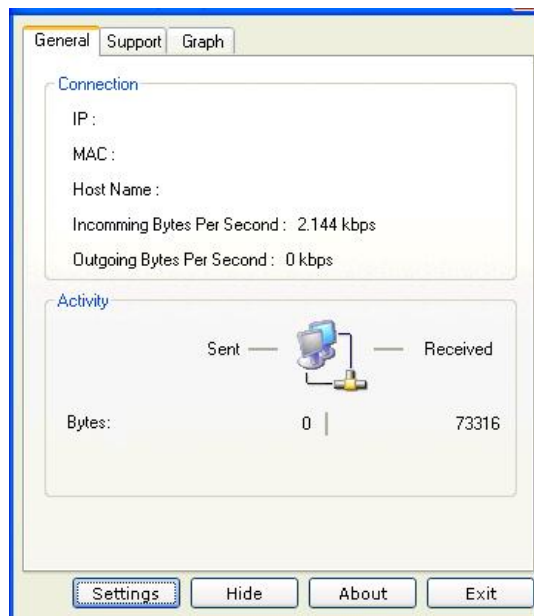

- ❖ Click on « Settings ».

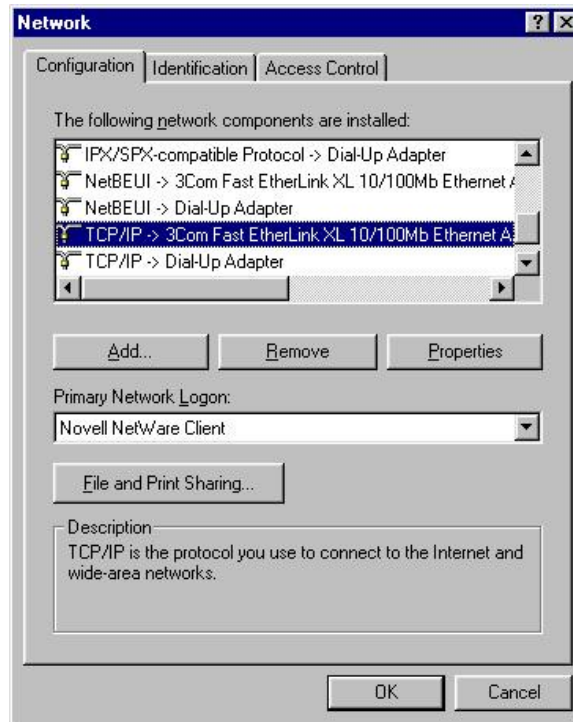

- ❖ Select « Ethernet (TCP/IP) ».
- ❖ Properties.

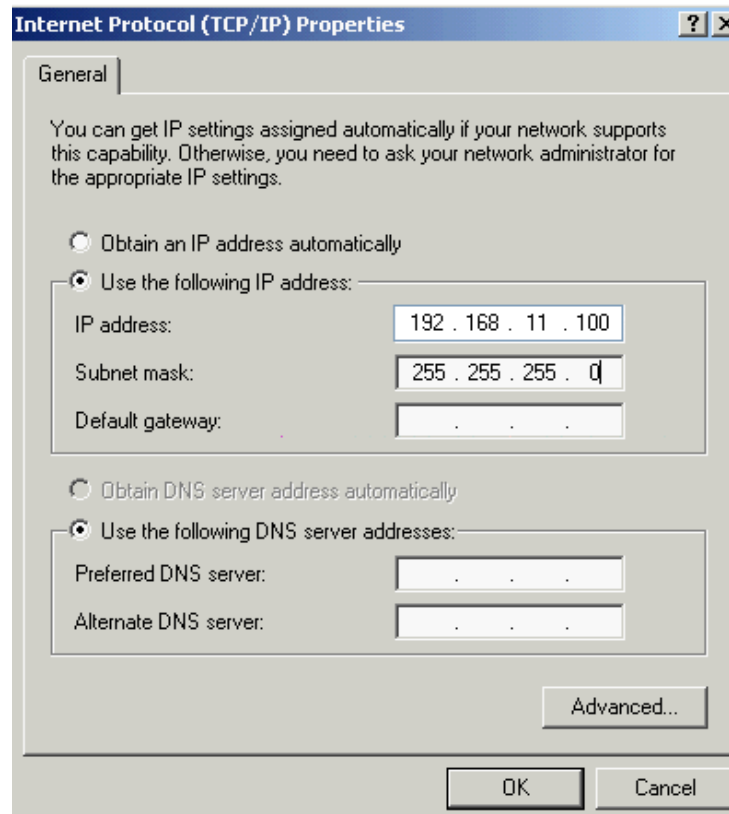

- ❖ Enter the addresses as shown above.

Note: IP address 192.168.11.100 shown above can be used if GENSYS 2.0 IP address is 192.168.11.1 (factory setting). Otherwise, computer and GENSYS 2.0 IP addresses should match the same subnet mask as shown below.

Example:

Subnet mask: 255.255.255.0
Computer IP address: AAA.BBB.CCC.XXX
GENSYS 2.0 IP address: AAA.BBB.CCC.YYY

- ❖ Click on OK.
- ❖ Close the networking windows.
- ❖ Create/Modify Windows **hosts** file as explained below.

Windows **hosts** file can be found in “C:\WINDOWS\system32\drivers\etc”. It can contain lines to link GENSYS 2.0 IP addresses to hostnames. For example:

#Factory IP address of GENSYS 2.0:

```
192.168.11.1    gensys    #generic IP address and hostname (factory settings).  
#Example of 4 GENSYS 2.0 connected to an intranet:  
192.168.123.101 genset1   #place optional comments here  
192.168.123.102 genset2   #800kVA engine  
192.168.123.103 genset3   #450kVA engine  
192.168.123.104 genset4   #320kVA engine
```

When trying to change the host file with Windows Vista, you may come across a warning message like those shown below:

Warning message 1



Access to C:\Windows\System32\drivers\etc\ hosts was denied

Warning message 2

Cannot create the C:\Windows\System32\drivers\etc\hosts file.

Check that the file's name and location are correct.

This problem may occur even if you are the system administrator. To solve this problem, follow these steps:

1. Click on Windows start button () then select **All Programs, Accessories**, right click on Notepad, and select **Run as administrator** (). If you are prompted for an administrator password or for a confirmation, type in the password, or click **Allow** button.
2. Open the **Hosts** file, make the necessary changes, and then click **Save** on the **Edit** menu.

Notes on Ethernet connection

If you change the IP address of a GENSYS 2.0, you should also adapt Windows hosts file to be able to use the hostname (http://gensys/ or any other hostname of your choice) in your Web browser. Otherwise you will have to directly type the IP address of the GENSYS 2.0 you want to connect to in your Web browser.

If your computer is connected to your company intranet and you cannot or don't want to change its network settings, CRE Technology can provide a USB-Ethernet converter to setup a second network configuration on your computer dedicated to GENSYS 2.0 communication. Reference of this module is A53W2.

6.3.5 CHANGING GENSYS 2.0 IP ADDRESS

GENSYS 2.0 IP address can be changed in configuration page **System/Communication ports config/COM4 (ETHERNET)**.

GENSYS 2.0 also handles DHCP function: in this case, GENSYS 2.0 must be connected on a network that provides a DHCP server. During the power on sequence, GENSYS 2.0 will be assigned its IP address by the DHCP server. If DHCP process fails, the fixed IP address will be used (factory set to 192.168.11.1).

*Note: Once the new IP address is entered or DHCP use is changed, you will **need to restart the module** for the new settings to take effect.*

Chargement...

COM4 (ETHERNET)

Re-start module to validate the update

Use DHCP : Disable

IP Address : 192 168 11 1

IP GW Address : 0 0 0 0

Communication ports

TCP : 4081=80

UDP : 4082=7024

ModbusTCP : 4083=502

Save

<< >>

Esc

[Faults](#) [Alarms](#) [Information](#) [Save modified parameters](#)

FIGURE 14 - ETHERNET CONFIGURATION PAGE



ADVICE:

Please contact your network administrator to configure your router and module(s) according to your need.

7 OPERATING MODE

There are 4 main operating modes to allow you to control your generator. The first 3 are standard modes on industrial units. These operating modes are:

- ❖ Automatic mode.
- ❖ Test mode.
- ❖ Assisted manual mode (also called semi-automatic mode).
- ❖ 100% manual mode. This mode must be enabled by setting parameter [E1621] to 0.

GENSYS 2.0 MARINE

On MARINE units, standard modes are:

- Automatic mode.
- Semi-automatic mode (also called assisted manual mode).
- 100% manual mode.

They are factory set and should not be changed.

7.1 ASSISTED MANUAL MODE



Assisted manual mode is a kind of automatic mode where main state transitions are manually triggered by pressing the desired front panel button. This mode is available from v4.00 software version.

User control:



Use **[MANU]** button to activate this mode. Corresponding LED will light on.

GENSYS 2.0 MARINE

Assisted manual mode is also called semi-automatic mode. On MARINE units, press on

front panel  to activate this mode.



[START] button will launch the complete automatic start sequence of the generating set. Once ready, the engine will be let running without additional control of the GENSYS 2.0.

If a speed governor is connected to GENSYS 2.0, it is possible to increase the speed with the **[+]** key, and decrease it with the **[-]** key.

If a voltage regulator is connected to GENSYS 2.0, it is possible to increase and decrease the voltage with the **[SHIFT] + [+]** keys and **[SHIFT] + [-]** keys.



Using **[STOP]** button while generating set breaker is open will stop the engine after the standard cool down sequence. A second **[STOP]** request will stop the engine without waiting for the cool down duration.

Using **[STOP]** button while generating set breaker is closed will start the standard unload sequence, open the breaker and stop the engine after the cool down sequence.



GENERATING SET

1/ When the generating set is running, the **Open/Close generating set breaker** button will switch the generating set on load. Depending on its setup (island mode, paralleled with Mains or other generating sets...), GENSYS 2.0 will automatically use the appropriate process: synchronization (if bus bar is live), closing the generating set's breaker, loading ramp (if bus bar is live). Then it will manage the load depending on the setup (load sharing, fixed kW setpoint...).

2 / When on load, **Open/Close generating set breaker** button will set the generating set off load : unload ramp (if paralleling mode is selected) and open the generating set's breaker. The generating set will be left running until the **[STOP]** button is pressed.

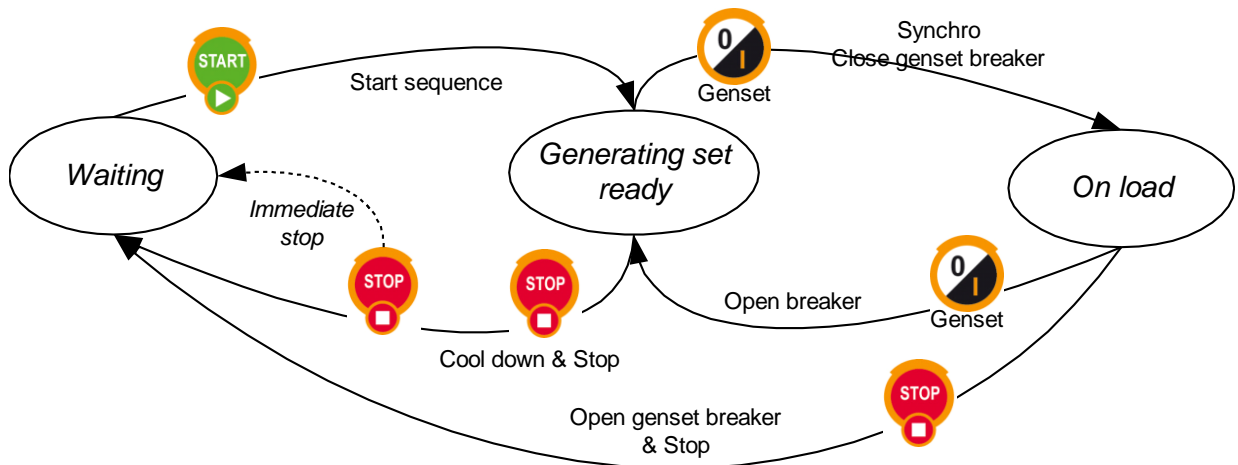

FIGURE 15 - ASSISTED MANUAL MODE WITHOUT MAIN PARALLELING



MAINS (Option 2 « Mains paralleling » must be enabled)

1/ When in « On load » state and if Mains/Bus bar is live, the use of **Open/Close Mains breaker** button will trigger the appropriate sequence depending on the power paralleling mode setup (Change over, no break change over, paralleled with Mains...): GENSYS 2.0 will synchronize the generating set (if needed), close the Mains breaker, perform a load ramp... Then it will manage the load depending on the setup : load sharing, fixed kW setpoint...

2 / When paralleled with the Mains, pressing the Open/Close breaker buttons will open the appropriate breaker and let the generating set running until **[STOP]** button is pressed.

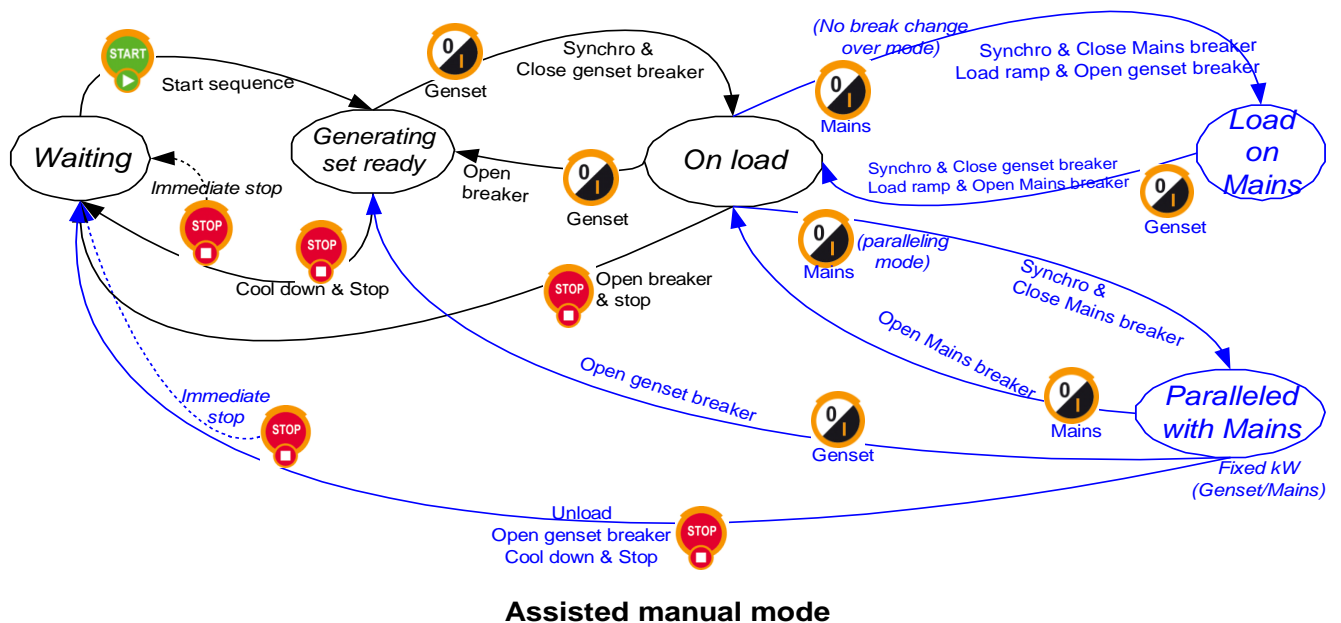

FIGURE 16 - ASSISTED MANUAL MODE WITH MAIN PARALLELING



WARNING:

As the assisted manual mode is a kind of automatic mode, variable [E2055] (Auto mode) is equal to 1 and variable [E2056] (Manu mode) is equal to 0.

To determine the actual running mode, you may prefer using LED status variables.

7.2 AUTOMATIC MODE

Speed and voltage droop are inhibited in this mode, the system is running isochronously, i.e. the speed and the voltage remain unchanged whatever the load.

This mode has 4 main ways of operating:

7.2.1 ONE GENERATOR WITH CHANGE OVER

The generator starts with a remote start or in the case of mains failure. When the generator is ready (voltage, frequency), the mains breaker is opened and the generator breaker is closed. Should the mains return to normal conditions or remote start is off, after a programmed delay the generator breaker is opened, the mains breaker is closed and the generator set is stopped.

7.2.2 ONE GENERATOR PARALLELING WITH THE MAINS

The generator starts with a remote start or if there is a mains failure. Paralleling depends on configuration:

- ❖ NO CHANGE OVER
- ❖ NO BREAK CHANGE OVER
- ❖ PERMANENT

Load sharing can be on a "base load" or "peak shaving" ("peak lopping") basis. Depending on the configuration, the generator will stop either when there is a remote stop or when mains power returns to a stable level.

7.2.3 POWER PLANT WITH SEVERAL GENERATORS WITHOUT AUTOMATIC LOAD/UNLOAD

The generator starts with a remote start signal, and parallels with the bus. If there is a dead bus, GENSYS 2.0 will check with the other GENSYS 2.0 units before closing the bus breaker (this depends on the validation of the dead bus management). The load sharing is accomplished via the inter GENSYS CAN© bus (§17.2) or via the parallel lines (§9.4). The generators stop with a remote stop signal.

7.2.4 POWER PLANT WITH SEVERAL GENERATORS WITH AUTOMATIC LOAD/UNLOAD

The communication between GENSYS 2.0 units is via the inter GENSYS CAN© bus (§17.2) and determines which generators start or stop. The number of generators used depends on load requirements (all generators receive the remote start signal but only start if necessary).

Note: The operating modes are described in the chapter 9 below.

7.3 TEST MODE

This mode allows testing automatic mode behaviour. When **[TEST]** key is pressed, the engine starts as if there was a remote start, and GENSYS 2.0 will carry out the standard automatic mode sequence to take the load (with synchronization in case of parallel mode). To exit test mode, press **[AUTO]** or **[MAN]** key on the front panel.

Note: TEST mode should only be used to check the sequence of the generating set to go on load. It cannot be used as a permanent working mode as some advanced features (such as load dependent start/stop or other functions) may not respect the standard automatic mode behaviour.

Test mode is not available on MARINE units. It is replaced by semi-automatic mode (see above).

7.4 100% MANUAL MODE

The **100% MANUAL** mode is activated by setting the parameter [E1621] to 0 (Menu « Configuration/Modification by variable n°»). Then **100% MANUAL** mode replaces the **ASSISTED MANUAL** mode that is not available anymore.

In **100% MANUAL** mode, it is possible to control the generator with the front panel of the GENSYS 2.0. All steps from engine start to paralleling are controlled by pushing keys.

To start the engine push the **[START]** key and hold down until the oil pressure fault disappears. If a speed governor is connected to GENSYS 2.0, it is possible to increase the speed with the **[+]** key, and decrease it with the **[-]** key.

If a voltage regulator is connected to GENSYS 2.0, it is possible to increase and decrease the voltage with the **[SHIFT] + [+]** keys and **[SHIFT] + [-]** keys.

As the generator starts, the synchroscope appears on the screen. It is then possible to synchronize using the **[+]** and **[-]** keys and then close the breakers with the **[O/I]** keys.

Note: The internal synch check relay is always active, i.e. it is impossible to close the breaker if the conditions for closing are not satisfied.

When the breaker is closed (Mains breaker feedback is connected) the corresponding Led on the front panel should light up.

As soon as the generator breaker is closed, the GENSYS 2.0 is switched to “DROOP MODE” for speed and voltage, i.e. the speed and the voltage will decrease when the load increases.

In droop mode, load sharing is controlled by droop but can also be managed with the **[+]** and **[-]** keys.

To stop engine push the **[STOP]** key.

On MARINE units, 100% manual mode is the standard manual mode. Simply press on

front panel  to activate this mode.

8 START SEQUENCE

During the start sequence protections are inhibited. This concerns all engine protections. When the engine reaches genset ready, the protections are activated. A timer can be added to inhibit protections during the "safety on" delay [E1514]. The timer will start when the genset is ready.

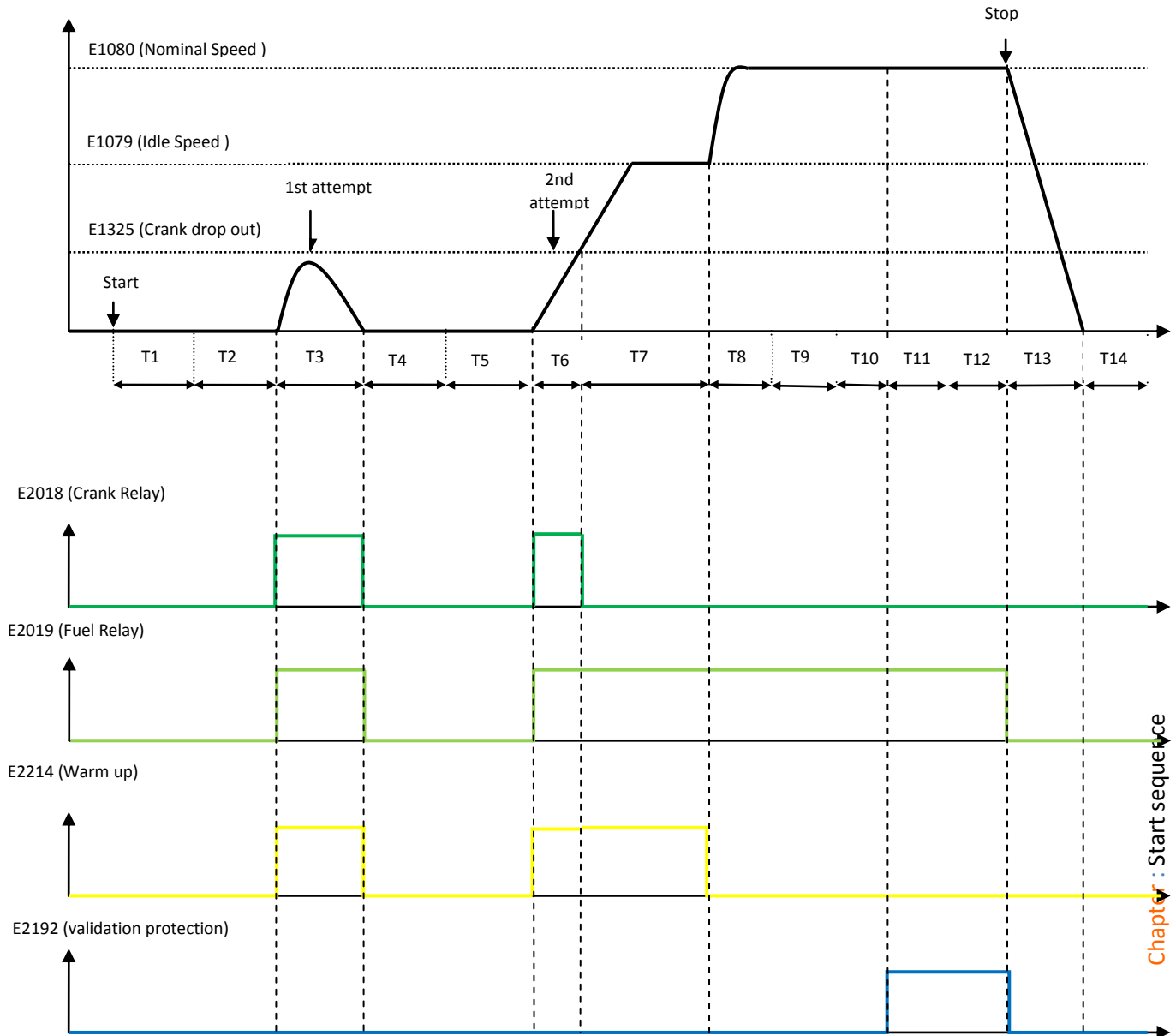

FIGURE 17 - TYPICAL START SEQUENCE FOR FUEL ENGINES

- T1 : Prelubrication delay [E1145]
- T2 : Spark plug preheat delay [E1157]
- T3 : Maximum starting time[E1135]
- T4 : Delay bewteen 2 start attempts [E1136]
- T5 : Spark plug preheat delay [E1157]
- T6 : Maximum starting time [E1135]
- T7 : Warm up delay [E1139]
- T8 : Speed stabilisation delay [E1140]
- T9 : Voltage stabilisation delay [E1141]
- T10 : Safety on delay [E1514]
- T11 : Normal running
- T12 : Cooling delay [E1142]
- T13 : Engine stop
- T14 : Rest delay after a normal stop [E1144]

Analogue sensors:

The analogue oil pressure and water temperature sensors are used before start-up for the preheat and pre-lube checks: the water temperature [E0030] and oil pressure [E0029] must be ABOVE their respective thresholds (E1155 & E1154) for the engine to be allowed to start.

The default setting for these thresholds is zero. When the thresholds are set at zero, the readings from the analogue sensors are not checked before start-up.

See the chapter concerning Preheat/ Pre-lube/ Plug preheat.

The water temperature [E0030] and oil pressure [E0029] variables can be used in equations.

Failure to start:

In case of insufficient oil pressure or water temperature post start-up, or in case of excess oil pressure or water temperature (digital inputs) during start-up, an "Engine not OK" warning will appear.

Please check your oil pressure and water temperature sensors and their parameters.



WARNING:

The module doesn't take into account an oil pressure fault during the start sequence.

9 PREDEFINED CONFIGURATION

9.1 SINGLE GENERATOR IN CHANGE-OVER MODE

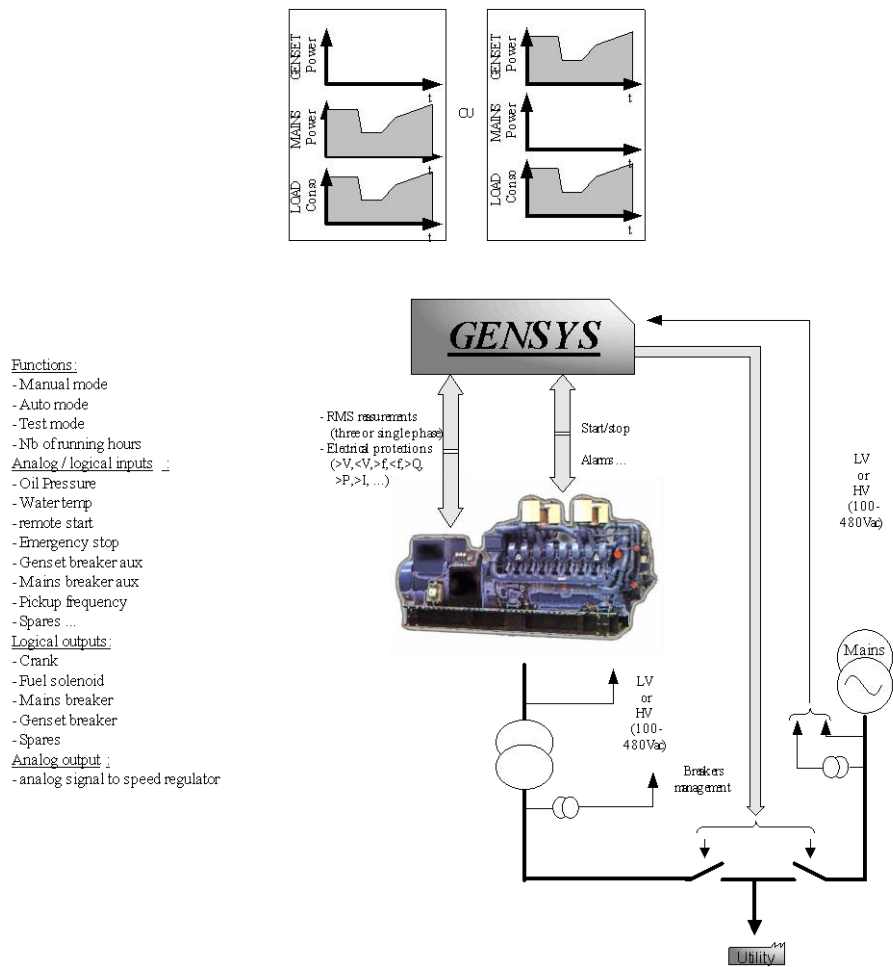

FIGURE 18 - POWER PLANT IN CHANGE-OVER MODE WITHOUT PARALLELING

Variable number	Variable label	Variable value
1179	My Number	1
1147	Nb. of gen.	1
4006	Nb. of Master	0
1148	Mains parallel	Change-over
1153	Mains regul.	X
1158	Load sharing	X
1177	Static paralleling	No
1515	DeadBus manag.	X
1258	Load/Unl. mode	Inhibited
1846	Break Ma Fault	Mains
1841	Fault start	Yes

TABLE 9 - TYPICAL BASIC CHANGE-OVER CONFIGURATION

In Change over mode, as shown in Table 9, the generator starts and takes the load when a mains electrical fault occurs. When mains power returns, the generator breaker is opened and the mains breaker is closed after a pre-set delay.

For the generator to start when mains failure occurs, either a protection (mains or other) or a digital input has to be configured as a "Mains electrical fault". (See Figure 19)

If remote start is on when mains are present the generator starts, GENSYS 2.0 opens the mains breaker, then closes the generator breaker and takes the load. (See Figure 20)

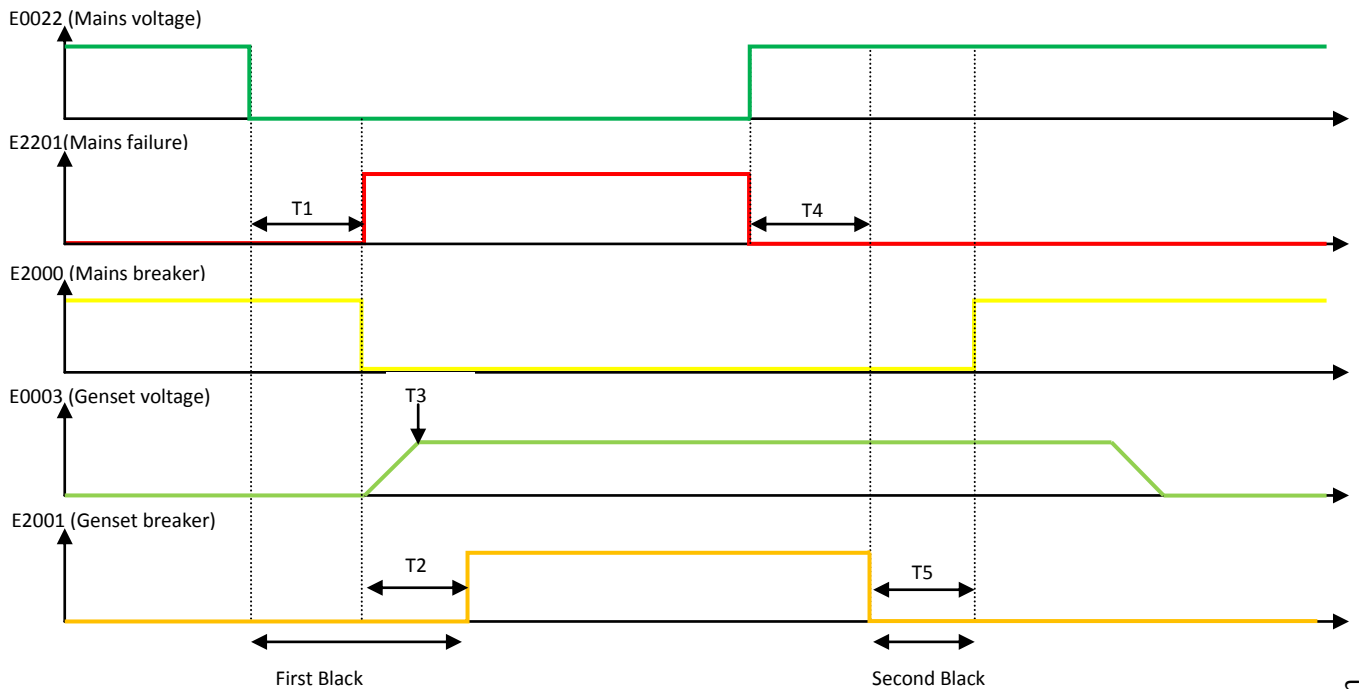

FIGURE 19 - TYPICAL SEQUENCE IN CHANGE-OVER MODE ON MAINS FAILURE

- T1 : Fastest mains failure
- T2 : Switch over delay [E1459]
- T3 : Genset ready
- T4 : Mains back delay [E1085]
- T5 : Switch over delay [E1459]

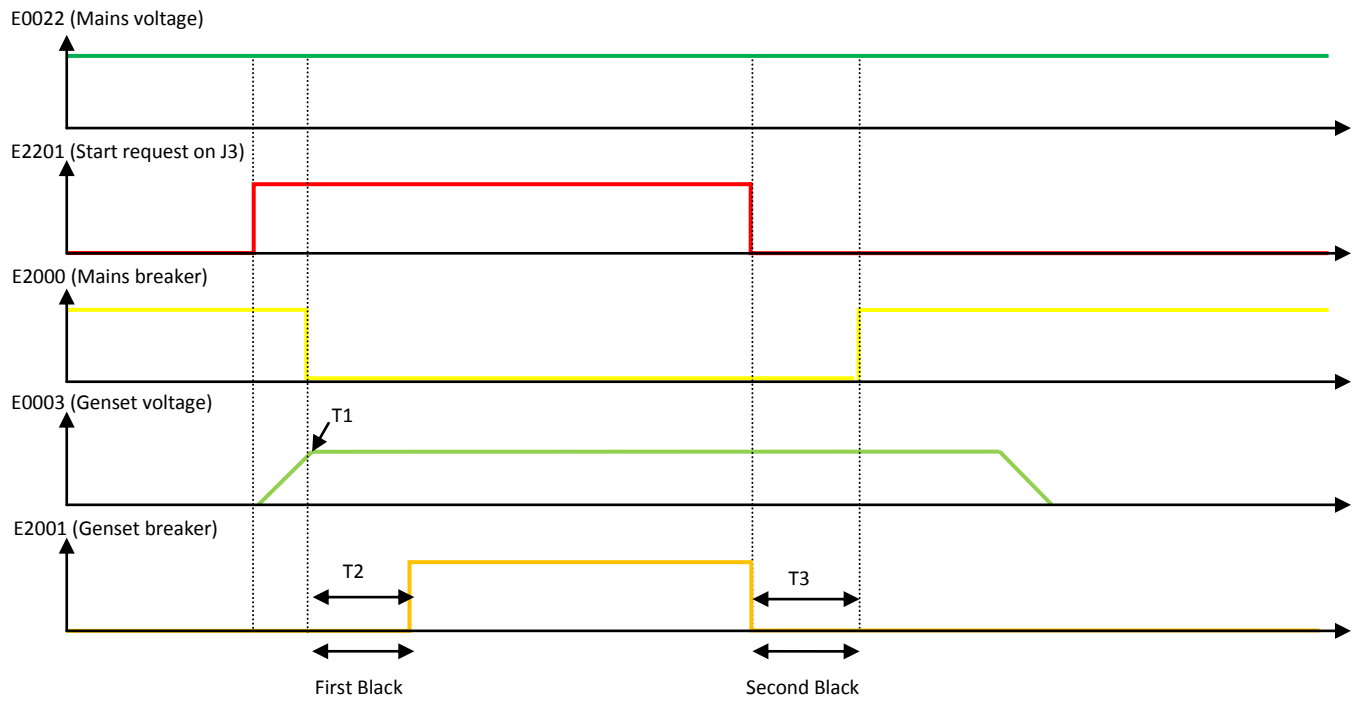

FIGURE 20 - TYPICAL SEQUENCE IN CHANGE-OVER MODE ON START REQUEST

- T1 : Genset ready
- T2 : Switch over delay [E1459]
- T3 : Switch over delay [E1459]

9.2 SINGLE GENERATOR IN NO-CHANGE-OVER MODE

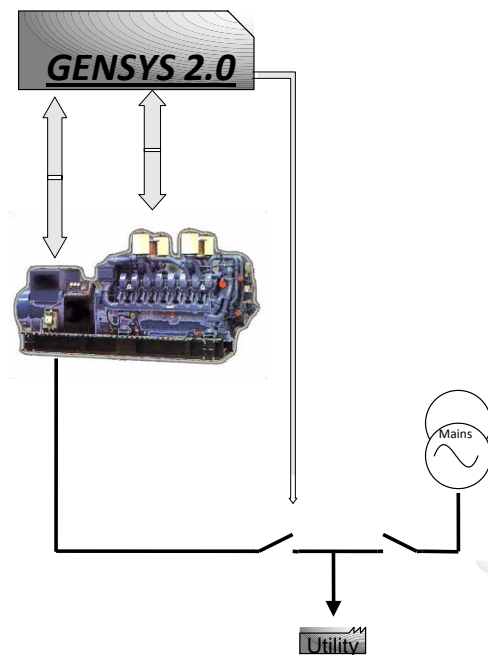

FIGURE 21 - POWER PLANT IN CHANGE-OVER WITHOUT PARALLELING

Variable number	Variable label	Variable value
1179	My Number	1
1147	Nb. of gen.	1
4006	Nb. of Master	0
1148	Mains parallel	NoCh.over
1153	Mains regul.	X
1158	Load sharing	X
1177	Static paralleling	No
1515	DeadBus manag.	X
1258	Load/Unl. mode	Inhibited
1846	Break Ma Fault	Mains
1841	Fault start	Yes

TABLE 10 - TYPICAL NO CHANGE OVER BASIC CONFIGURATION

In "No change over" mode [E1148] GENSYS 2.0 only starts on receiving a remote start signal and doesn't manage the mains breaker.

9.3 GENERATOR PARALLELING WITH DIGITAL BUS

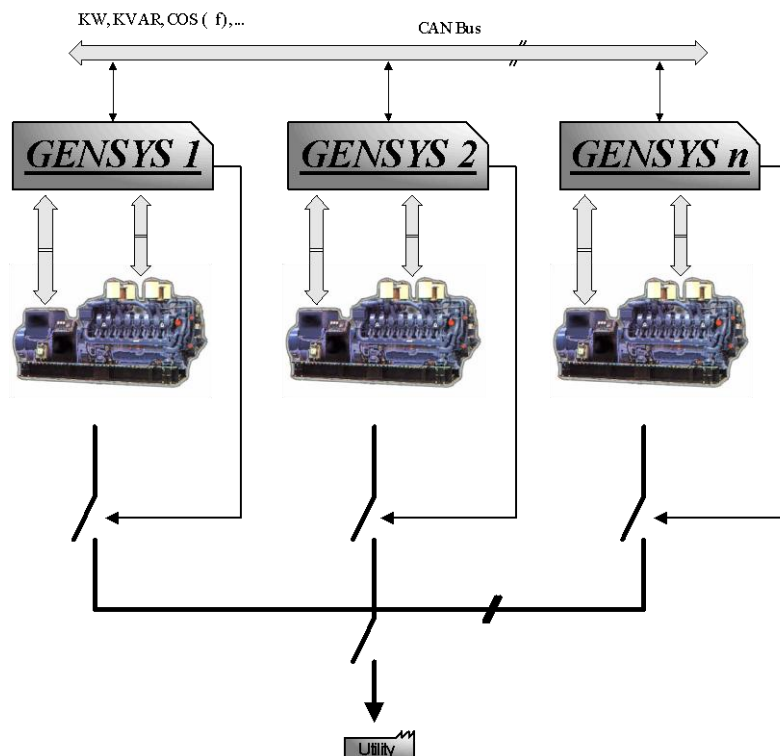

FIGURE 22 - POWER PLANT WITH SEVERAL GENERATORS

Variable number	Variable label	Variable value
1179	My Number	1 to 32 : this value must be different for each device on the same bus
1147	Nb. of gen.	$2 \leq N \leq 32$
4006	Nb. of Master	0
1148	Mains parallel	NoCh.over
1153	Mains regul.	X
1158	Load sharing	CAN bus
1177	Static paralleling	No
1515	DeadBus manag.	Yes
1258	Load/Unl. mode	X

TABLE 11 - TYPICAL BASIC MULTI GENERATOR CONFIGURATION

In this mode, CAN bus on COM1 "inter GENSYS 2.0" is used to manage the different units on the same bus. This mode has better reliability and accuracy than equivalent analogue solutions.

9.4 GENERATORS PARALLELING WITH GENSYS 2.0 AND PARALLEL LINE MODULES

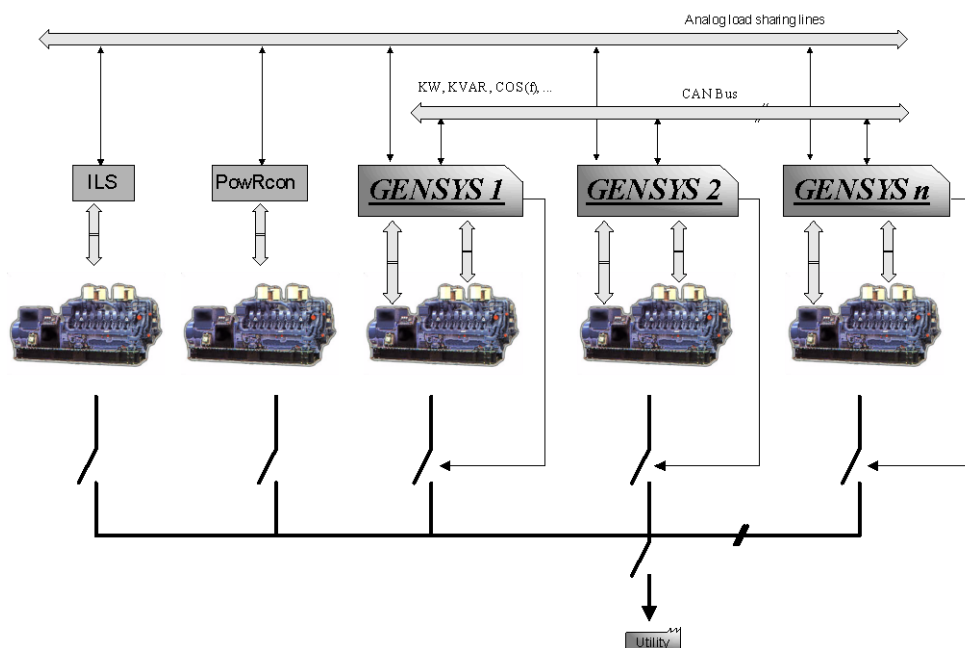

FIGURE 23 - GENERATOR PARALLELING WITH PARALLEL LINES

Variable number	Variable label	Variable value
1179	My Number	1 to 32 : this value must be different for each device on the same bus
1147	Nb. of gen.	$2 \leq N \leq 32$
4006	Nb. of Master	0
1148	Mains parallel	NoCh.over
1153	Mains regul.	X
1158	Load sharing	Analog
1177	Static paralleling	No
1515	DeadBus manag.	No
1258	Load/Unl. mode	Inhibited
1259	CAN bus fault	0 (No action)

TABLE 12 - TYPICAL BASIC CONFIGURATION FOR GENSYS 2.0 WITH PARALLEL LINE MODULES

When GENSYS 2.0 is in analog load sharing mode, the active power sharing is handled via the parallel lines. You have to disconnect the AVR output (H2-H4) and have an external device control the reactive power (CT droop...). This mode is only recommended for use if you have older devices (which are not compatible with CAN inter GENSYS 2.0), with ILS analogue parallel lines.

9.5 MULTIPLE GENERATORS WITH STATIC PARALLELING

This mode is useful when you urgently need to start a full plant with multiple generators. The generators will be ready to take load in the shortest possible time.

This mode is also very useful when your installation includes high voltage transformers. Starting generators which are paralleled together gives a progressive magnetization without peaks (no transient short-circuit).

Note: As long as there is a voltage on the bus bar, the dynamic paralleling mode will be used even if static paralleling is configured. The static paralleling mode is only usable if all of the power generators are stopped and bus bars are dead.

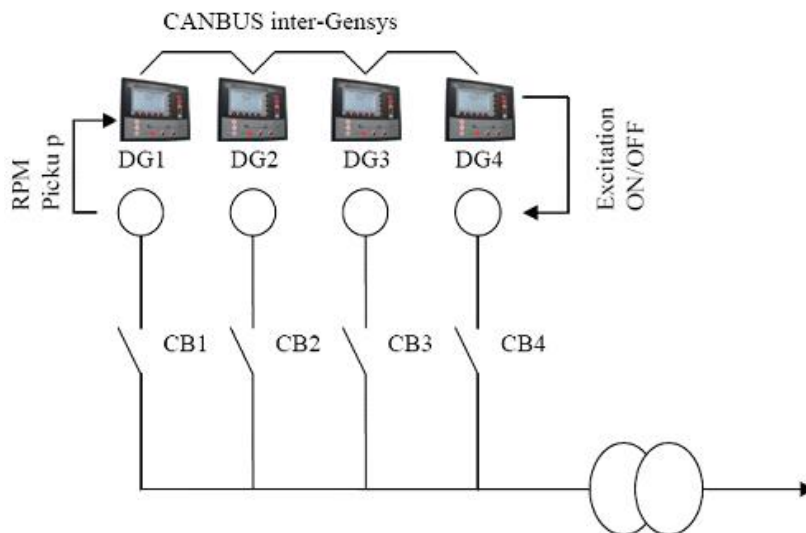

FIGURE 24 - STATIC PARALLELING WITH 4 GENERATORS COUPLED TOGETHER IN EMERGENCY SITUATION

9.5.1 SEQUENCE

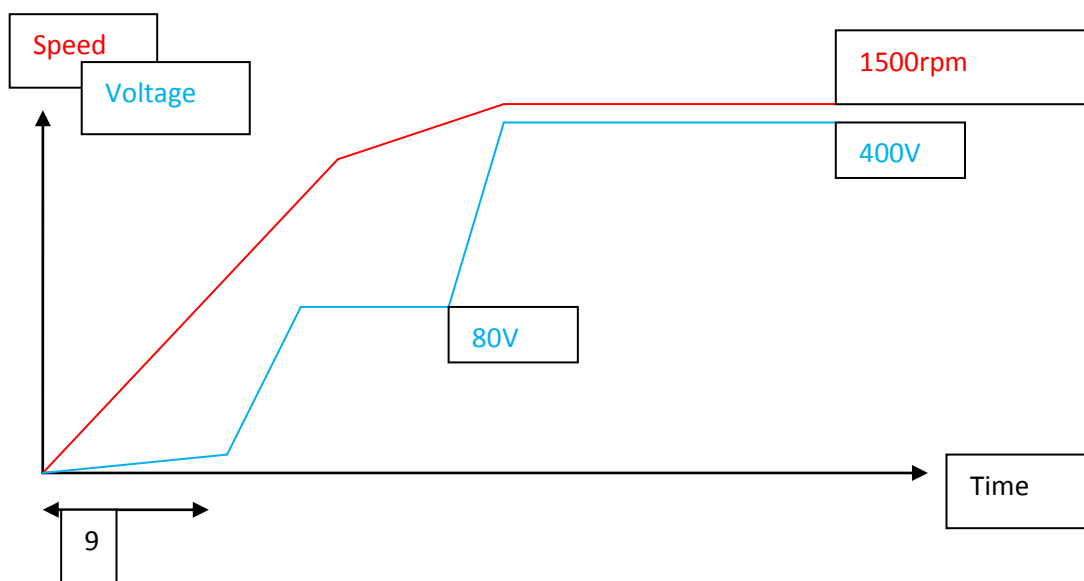

FIGURE 25 - EXAMPLE WITH 4 GENERATORS PARALLELED TOGETHER IN EMERGENCY SITUATION.

- ❖ Loss of voltage
- ❖ Each GENSYS 2.0 is ordered to start.
- ❖ All breakers (CB1, CB2, CB3 & CB4) close as ordered by GENSYS 2.0.
- ❖ DG1, DG2, DG 3, & DG4 start.
- ❖ All generators reach the speed defined by the [E1896] setting (CAN bus synchronization).
- ❖ There is a residual voltage of 80V.
- ❖ All C1 outputs close simultaneously to activate excitation (after dialogue between GENSYS 2.0 units).
- ❖ The nominal voltage is reached immediately at the same time on all generators.
- ❖ The plant is available to take up required load.
- ❖ Breakers are closed when engine is stopped.
- ❖ There is a residual voltage of 80V.

9.5.2 ADVANTAGES

- ❖ Full plant availability in less than 10 seconds.
- ❖ Gradual magnetization of the step-up transformer (no transient short-circuit).

9.5.3 CONFIGURATION

- ❖ One GENSYS 2.0 per generating set.
- ❖ CAN bus must be connected between GENSYS 2.0 units.
- ❖ An "Excitation" output (e.g. exit C1) must be configured on each GENSYS 2.0 unit.
- ❖ Generator breaker must be powered by 24VDC (so as to close without AC).
- ❖ In the Setup menu / General Central / sync mode.[E1177] must be set as "Static stop".
- ❖ The value of the maximum excitation rpm is set with [E1896] (default: 97%).
- ❖ The alternators must be identical.
- ❖ Each GENSYS 2.0 must be equipped with a speed sensor (magnetic sensor / Pick-up).

Variable number	Variable label	Variable value
1179	My Number	1 to 32 : this value must be different for each device on the same bus
1147	Nb. of gen.	$2 \leq N \leq 32$
4006	Nb. of Master	0
1148	Mains parallel	NoCh.over
1153	Mains regul.	X
1158	Load sharing	Bus CAN
1177	Static paralleling	Yes
1515	DeadBus manag.	X
1258	Load/Unl. mode	X
1078	Speed measure	Magnetic

TABLE 13 - PARALLELING WITH MAINS

9.6 SINGLE GENERATOR PARALLELED WITH MAINS

This function needs OPTION 2 to be installed.

9.6.1 CONFIGURATION

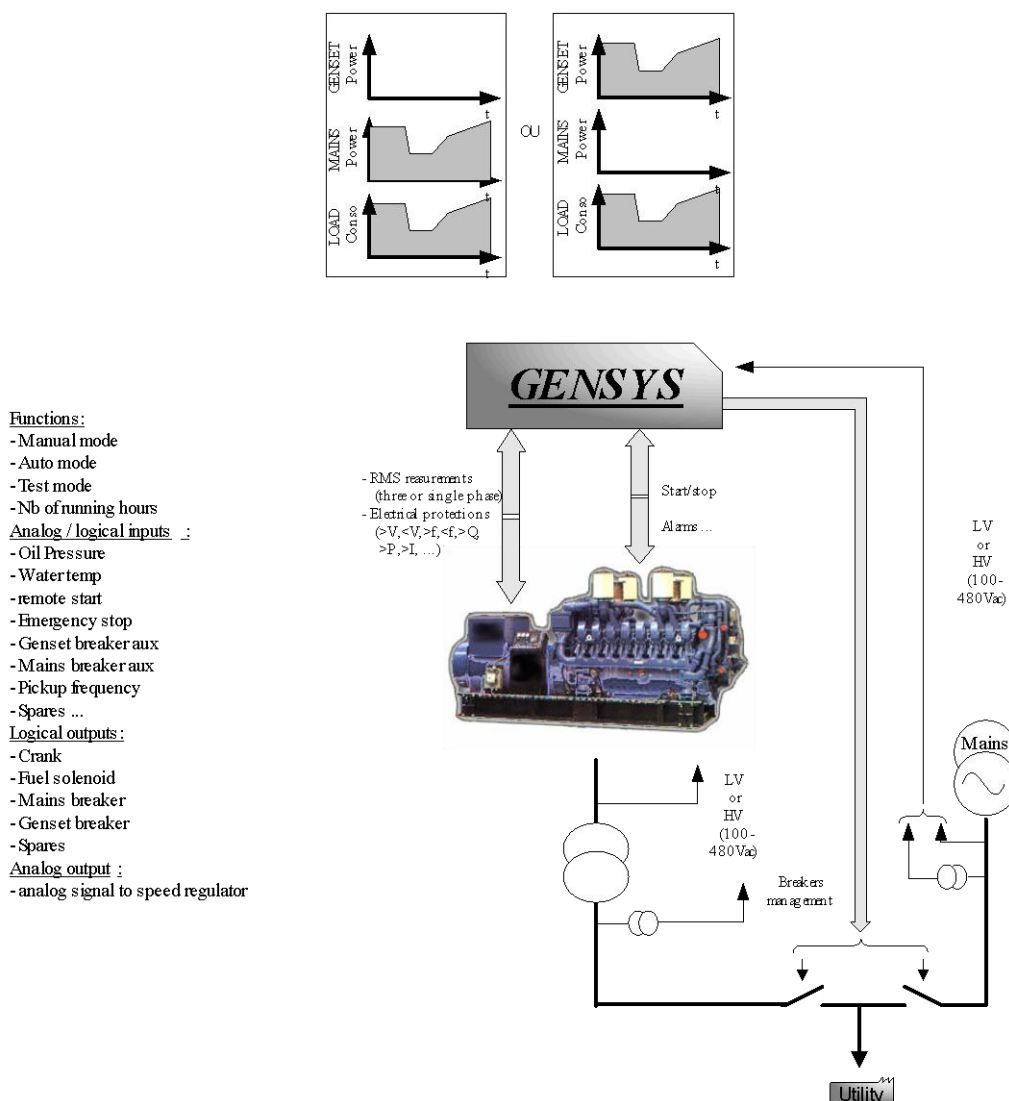

FIGURE 26 - PARALLELING WITH MAINS

In permanent mode [E1148] and peak shaving mode [E1153], a mains power measurement is required:

- internal via L1-L6 inputs (Mains I1, I2, I3),
- or external via G1-G3 inputs (0-20mA).

Variable number	Variable label	Variable value
1179	My Number	1
1147	Nb. of gen.	1
4006	Nb. of Master	0
1148	Mains parallel	NoBreak CO / Permanent
1153	Mains regul.	Base load / Peak shav

Variable number	Variable label	Variable value
1158	Load sharing	CAN bus
1177	Static paralleling	No
1515	DeadBus manag.	X
1258	Load/Unl. mode	Inhibited
1464	Mesure kW	CT or mA(G1-G3)

TABLE 14 - TYPICAL BASIC MAINS PARALLELING CONFIGURATION

In all mains paralleling modes, if a "mains electrical fault" is set (via protections or digital inputs), the generator starts and takes the entire load upon mains loss even if the remote start J3 is off. In all cases, you have to set a mains protection in order to determine the behaviour of your generator when mains power disappears.

9.6.2 MAINS PARALLELING MODE

Choice of mains paralleling mode is configured through parameter [E1148].

1/ No Break CO (No break change over)

When remote start is on, the generator starts, synchronizes and parallels with the mains, then takes the load (ramps up). Once the mains are unloaded, GENSYS 2.0 opens the mains breaker. (See Figure 27)

When remote start is off, the mains takes the load in the same way as the generator did previously. If the generator started for a mains failure, when mains power returns the GENSYS 2.0 synchronizes the load transfer (ramps down), opens the breaker and then stops the generator. (See

)

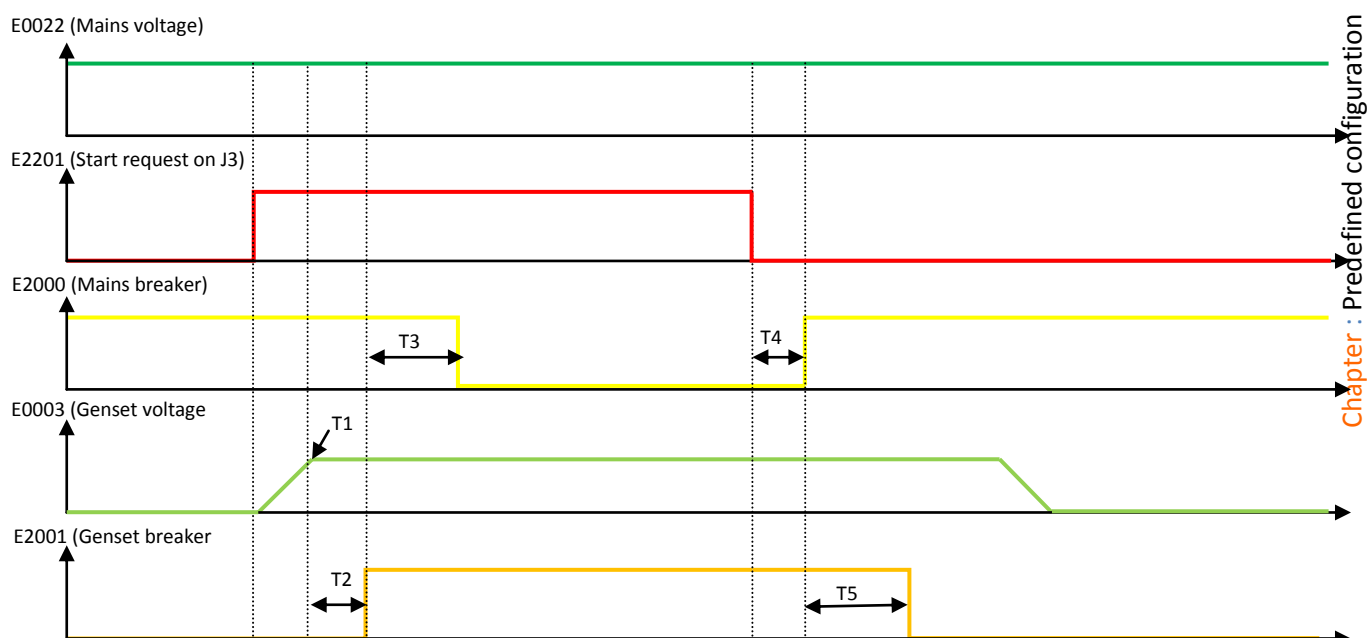

FIGURE 27 - TYPICAL SEQUENCE IN NO BREAK CO MODE ON START REQUEST

- T1 : Genset ready
- T2 : Synchronisation
- T3 : Load ramp
- T4 : Synchronzation
- T5 : Unload ramp

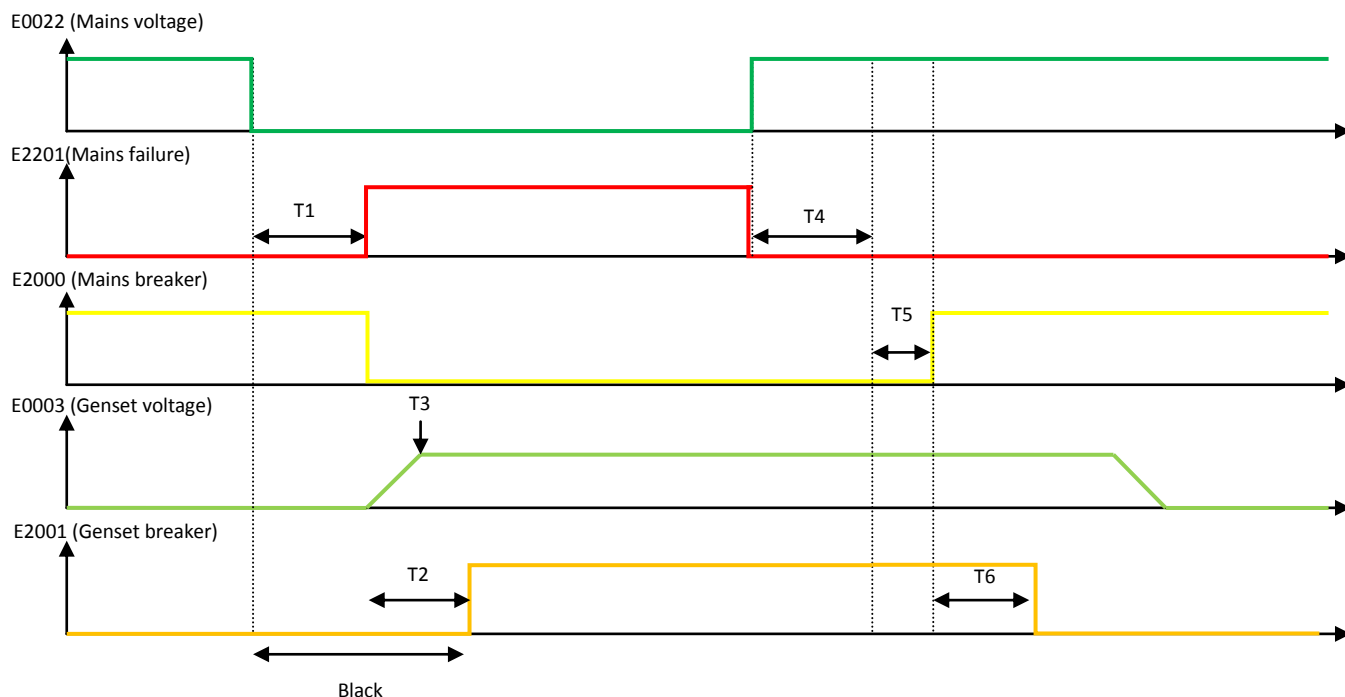

FIGURE 28 - TYPICAL SEQUENCE IN NO BREAK CO MODE ON MAINS FAILURE

- T1 : Fastest mains failure
- T2 : Switch over delay [E1459]
- T3 : Genset ready
- T4 : Mains back delay [E1085]
- T5 : Synchronization
- T6 : Unload ramp

Ramp configurations are available in the “Configuration / Generator” menu. The paralleling time depends on the load, the ramp time and the high and low thresholds.

2/ Permanent mode

WHEN THE REMOTE START IS ON, GENSYS 2.0 STARTS THE GENERATOR, SYNCHRONIZES AND PARALLELS WITH THE MAINS, THEN RAMPS UP LOAD UNTIL IT REACHES ITS SET POINT. (SEE FIGURE 29 &

Figure 30)

In base load mode (E1153=2), the generator has a constant load and the mains take the utility load variations. If the utility load is less than the generator set point, mains are in reverse power.

In the peak shaving mode (E1153=1), the mains have a constant load and the generator takes the utility load variations.

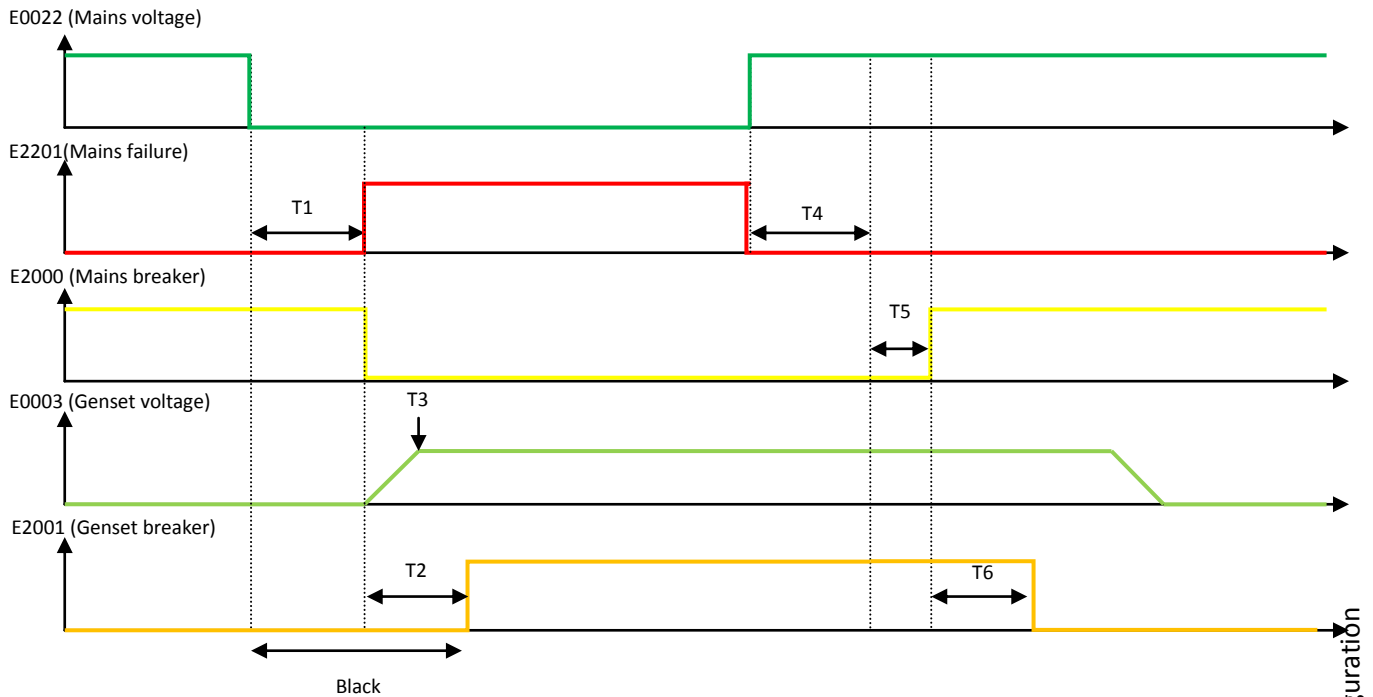

FIGURE 29 - TYPICAL SEQUENCE IN PERMANENT MODE ON MAINS FAILURE

- T1 : Fastest mains failure
- T2 : Switch over delay [E1459]
- T3 : Genset ready
- T4 : Mains back delay [E1085]
- T5 : Synchronization
- T6 : Unload ramp

Note: In this case, the external start request [E2201] is equal to 0.

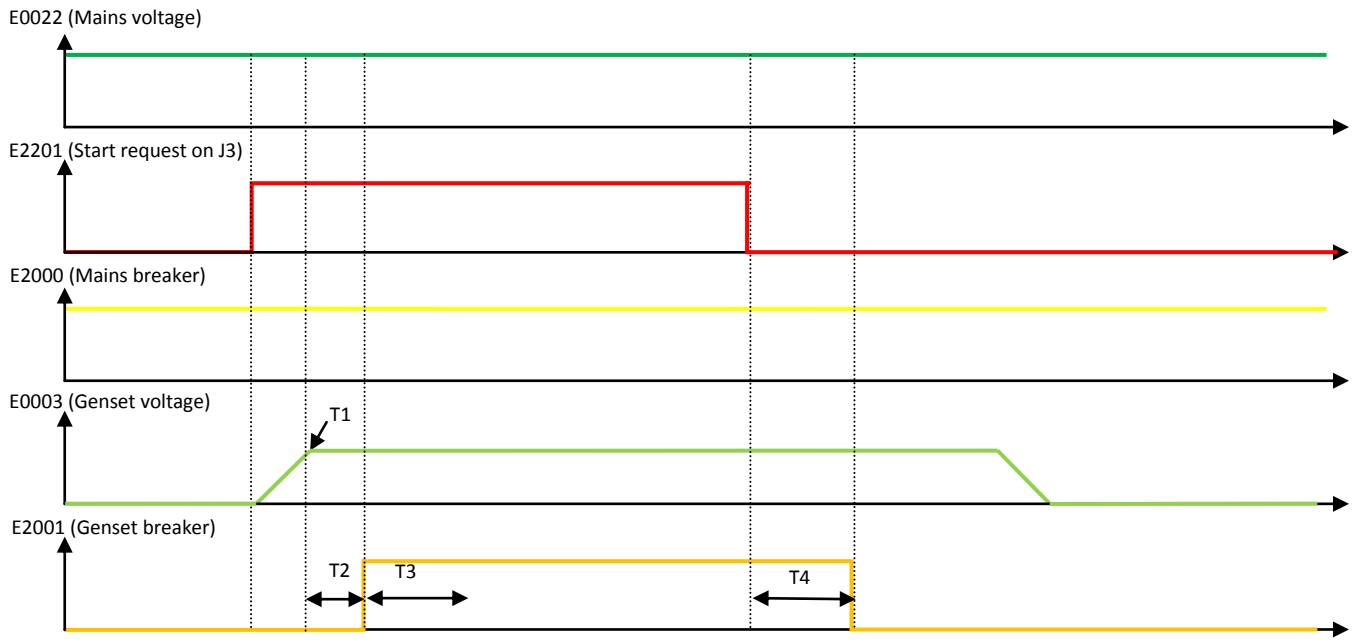

FIGURE 30 - TYPICAL SEQUENCE IN PERMANENT MODE ON START REQUEST

- T1 : Genset ready
- T2 : Synchronization
- T3 : Load ramp
- T4 : Unload ramp

9.7 POWER PLANT PARALLELED WITH MAINS USING MASTER 2.0 OR GCR

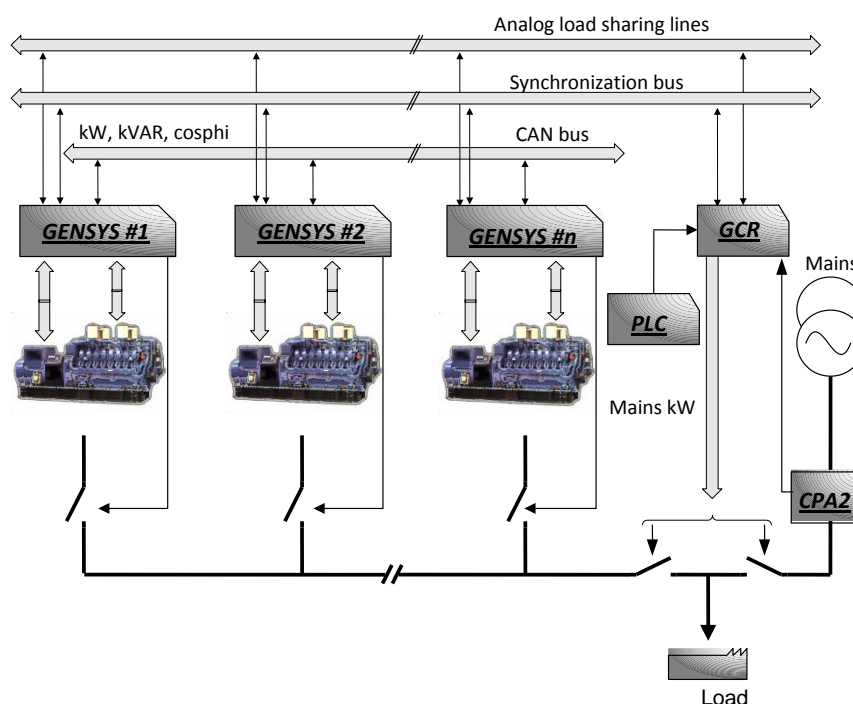

FIGURE 31 - POWER PLANT PARALLELING WITH MAINS

This application requires additional modules to manage the mains power supply. Additional modules can be MASTER 2.0 (recommended) or GCR+CPA (not recommended for a new installation). MASTER 2.0 uses all-digital technology whereas GCR uses analogue load share lines (sometimes called Parallel Lines).

With this setup, base load or peak shaving regulation can be selected, depending on your settings. In base load mode, GCR doesn't require CPA.

This chapter is a basic overview. Full MASTER 2.0 functions can be found in the MASTER 2.0 technical documentation.

Variable number	Variable label	Variable value
1179	Gen. number	1 to 32 : this value must be different for each device on the same bus ⁽¹⁾
1147	Nb of units	$2 \leq N \leq 32$
1148	Mains parallel	No changeover ⁽²⁾
1153	Mains regul	X
1158	Load sharing	Analog (GCR) ou CAN bus (MASTER2.0)
1177	Static parall.	No
1515	Deadbus manag.	Yes
1258	Load/Unl. mode	X

TABLE 15 - PARALLELING WITH MAINS CONFIGURATION

- (1) On the CAN bus point of view, MASTER 2.0 is equivalent to a GENSYS unit, so it must be identified by a number. For example, the use of one MASTER 2.0 gives a maximum of 31 generators.
- (2) Mains paralleling mode is fixed to « No changeover » when a single GENSYS 2.0 is used together with one or more MASTER 2.0.

To allow Power Factor regulation, the "Mains breaker in" (J1) input to GENSYS 2.0 must be connected. Power Factor regulation is not an option.

9.7.1 INTERFACING GENSYS 2.0 WITH GCR

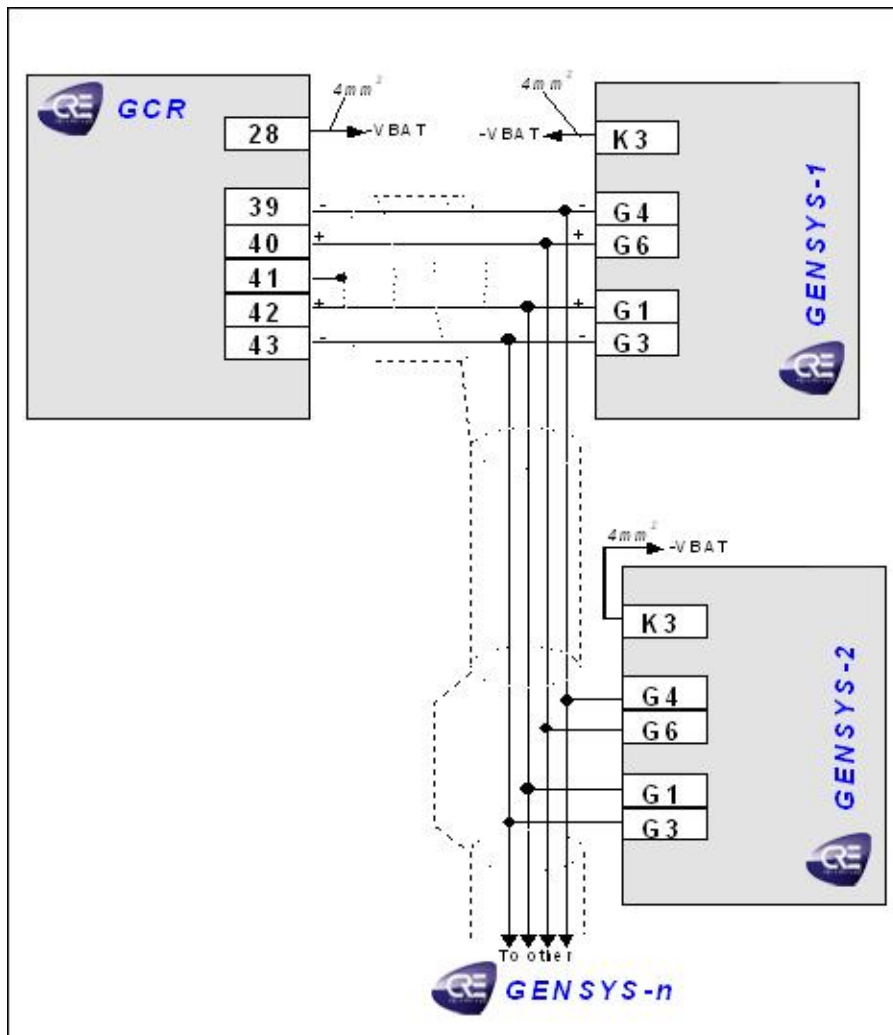

FIGURE 32 - GCR ↔ GENSYS 2.0 WIRING DIAGRAM

- ❖ GCR (39-40) – GENSYS 2.0 (G4-G6): parallel lines (0-3V) to control active power.
- ❖ GCR (42-43) – GENSYS 2.0 (G1-G3): mains synchronization bus (+/- 3V).
- ❖ GENSYS 2.0 (K3): $-V_{BAT}$ from speed governor.

Variable number	Variable label	Variable value
1464	Mains kW Meas.	mA (G1-G3)
1461	Ext kW measure	+/- 10V
1020	20mA setting	20000kW
1021	0kW setting	0mA

TABLE 16 - GENSYS 2.0 / GCR CONFIGURATION

9.8 POWER PLANT PARALLELED WITH SEVERAL MAINS USING A MASTER 2.0 OR GCR PER MAINS

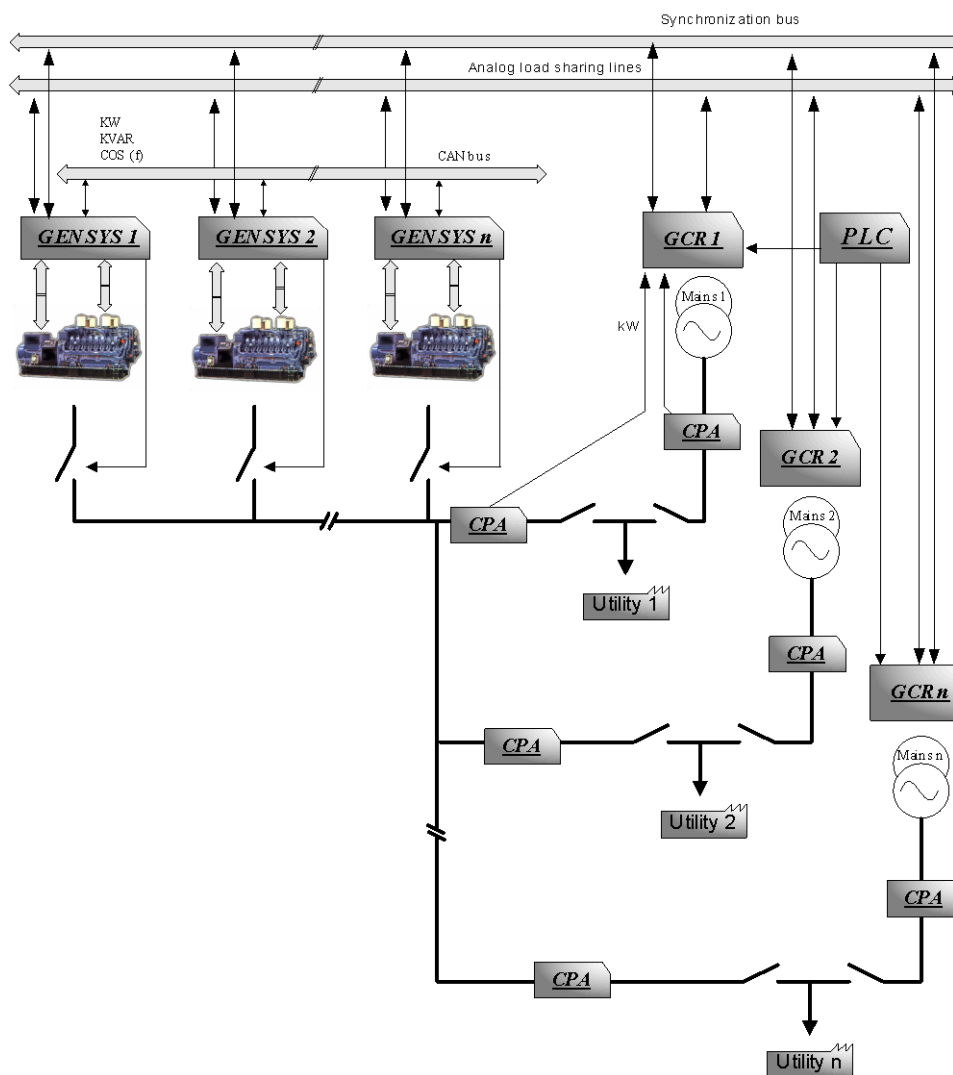

FIGURE 33 - POWER PLANT PARALLELING WITH SEVERAL MAINS

This application requires additional modules to manage the mains power supply. Additional modules can be MASTER 2.0 (recommended) or GCR (not recommended for a new installation). MASTER 2.0 uses all-digital technology whereas GCR uses analogue load share lines (sometimes called Parallel Lines).

This chapter is a basic overview. Full MASTER 2.0 functions can be found in the MASTER 2.0 technical documentation.

Variable number	Variable label	Variable value
1179	Gen. number	1 to n
1147	Nb of gen.	n (>=2)
4006	Nb of Masters	1 to n
1148	Mains parallel	No ch.over
1153	Mains regul.	X
1158	Load sharing	Analog ou CAN bus
1177	Static parall.	No
1515	Deadbus manag.	Yes
1258	Load/Unl. mode	X

TABLE 17 - POWER PLANT PARALLELING WITH SEVERAL MAINS CONFIGURATION

10 INSTALLING AND COMMISSIONING A GENSYS 2.0 APPLICATION

10.1 MINIMUM WIRING DIAGRAM

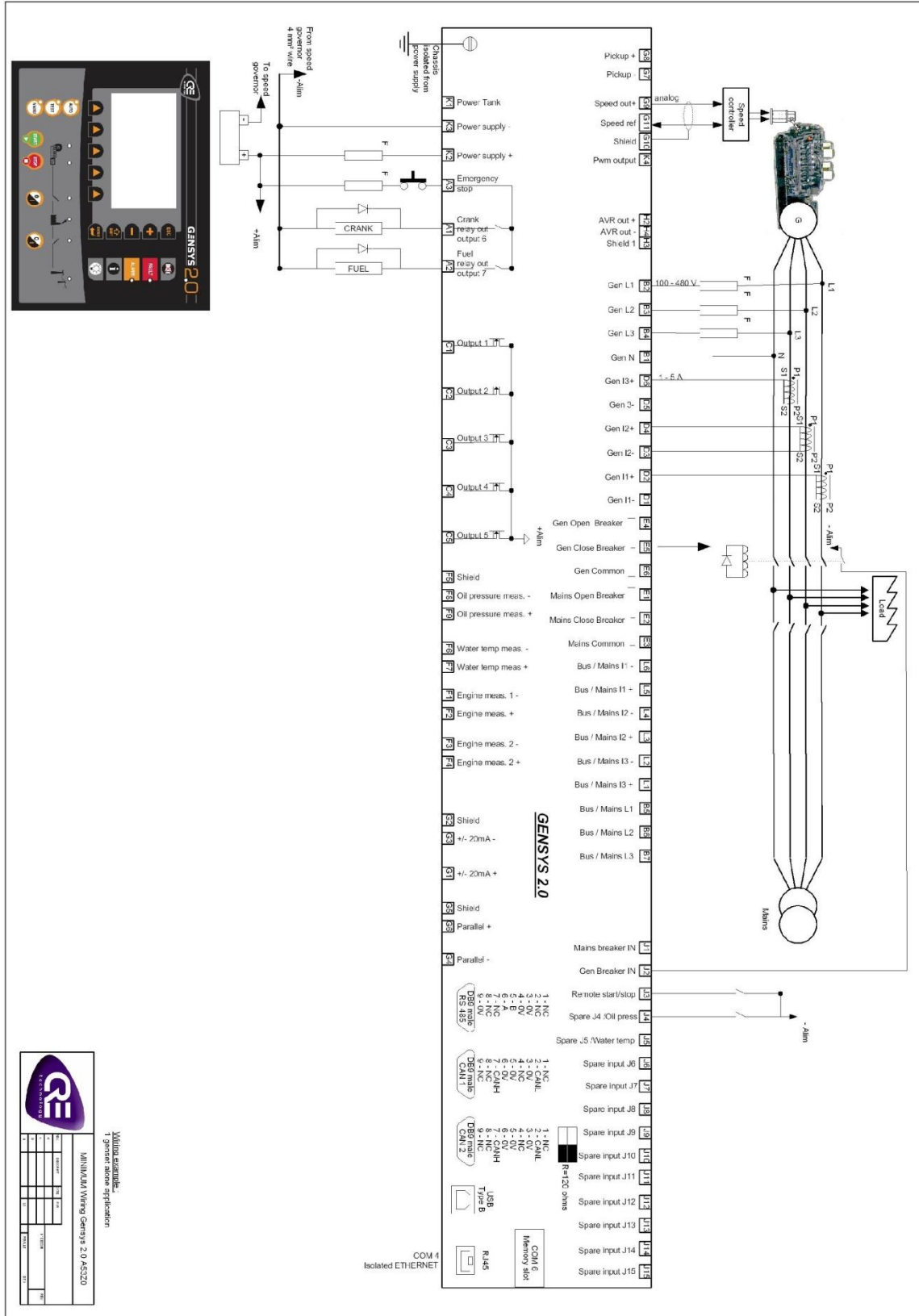

FIGURE 34 - MINIMUM WIRING DIAGRAM

10.2 COMPLETE WIRING DIAGRAM

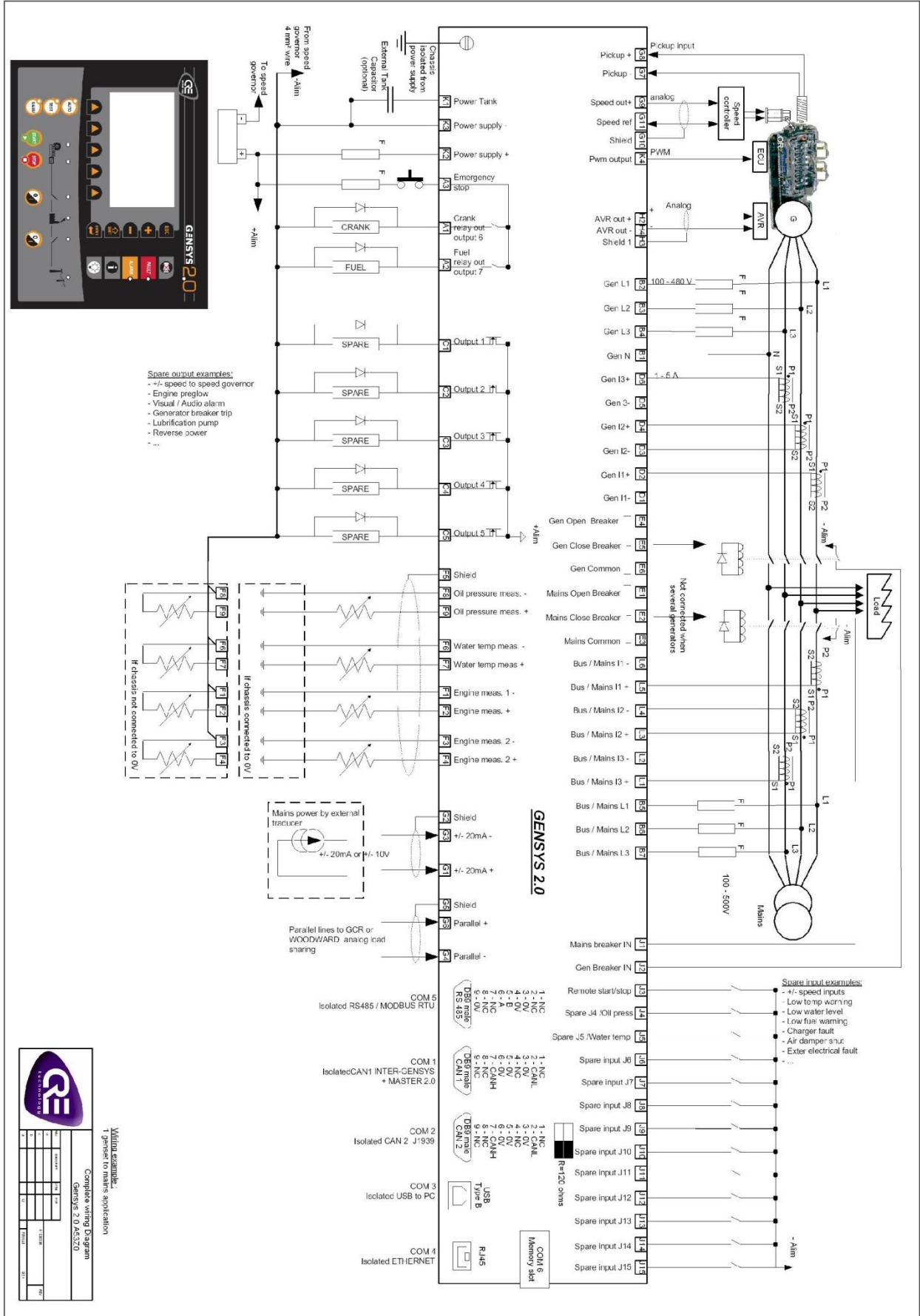

FIGURE 35 - COMPLETE WIRING DIAGRAM

10.3 INSTALLATION INSTRUCTIONS

The GENSYS 2.0 module has been designed for front panel mounting.

Indoor or outdoor installation is possible as long as the following requirements are met:

- ❖ The chosen cabinet must meet the standard safety rules of the workplace.
- ❖ The chosen cabinet must be closed during normal use to prevent the user from coming into contact with power cables.
- ❖ Only the front panel must be accessible during normal use.
- ❖ In accordance with the Bureau VERITAS marine agreement, the module must not be installed in areas which are exposed to the weather.

10.3.1 MOUNTING

To secure the GENSYS 2.0 onto the panel, use the special kit provided with the module. The kit contains 4 screws, 2 brackets and 1 mounting tool.



FIGURE 36 - MOUNTING KIT

Remove the connectors.

Pass the module through the panel cut-out. Ensure that the gasket is properly positioned on the panel and that it is flat.

On the rear side of the module, insert the first bracket into the two holes on the upper edge of the module and push it to the left.

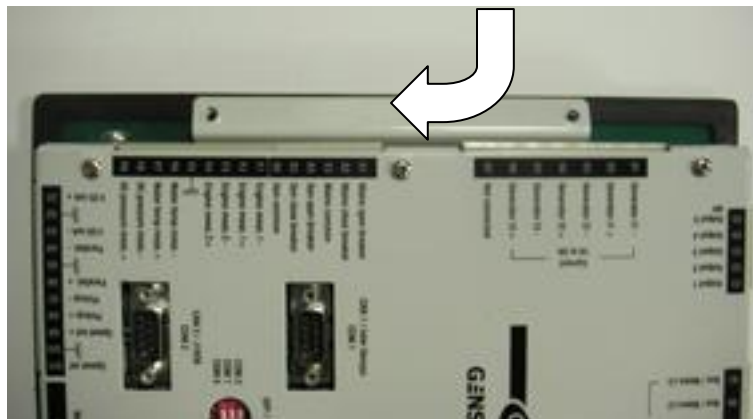

FIGURE 37 - MOUNTING BRACKETS ON GENSYS 2.0

Use the tool which is provided to screw the bracket gently onto the panel (just to hold the module in place).

Insert the second bracket into the two holes on the lower edge of the module and push it to the right.

Use the tool to screw the bracket gently onto the panel.

Tighten brackets gradually until the module is firmly secured.

Plug in the connectors.

10.3.2 EARTH GROUNDING

Earth grounding of the GENSYS 2.0 should be made with two M5 screws & fan washers. Use a short 4mm² cable to connect the unit to earth (see below).

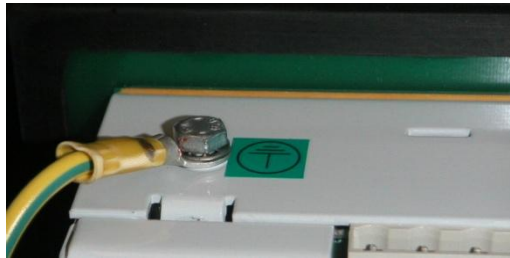

FIGURE 38 - EARTH GROUNDING

10.3.3 WIRING GUIDELINES

The power cable must be kept separate from the communication cable. The communication cable can be installed in the same conduit as the low level DC I/O lines (under 10 volts).

If power and communication cables have to cross, they should do so at right angles.

Correct grounding is essential to minimise noise from electromagnetic interference (EMI) and is a safety measure in electrical installations. To avoid EMI, shield communication and ground cables appropriately.

If several GENSYS 2.0 units are used, each of the 0V power supplies (pin K3) must be connected to each other with a 4mm² cable (use an adapter for the 2.5mm² connection to the GENSYS 2.0 power connector itself).

1/ Power supply circuit breaker

Terminal K3 (0V) should never be disconnected. The battery circuit should only be opened using a breaker placed between the battery's positive terminal and the K2 terminal (Power supply +).

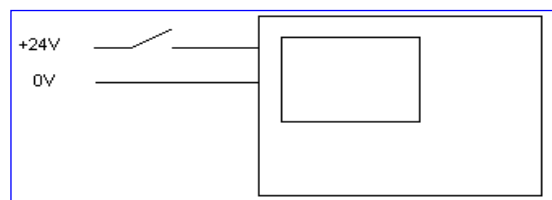
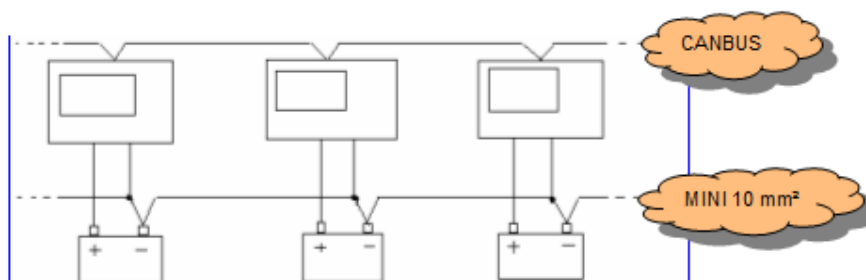

FIGURE 39 - POWER SUPPLY CIRCUIT BREAKER

Note: If terminal K3 (0V) is disconnected and the bus bar voltage is applied to the GENSYS 2.0, there is the risk of getting AC voltage on the CAN bus terminals.

2/ Interconnection of all battery negatives



3/ *Rental fleet & Marine & HV generating sets*

CAN bus isolators are fitted inside the GENSYS 2.0 unit so it is possible to use it safely in MARINE applications and on rental fleets.

4/ *External power tank capacitor*

An external power tank capacitor can be connected between terminal K1 and K3 (See Figure 35) to help the battery maintaining an adequate power supply when starting the engine (low voltage) or brownouts. This capacitor is optional: GENSYS 2.0 is able to operate with a minimum power supply of 9V. This capacitor can be used in case of a **single 12V battery power supply**. Do not connect such power tank on 24V applications.

10.3.4 VIBRATIONS

In case of excessive vibrations, the module must be mounted on suitable anti-vibration mountings.

10.3.5 REAL TIME CLOCK BATTERY

If the battery is disconnected, remove the rear panel and connect a 3V battery to the ST1 jumper (+battery: ST1 up; -battery: ST1 down).

Battery maintenance must be provided separately from the GENSYS 2.0 unit.

10.4 BEFORE COMMISSIONING

10.4.1 SCHEMATICS CHECK

Be sure you have the latest power plant schematics in order to check the presence on site of the wires (CAN bus, shielded wires, Speed governor / GENSYS 2.0 Interface,...)

Be sure that you save your configuration file into an electronics format.

10.4.2 CHECK THE LIST OF INPUTS /OUTPUTS

Check if the required function is present in the list of preset functions in order to evaluate if an input/output needs an extra equation. If case of doubt, contact your local distributor.

10.5 DURING COMMISSIONING

10.5.1 START WITH SAFE CONDITIONS

- ❖ Disconnect the GENSYS 2.0 breaker control connector (labelled as « E »).
- ❖ Check your speed governor settings and your AVR control settings.
- ❖ Check important GENSYS 2.0 parameters (voir §9)
- ❖ Ask the technician who wired the power plant to lock the generator breaker open.
- ❖ Check the fuel input.
- ❖ Check the battery voltage.
- ❖ Check the emergency stop input.

10.5.2 CHECK THE PROTECTIONS

Check the 6 minimum protections before carrying out any other tests:

- ❖ Over speed
- ❖ Over voltage
- ❖ Emergency stop
- ❖ Oil Pressure
- ❖ Water temp
- ❖ Reverse kW

10.5.3 START THE GENERATOR

- ❖ In **[Manu]** mode, press **[Start]** button.
- ❖ Check the starter and fuel pump activation.

If you want to simulate the sequences of starter and fuel switching, disconnect the A1 and A2 terminals, then navigate to the menu "Display/ Inputs/outputs state / Relay outputs" , the states of A1 and A2 will be displayed in real time.

- ❖ When the engine has been started, check the engine speed and the generator voltage.

They must be stable and to the desire value (ex: 1500rpm, 50Hz, 400VAC), these information are available in the menu "Display/ Generator electrical meter/ Global view Generator"

- ❖ Press **[Stop]** button to stop generator.

10.5.4 CHECK THE CONTROL OF THE DEAD BUS BREAKER

- ❖ Start the generator in **[Manu]** mode by pressing **[Start]** button.
- ❖ Press the generator breaker **[0/I]** key.
- ❖ The breaker should close (control OK) and the GENSYS 2.0 front face led should light up (feedback position OK).
- ❖ Press the generator breaker **[0/I]** Key.
- ❖ The breaker should open and the led should go out.

10.5.5 CHECK OR IMPROVE SYNCHRONIZATION

- ❖ Check that breaker control is disabled (Unplug connector “E”).
- ❖ Check voltage on bus bar.
- ❖ Start the generator in **[Manu]** mode by pressing **[Start]** button.
- ❖ Press the generator breaker **[0/I]** key.
- ❖ Check that you are now in synchronization mode using the information screen key **[i]**.
- ❖ When the GENSYS 2.0 is ready to synchronize (synchroscope to noon), check the phase sequence and check that the phases match in upstream and downstream of the breaker. (i.e. low voltage difference between phase n°1 generator and phase n° 1 bus, and so on for the other phases). If one of these checks is not correct, you have to check the wiring of the generator voltage and mains voltage.
- ❖ When you are sure there is no wiring problem, stop the generator by pressing **[Stop]** button.
- ❖ Activate the breaker control. (Plug connector « E »).
- ❖ Start the generator in **[Manu]** mode by pressing **[Start]** button.
- ❖ Press the generator breaker **[0/I]** key.
- ❖ The generator must be paralleled without difficulties.

Note: If the generator sweep around the synchronization point or if the synchronization is too slow, adjust the synchronization gain in the menu « Configuration/Synchronization/Phase synchro »

Method to set the synchronization PID:

If the point oscillates quickly around the top synchro: decrease the gain

If the point oscillates slowly around the top synchro and is hard to stabilize: decrease the integral

If the point rotates slowly or quickly: increase the integral, then the gain if necessary.

10.5.6 CHECK OR IMPROVE LOAD SHARING / KW REGULATION

For this application, check the stability of kW and kVAR regulation.

After the mains breaker closes, check load ramp (P=CsteGPID) configuration in the “Active Power Regulation” menu.

If the genset goes into reverse power or stays at low load during the ramp time (E1151) increase P=CsteGain in the “Active Power Regulation” menu.

At the end of the ramp time, the GENSYS 2.0 will swap to “kW Sharing Gain”.

You can now set your load sharing gain and check the settings which depend on load impact (test with load bench, for example).

- ❖
- ❖
- ❖ For this point, it's important to check the wiring of the power lines (current transformer ...)
- ❖ After paralleling, the GENSYS 2.0 start a power regulation according to his configuration :
 - Load sharing if paralleling between generators
 - Constant kW setpoint on generator if GENSYS 2.0 is set as Permanent with base load
 - Constant kW setpoint on mains if GENSYS 2.0 is set as Permanent with Peak shaving
 - Droop

- ❖ Whatever the power regulation, it's important to have power on bus in order to check the currents/voltages/ $\cos(\varphi)$ measurements.
- ❖ The menu « Display/Generator electrical meter/Global view generator » will allow to check that the consumed power by phase is positive and balanced. If it's not the case, check your wiring.



WARNING:

A wrong wiring affecting the power measurements (e.g. reverse of current terminals) will cause a bad GENSYS 2.0 control that can result in an overload or a reverse kW.

- ❖ When the power measurement has been check ; the load sharing or constant kW setpoint can be adjusted by this way :
 - For a GENSYS 2.0 in load sharing :
 - In the « Configuration/Control loops/kW control/kW sharing loop » menu, you can adjust the gain in order to improve the load balanced between GENSYS 2.0 (Adjustment between 0 and 200%)
 - For a GENSYS 2.0 in kW setpoint (base load or peak shaving), or in load ramp:
 - In the « Configuration/Control loops/kW control/Ramp/Constant kW » menu, you can adjust the gain in order to improve the load ramp, or the integral in order to improve the constant kW setpoint Adjustment between 0 and 200%)

11 DEDICATED I/O LINES

Inputs/outputs are associated with functions. Some I/Os are dedicated; others are programmable using configuration parameters.

11.1 SPEED GOVERNOR INTERFACE

This interface is used to control engine speed.

The Speed governor control is used to manage Speed set points, Synchronization, kW Load sharing and kW set points.

The Speed governor interface can be:

- ❖ Analogue output
- ❖ PWM 500Hz digital output (CATERPILLAR/PERKINS)
- ❖ Digital pulse output (see §11.2)

11.1.1 ANALOGUE SPEED GOVERNOR OUTPUT

The following procedure must be used to match the interface with the speed governor:

- ❖ Connect the speed ref. wire only (G11).
- ❖ Check that the negative speed governor power supply is shared with those of the GENSYS 2.0.
- ❖ Go to menu “Configuration/Engine/Speed control settings/Speed governor settings”
- ❖ Set the gain [E1076] and offset [E1077] as described in the Table 18 below (if not in the list, contact CRE Technology).
- ❖ Start the generator at 1500 RPM in **[Manu]** mode by pressing **[Start]** button
- ❖ Measure the voltage on the speed governor terminal and adjust offset [E1077] on GENSYS 2.0 in order to get the same voltage on G9-G11 terminals.
- ❖ Connect the speed control Speed out + (G9), and refine the nominal frequency by adjusting the offset [E1077].
- ❖ Check the speed variation range by pressing [+] and [-] button in [Manu] mode. The speed variation range must not exceed +/-3Hz and must not be lower than +/-2Hz. The best settings are reached when the GENSYS 2.0 is able to control the frequency with +/-2,5Hz around the nominal frequency.
- ❖ If the speed variation range is too wide or too narrow, adjust the gain [E1076]

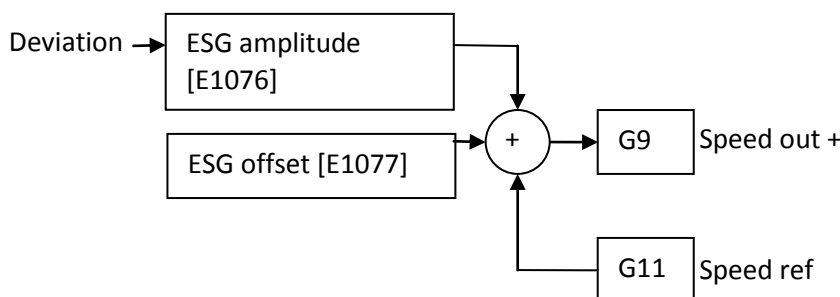

FIGURE 41 - SPEED OUTPUT

The ESG offset adjustment [E1077] can be set between -100 and +100 (-10VDC to + 10VDC), and is added to the external speed reference (G11).

Notes :

The Speed ref (G11) doesn't need to be connected if there is no voltage reference available.

0V must be wired with 4 mm² cable as follows: battery ⇒ speed governor ⇒ GENSYS 2.0.

See table below for presets. For specific settings contact your dealer.

Manufacturer	Model	ESG Amplitude (1076)	ESG offset (1077)	Terminal G9 (out)	Terminal G11 (ref)	Remark
HEINZMANN	E6	10%	0%	B3		
	KG6 / System E6	-25.00%	46.50%	E3	NC	
	PANDAROS DC6	24%	26%	B3	A3	Voltage converter to isolate the signal on the line. (DC/DC) (advise)
CUMMINS	ECM pour QSK23 / QSK40 / QSK45 / QSX15 / QSK 60	1.00%	00.00%	10 (Barber Colman Frequency bias input)	06 (5Volts)	
	EFC	2%	0%	8	9	See Figure 42 – Connection with EFC Cummins
	ECM (QST30)	1.00%	-3.00%	18	15(7,75v)	
BARBER COLMAN	All models with analog input	5%	-1.65%	ILS input	4v	
	DPG 2201	10%	-1.05%	ILS signal	2,5V	
		1.6%	-27%	ILS signal	Digital supply (+5V)	
		1.6%	25%	ILS signal	BAT-	

Manufacturer	Model	ESG Amplitude (1076)	ESG offset (1077)	Terminal G9 (out)	Terminal G11 (ref)	Remark
WOODWARD	- 2301A/D ILS+speed	25.00%	25.00%	10	11	Shunt 14-16
	- (Without U&I)	90.00%	0%	25	26	Shunt 26 (com) on 0V
	2301D	25.00%	00.00%	15	16	G11 connected to 0v
	2301A Speed only	99.00%	-1.00%	15	16	16 connected to 0V
	Pro-act / Pro-act II	25.00%	00.00%	Aux +	Aux -	Aux- connected to 0V
	EPG System (P/N : 8290-189 / 8290-184)	25.00%	30.00%	11	NC	11-12 open
MTU	MDEC	50.00%	00.00%	8	31 (5v)	Programmable
VOLVO	EDC 4	15.00%	- 25.50%	24 / conn. F	25 / conn. F	
	EDC III	20.00%	25,00%	Pot signal	NC	
PERKINS	ECM	25.00%	- 25.00%	30	3 (5v)	
DEUTZ	EMR	8.00% to 13.50%	- 26.20%	24	25	+/- 1.5 Hz not to reach EMR over-speed
	TEM compact	--	--	--	--	See §14.9
GAC	All ESD (except ESD5330)	-20%	-63.8%	N	P	
	ESD5330	-17%	+40%	M	G	
Ghana Control	PWC 2000	75.5%	-25%	J	G	
SCANIA	16 ltr full electronic engine	20%	-36%	54	28	

Manufacturer	Model	ESG Amplitude (1076)	ESG offset (1077)	Terminal G9 (out)	Terminal G11 (ref)	Remark
CATERPILLAR	EMCP11 interface	5%	- 13.10%	2	1	-2Hz and +0,8Hz (although the GENSYS 2.0 output still increase)
JOHN DEERE LEVEL III	ECU	38%	23.80%	G2(speed input line) 915	D2(sensor return)914	Two different wirings for the same governor.
		34%	-15%	G2	5V(ref speed) 999	

TABLE 18 - SPEED GOVERNOR PARAMETERS

Connecting GENSYS 2.0 to a Cummins EFC:

Because of the very high sensitivity of Cummins EFC module input, please use the schematic below to connect your GENSYS 2.0 to the EFC. The resistors must be as close as possible of the speed governor terminal. This way, GENSYS 2.0 analogue speed output can be set higher (parameter E1076) according to the resistors used.

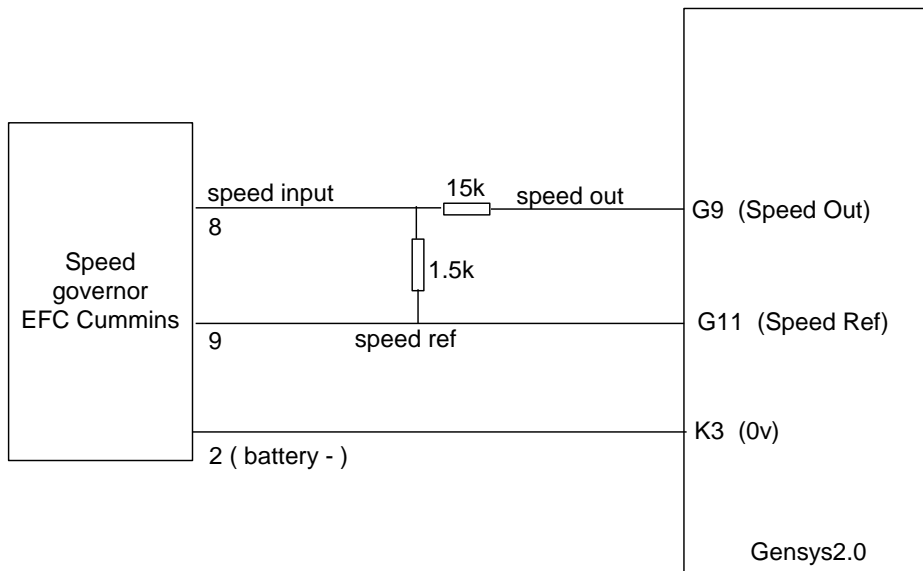

FIGURE 42 - CONNECTION WITH EFC CUMMINS

11.1.2 PWM 500 HZ (CATERPILLAR/PERKINS)

K4 output is a 500Hz PWM output signal between 0 and 5V. It is protected against short-circuits between the output and the battery negative voltage. To activate this PWM output in order to control speed of Caterpillar or Perkins engines, please check GENSYS 2.0 parameters as shown below.

Variable number	Label	Value	Description
E1639	500 Hz ACT	1	Activates the speed control with 500Hz PWM. In this mode the analogue speed output (G9 / G11) is unavailable.
E1077	ESG offset	70%	Is the PWM duty cycle set for nominal frequency.
E1076	ESG amplitude	30%	Is the range of the PWM duty cycle to control engine speed. For example, if you have set 20.0%, the PWM will vary +/- 10% around the nominal duty cycle value.

TABLE 19 - PWM PARAMETERS

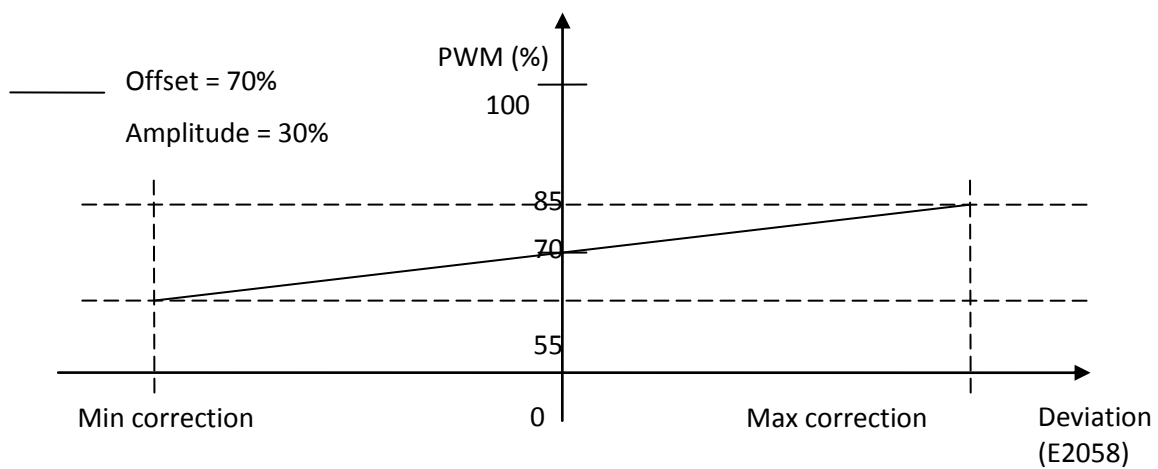

FIGURE 43 - PWM DYNAMIC



On firmware versions before v4.55, offset and amplitude values were inverted compared to CATERPILLAR usage. I.e. offset E1077 had to be set to 30% in order to get a 70% PWM on the physical output. Also, amplitude E1076 had to be set to a negative value (for example -30%) in order to get a proper control (higher speed when GENSYS 2.0 requested a positive correction).



Starting from v4.55, offset and amplitude values are working the same way as in CATERPILLAR usage.

If you send a TXT file from an old firmware (i.e. from v1.00 to v4.04) into a newer unit (with firmware v4.55 or later), parameters will be automatically adapted and you will be informed by the compilation result :

WARNING 001: PWM 500Hz settings updated (E1076, E1077). See technical documentation.

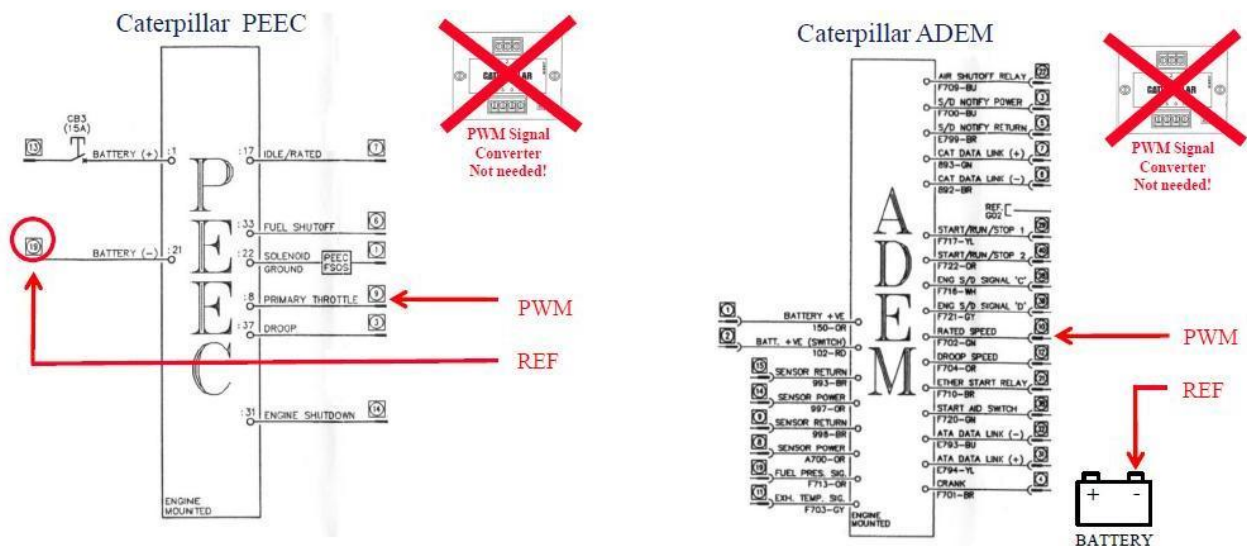

FIGURE 44 - CATERPILLAR PEEC AND ADEM CONNECTIONS

11.2 SPEED AND VOLTAGE CONTROL WITH CONTACTS/PULSES

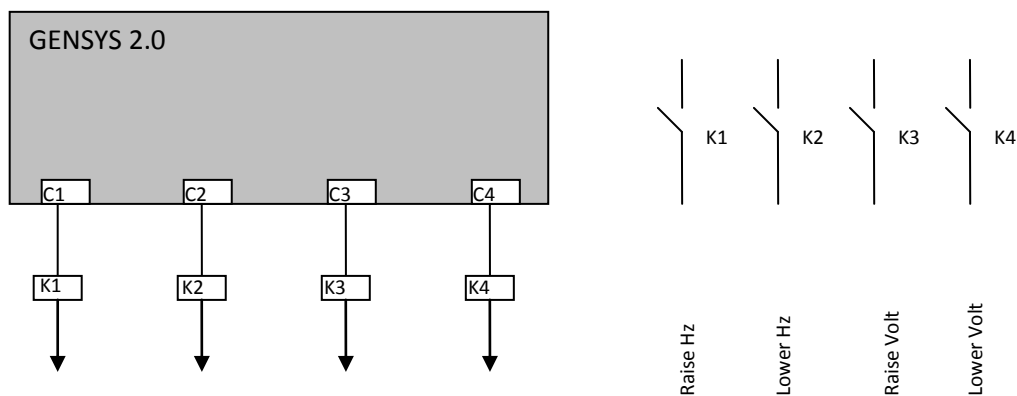

FIGURE 45 - SPEED AND VOLTAGE CONTROL WITH CONTACTS / PULSES

11.2.1 PARAMETERS

Paramètre	Valeur	Description	Menu
E1260	+f [E2341]	Output C 1	Configuration/Outputs/Digital outputs
E1261	-f [E2342]	Output C2	Configuration/Outputs/Digital outputs
E1262	+U [2343]	Output C3	Configuration/Outputs/Digital outputs
E1263	-U [2344]	Output C4	Configuration/Outputs/Digital outputs

TABLE 20 - PARAMETERS SPEED AND VOLTAGE CONTROL WITH CONTACTS / PULSES

11.2.2 SPEED CALIBRATION PROCEDURE

Here follows the procedure for calibrating the +Hz and -Hz outputs on the GENSYS 2.0, necessary in order to have good frequency droop compensation and load sharing. (See Figure 46)

- ❖ Show the following parameter on the information screen: [E2058].
- ❖ Place the external speed potentiometer in the centre mid position.
- ❖ Set the following parameters as follows:
 - [E1598] on "50" which is about 1 percent load sharing difference (dead band on E2058)

- [E1600] on "2" which is 200 msec. Pulse time
- [E1874] on 2.0 sec. which is pulse pause time for frequency/voltage compensation
- [E1873] on 0.1 sec. which is pulse length for frequency/voltage compensation.
- [E1309] on 0 which is Integral gain (I) phase
- [E1113] on 0 which is Integral gain (I) Frequency.

Note: For best results during synchronization, it's important to set the synchronization GPID to high values (80 to 20).

1/ Regulation setting (synchronization/load ramp)

If the generator makes too much or not enough correction during an active phase (synchronization, load sharing,...), the pulse time is bad adjusted:

- Decrease [E1600] to reduce the pulse control on the governor
- Increase [E1600] to have more correction on the governor.

If the generator oscillates around the setpoint during an active phase or if it's hard to reach the setpoint, it means that the dead band [E1598] is bad adjusted:

- Decrease dead band [E1598] to improve the accuracy around the setpoint.
- Increase dead band [E1598] if the generator oscillates in frequency or in load.

If the generator takes too much time to reach the nominal speed during the regulation, it means that period [E1874] is too long.

If you don't get the desired compensation, check the following points:

- Is the potentiometer still running when GENSYS 2.0 send an output signal?
- Otherwise, the potentiometer doesn't control a wide enough speed range.

Note: If a pulse generates an over-compensation, the motor potentiometer still running even if there is no pulse. A shunt resistor on the motor input can correct this problem.

2/ Frequency center settings

If the generator changes his speed but compensated too much or not enough to reach the nominal speed, the pulse [E1873] is bad adjusted:

- Decrease [E1873] to reduce the center frequency control
- Increase [E1600] to increase the center frequency control

Note : If an automatic center frequency control exist, (e.g. isochronous mode), the parameter [E1873] can be set to 0.

11.2.3 VOLTAGE CALIBRATION PROCEDURE

Here follows the procedure for calibrating the +U and -U outputs on the GENSYS 2.0. The same procedure than the speed calibration procedure (see §11.2.2) has to be followed to calibrate the voltage control. (See Figure 46)

[E1599] No action range for +U/-U (in %), default value = 50

[E1601] Impulsion delay for +U/-U, default value = 2 (200ms)

[E1874] Set to 2 sec which is the pulse pause time for frequency/voltage compensation. This parameter was adjusted for speed control, so do not modify.

[E1873] Set to 0.1 sec which is the pulse length for frequency/voltage compensation. This parameter was adjusted for speed control, so do not modify.

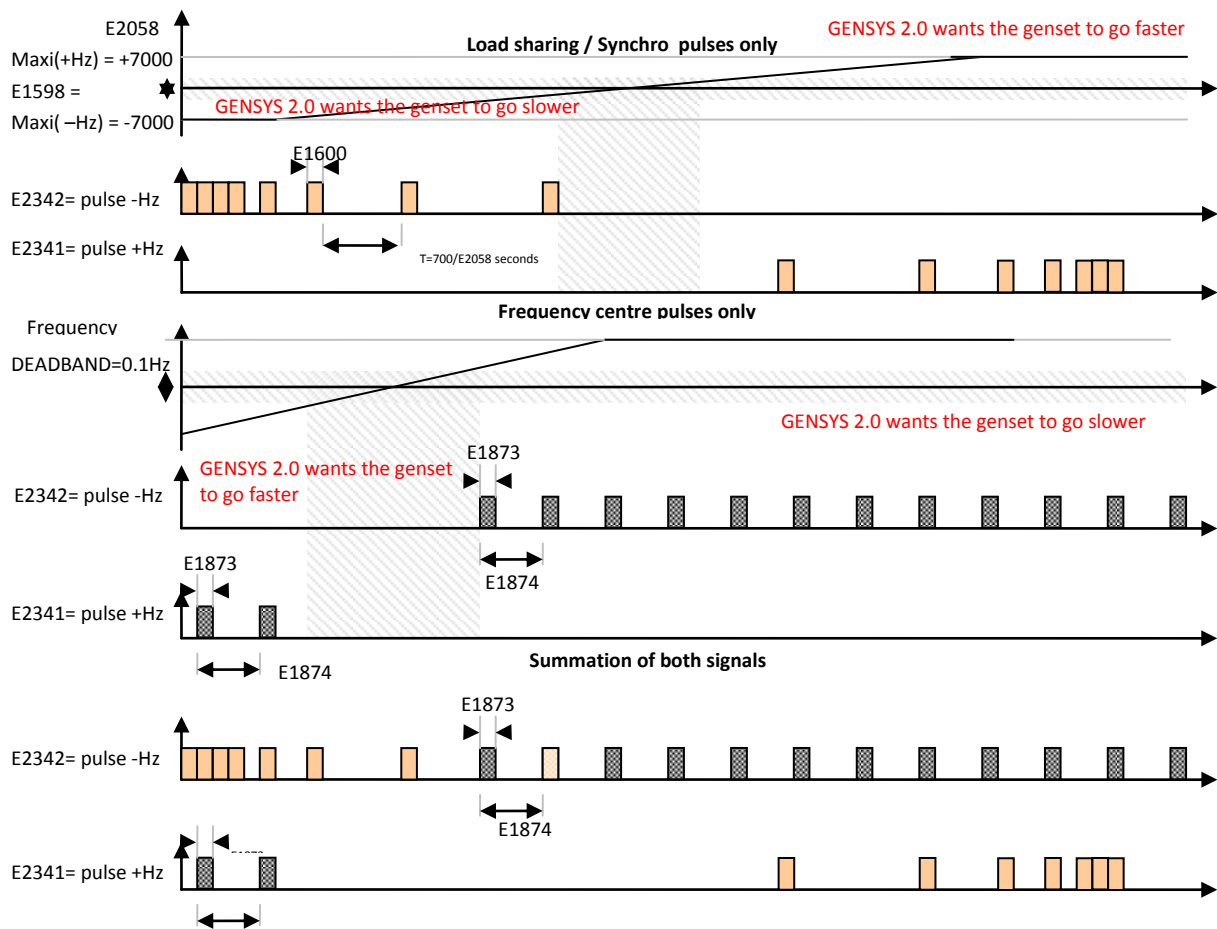

FIGURE 46 - SPEED AND VOLTAGE CONTROL PULSES

11.3 ANALOGUE AVR (AUTO VOLTAGE REGULATOR) CONTROL

AVR output can be an analogue output, or a digital pulse output. Analogue output is detailed here; digital pulse output is detailed in chapter 11.2.

AVR control is used to manage Voltage set points, Voltage Synchronization (U=U), kVAR load sharing and Power Factor regulation.

To set AVR control correctly:

- Start engine in **[Manu]** mode,
- Set Gain E1103:= 0 and Offset E1104:=0 on GENSYS 2.0.
- Set the AVR system to 400 V_{AC} using its potentiometer.
- Enter maximum correction (E2038 = + 7000) with **[Shift] + [+]** buttons.
- From the following table, choose the best values for Gain and Offset to obtain 430V_{AC} ±5V:

GAIN	OFFSET
0	0
255	0
255	255
0	255

TABLE 21 - AVR: GAIN AND OFFSET

If necessary, modify Gain and then Offset to obtain 430V_{AC} ±5.

- Enter minimum correction (E2038 = - 7000) with **[Shift] + [-]** buttons, then check that you have 370V_{AC} ±5
- Set to no correction (E2038 = 0) and check that you have 400V_{AC}.

Gain and Offset adjustment if you cannot obtain 400V_{AC} on the AVR: adjust the maximum voltage with the AVR potentiometer, which is normally below 400V_{AC}. Choose the best values for Gain and offset to obtain the maximum deviation.

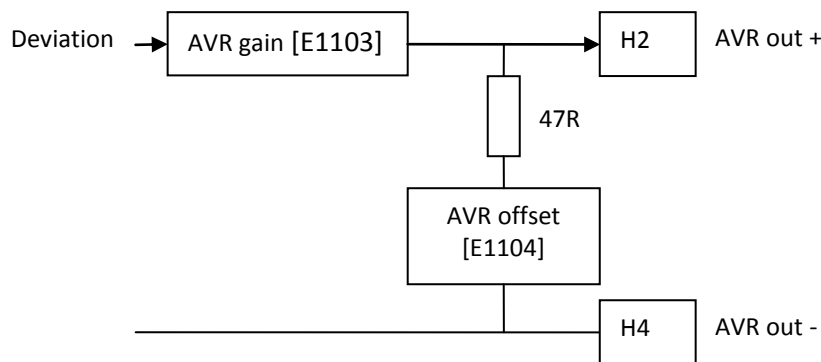

FIGURE 47 - VOLTAGE OUTPUT

See table below for preset settings. For specific settings contact your dealer.

Manufacturer	Model	AVR gain [E1103]	AVR offset [E1104]	Terminal H2	Terminal H4	Comment
STAMFORD	MX341	255	0	A2	A1	TRIM pot of AVR fully CW
	MX321	255	0	A2	A1	TRIM pot of AVR fully CW
	SX440	155	0	A2	A1	TRIM pot of AVR fully CW
BASLER	AEC63-7 AVC63-4 AVC63-4A APR63-5 APR125-5 SSR63-12	240	240	6	7	Remove shunt
	DECS32-15-xxx DECS63-15-xxx DECS125-15-xxx DECS300	-	-	-	-	Use VAR control included in the DECS.
	VR63-4	240	240	VAR+	VAR-	Remove the shunt
	MARATHON ELECTRIC	DVR2010	100	0	Aux input A	Aux input B
	DVR2000	-	-	-	-	Replace with SE350 or DVR2000E
AVK	Cosimat N+	255	0	Pot +	Pot -	
	MA329	155	0	A2(+)	A1(-)	
MarelliMotori	M8B	240	240	P	Q	Remove the shunt PQ
	M8B400	0	0	8	6	470nF capacitor between 8 and M. Don't connect shield.
	M405A640	0	0	6	8	470nF capacitor between 6 and M. Don't connect shield.
KATO	K65-12B K125-10B	255	0	2 Or 4	3 Or 7	Jumpers have to be removed.
MECC ALTE SPA	UVR6	250	200	Pot +	Pot -	50kΩ in serial with H2
LEROY SOMER	R450	150	230	Pot input +	Pot input -	Add shunt to select 50Hz Remove LAM
	R449	253	255	Pot input +	Pot input -	Remove the shunt
	R448	253	255	Pot input +	Pot input -	Remove the shunt
	R221	100	241	Pot input +(6)	Pot input - (7)	Remove the shunt. Pot ineffective
	R230	253	255	Pot input +	Pot input -	Remove the shunt

Manufacturer	Model	AVR gain [E1103]	AVR offset [E1104]	Terminal H2	Terminal H4	Comment
CATERPILLAR	DVR KVAR/PF	130	210	7	45	
	VR6	130	245			1.5kΩ in serial with H2
	CDVR	255	100	P12.6	P12.3	
SINCRO	FB	0	0	EXTPOT+	EXTPOT-	Remove the shunt , potentiometer V of AVR fully CCW

TABLE 22 - AVR PARAMETERS

11.4 RELAY OUTPUT

11.4.1 BREAKERS

GENSYS 2.0 is equipped with 4 NO relays (at rest) for breaker control:

- ❖ 2 relays to control the generator breaker - one for opening (E4) and one for closing (E5).
- ❖ 2 relays to control the mains breaker - one for opening (E1) and one for closing (E2).

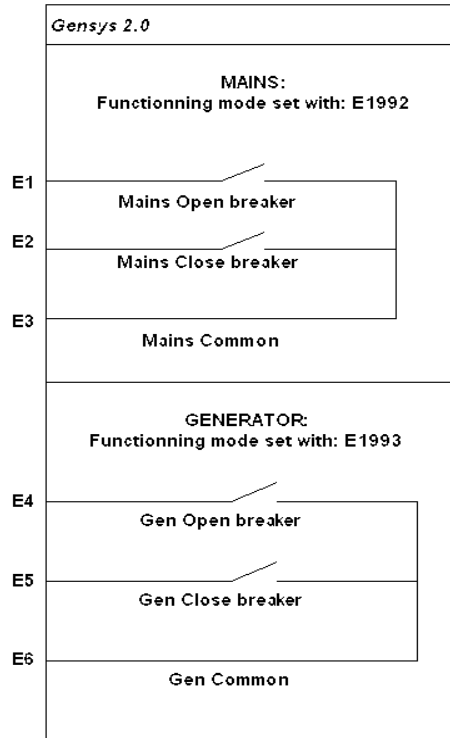

FIGURE 48 - BREAKERS WIRING

These outputs allow you to control various types of breakers. This chapter explains available setups and their associated variables.

Variables	
E2000	Digital input for MAINS breaker feedback
E2001	Digital input for GENSET breaker feedback
E2016	GENSET breaker control
E2017	MAINS breaker control
E1149	Delay before breaker opening/closure failure
E1992	Type of MAINS breaker relay working mode
E1993	Type of GENSET breaker relay working mode
E1994	Time before undervoltage trip coil control contact closure
E1995	Time before a new closure request is authorized
E1893	Trip coil minimum pulse length.

TABLE 23 - USED VARIABLES FOR BREAKERS SETTING

Variables [E2016] and [E2017] let you see the breaker output control. Whatever the type of breaker control, a value of 1 mean “close the breaker” while a 0 mean “open the breaker”.

Variables [E2000]/[E2001] and GENSYS 2.0 front panel let you see the breaker feedback. (1 when breaker is closed).

When GENSYS 2.0 tries to open/close a breaker, a maximum is allowed before getting the corresponding feedback from the breaker. This delay is set to 5 seconds (factory) and can be changed by adjusting parameter [E1149] in menu “Configuration/Modification by variable n”.

1/ Working modes

The “Configuration/Outputs/Breakers” menu allows you to choose the working mode of these relays via parameter [E1992] for the MAINS and [E1993] for the generating set. Table below explains the different working modes featured by GENSYS 2.0.

E1992 (MAINS) / E1993 (GENSET)	Relay output mode	Chronogram
0	Continuous contact to open <i>E1 (Mains) / E4 (Genset)</i>	
	Positive pulse to close <i>E2 (Mains) / E5 (Genset)</i>	
1 (default setting) (Contactor)	Continuous contact to open <i>E1 (Mains) / E4 (Genset)</i>	
	Continuous contact to close <i>E2 (Mains) / E5 (Genset)</i>	
2	Undervoltage coil opening <i>E1 (Mains) / E4 (Genset)</i>	
	Pulse to close <i>E2 (Mains) / E5 (Genset)</i>	
3	Undervoltage coil opening <i>E1 (Mains) / E4 (Genset)</i>	
	Continuous contact to close <i>E2 (Mains) / E5 (Genset)</i>	
4 (Breakers without undervoltage coils)	Pulse to open <i>E1 (Mains) / E4 (Genset)</i>	
	Pulse to close <i>E2 (Mains) / E5 (Genset)</i>	
5	Pulse to open <i>E1 (Mains) / E4 (Genset)</i>	
	Continuous contact to close <i>E2 (Mains) / E5 (Genset)</i>	

TABLE 24 - BREAKER CONTROL CONFIGURATION

2/ Working of pulse or an undervoltage coil

For control using a pulse or an undervoltage coil, the necessary parameters are:

- ❖ [E1893]: pulse length.
- ❖ [E1994]: Undervoltage coil delay. This sets the time between the opening of the breaker and the closing of the undervoltage coil control contact.
- ❖ [E1995]: Undervoltage coil pause time. Sets the time between the closing of the undervoltage trip coil control contact (E1 or E4) and another breaker close request by the other contact (E2 or E5). This must be longer than the breaker reset time.

These values can be modified in the “*Configuration/ Modification by variable n*” menu.

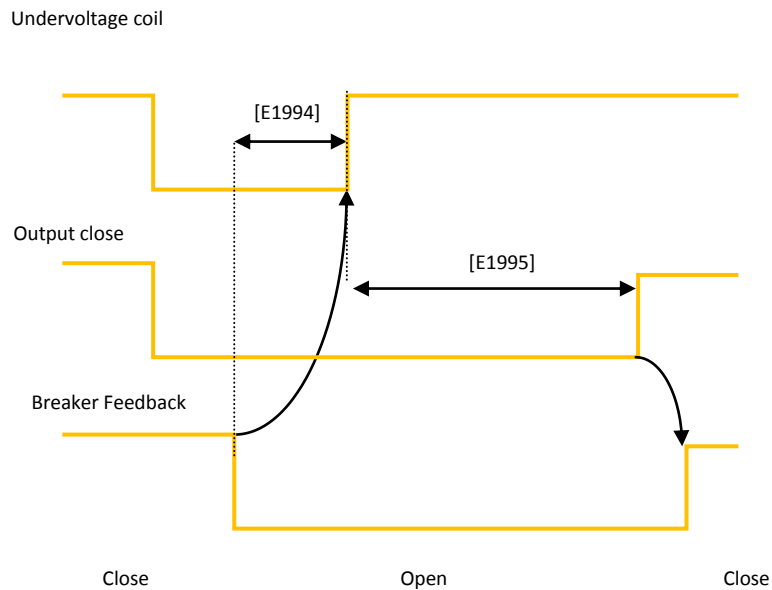

FIGURE 49- UNDERVOLTAGE COIL



WARNING:

Never switch from one mode to another when the plant is in use. An unwanted breaker state modification may occur.

3/ Close breaker condition

To close the generator breaker the following conditions have to be met:

Voltage must be between 70% (parameter E1432) and 130% (parameter E1433) of the nominal voltage (parameter E1107 or E1108).

Speed must be between 70% (parameter E1434) and 130% (parameter E1435) of the nominal speed (parameter E1080 or E1081).

11.4.2 FUEL & CRANK

The standard functions for these two relay outputs are for normal Fuel and Crank relay applications.

Crank is A1 (OUTPUT 6), and Fuel is A2 (OUTPUT 7). These two outputs are relays and are fully configurable through the “Configuration/outputs / Relay outputs” menu or through equations.

11.5 CRANK/FUEL/STARTER 2/ STARTER 3 FUNCTIONS

If there is an external crank relay, you can use the crank function [E2018] on a digital output. The behavior will be exactly the same as for the crank relay output (terminal A1).

If there is an external fuel relay, you can also use the fuel function [E2019] on a digital output. The behaviour will be exactly the same as for the fuel relay output (terminal A2).

For multiple starters (E1138 = 2 or 3), the outputs can be configured with the Starter 2 [E2267] and Starter 3 [E2268] functions. The number of attempts [E1134] is the global number and not the number of attempts per starter.

For example:

The number of attempts [E1134] is 4

The default starter [E1602] is 2

The number of starters [E1138] is 3

Output 1 (terminal C1) is configured as Starter 2 (E1260 = 2267)

Output 2 (terminal C2) is configured as Starter 3 (E1261 = 2268)

Should the engine refuse to start, the sequence will be:

C1 activated, crank rest, C2 activated, crank rest, A1 activated, crank rest, C1 activated, start failure

Note: For each starter's functions (Starters 1 to 3), there are separate parameters for starter disengagement relative to engine speed, which depend on starter type (electric, pneumatic...).

These parameters are available in the menu “Configuration/Engine/Crank settings”

Sta.1 drop out [E1325]:= 400rpm

Sta.2 drop out [E1326]:= 380rpm (level 2)

Sta.3 drop out [E1327]:= 380rpm.(level 2)

11.6 WATER PREHEAT / PRE-LUBRICATION / PRE-GLOW FUNCTIONS

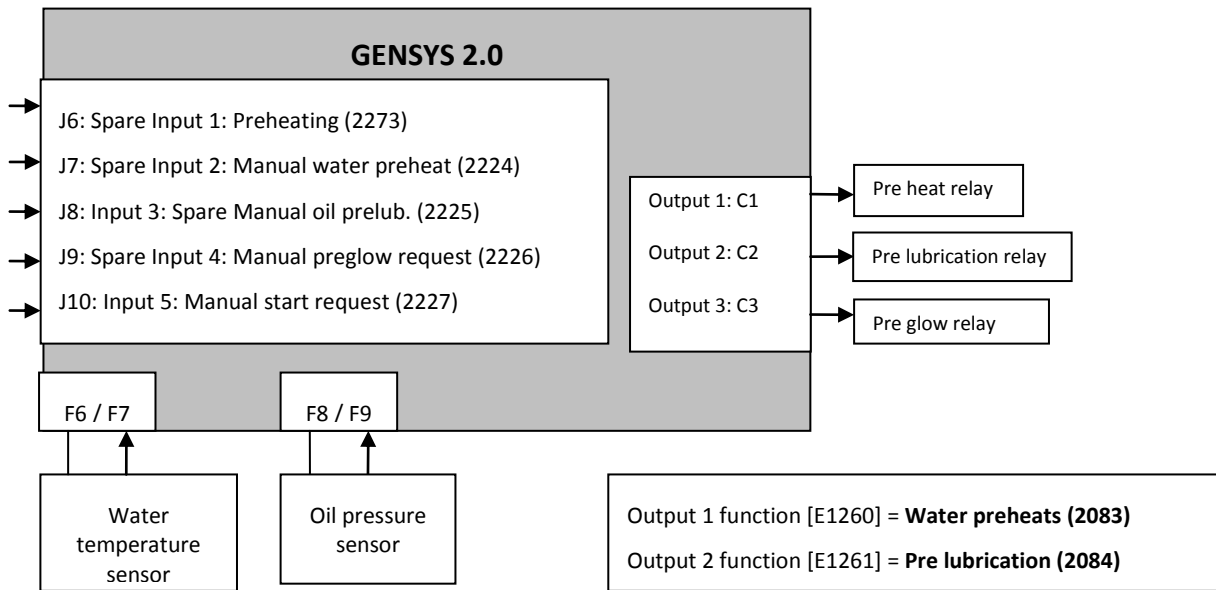

FIGURE 50 - CONNECTIONS FOR WATER PREHEAT, PRE LUBRICATION AND PRE GLOW

11.6.1 MANUAL MODE

Preheat is active when J7 is closed. The water temperature sensor isn't required.

Pre lubrication is active when J8 is closed. The oil pressure sensor isn't required.

Pre glow is active when J9 is closed, when you push GENSYS 2.0 start button, or if J10 is closed.

11.6.2 AUTOMATIC MODE

Pre-heat is activated if J6 is closed and if temperature is under the pre-set threshold ($E0030 < E1154$).

Note: The water temperature sensor is required in this instance.

Pre-lubrication will be activated when engine is in "pre-start" if pressure is under the threshold ($E0029 < E1155$). If the threshold [E1155] is 0, then pre-lubrication is active while the engine is in "pre-start". In the last case the oil pressure sensor isn't required.

Pre glow is active when engine state is "pre glow" or "start".

11.7 AIR FAN

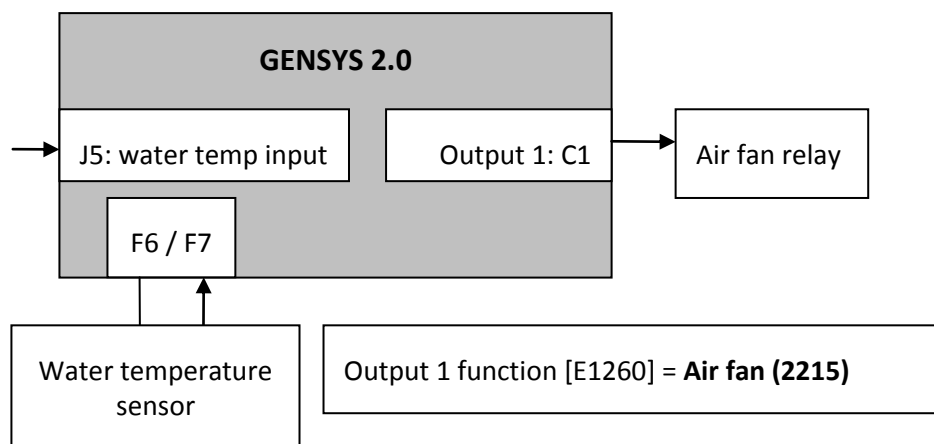

FIGURE 51 - CONNECTION FOR AIR FANS

In all cases, the AIR FAN will be activated if J5 is activated or if the “max water temp” protection (F6/F7 analogue input) is configured and triggers.

11.7.1 MANUAL MODE

AIR FAN output is activated if engine speed is other than 0.

11.7.2 AUTOMATIC MODE

AIR FAN is activated if temperature is over the pre-set threshold (E1178) and de-activated when water temperature is lower than 80% of the threshold. AIR FAN is not activated if engine is stopped.

11.8 FUEL FILLING/ COOLANT FILLING/ OIL FILLING

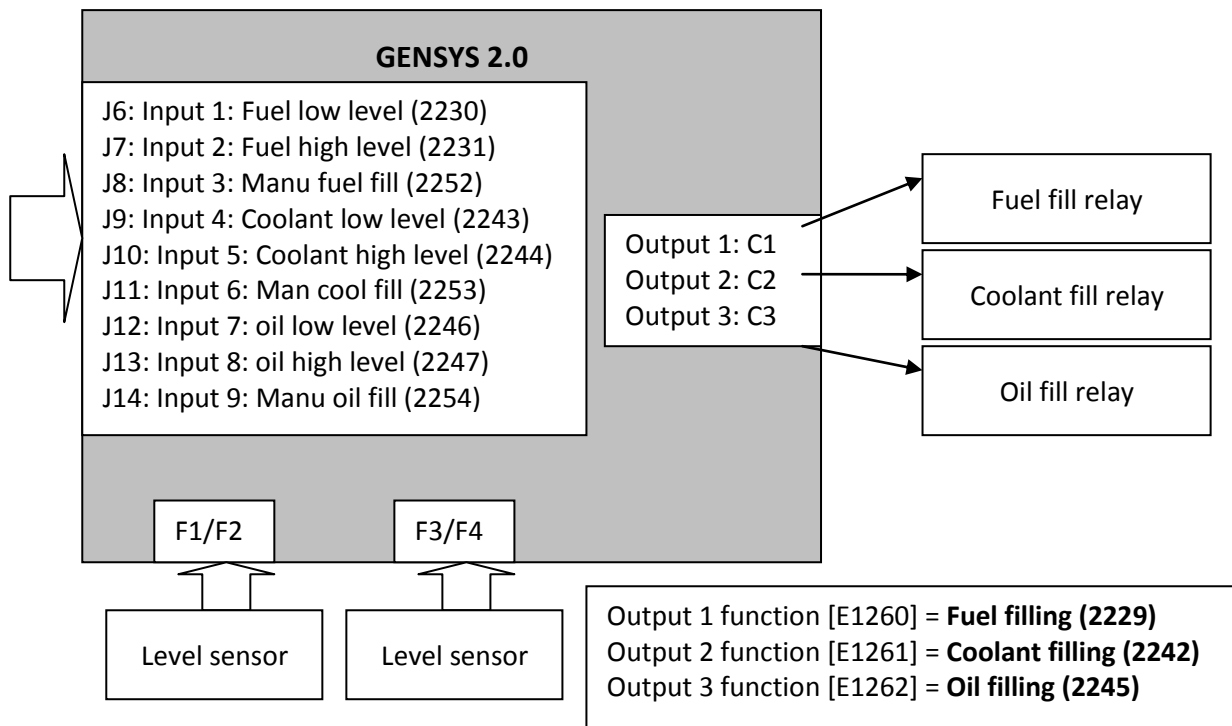

FIGURE 52 - CONNECTIONS FOR FILLING

Fuel/Oil/Coolant filling can be managed using one analog level sensor or two switches (one high level and one low level switch). Starting from firmware v4.00, analog sensors can be used directly without requiring any additional equation while modules with older firmware will require custom equations.

11.8.1 MANUAL MODE

In the example above, fuel filling output is only activated if J8 input is closed (J11/J14 for coolant or oil filling).

11.8.2 AUTOMATIC MODE

1/ Description

These filling functions are automatic and do not require any custom equation. To configure the filling function, you have to:

- Set the digital output as a fuel filling [E2229], coolant filling [E2242] or oil filling [E2245].
- Set the following parameters

Function	Filling		
	Fuel	Coolant	Oil
Filling input	E4085	E4088	E4091
Low level input	E4086	E4089	E4092
High level input	E4087	E4090	E4093

TABLE 25 - FILLING PARAMETERS IN AUTOMATIC MODE

The parameters « Filling input » allow selecting the resistive sensor to use among:

- Analog input 1 (F1-F2) : set filling input parameter to 31
- Analog input 2 (F3-F4) : set filling input parameter to 32
- Analog input 3 (F6-F7) : set filling input parameter to 30
- Analog input 4 (F8-F9) : set filling input parameter to 29

Parameters « Low level input » and «High level input » allow defining the filling thresholds.

Alternatively, two digital inputs can be set as low level and high level switches if no analog sensor is fitted.

2/ Example

If we use the same example as the automatic mode with equation (see §11.8.3) to fill the fuel tank, then parameters would be set as shown below:

E4085 = 31
 E4086 = 20
 E4087 = 80
 E1260 = 2229

Note: E1260 is the function associated to digital output 1.

11.8.3 AUTOMATIC MODE WITH EQUATIONS

1/ Description



Equations are required for analog sensor management in modules with firmware older than v4.00. The 3 filling features all have exactly the same behavior. Fuel filling will be described below. For the other functions, **fuel** is to be replaced by **coolant** or **oil** and the variable number by the values shown in the figure above.

Function	Filling		
	Fuel	Cooling	Oil
Low level input	E2230	E2243	E2246
High level input	E2231	E2244	E2247
Filling output	E2229	E2242	E2245

TABLE 26 - FILLING PARAMETERS IN AUTOMATIC MODE WITH EQUATIONS

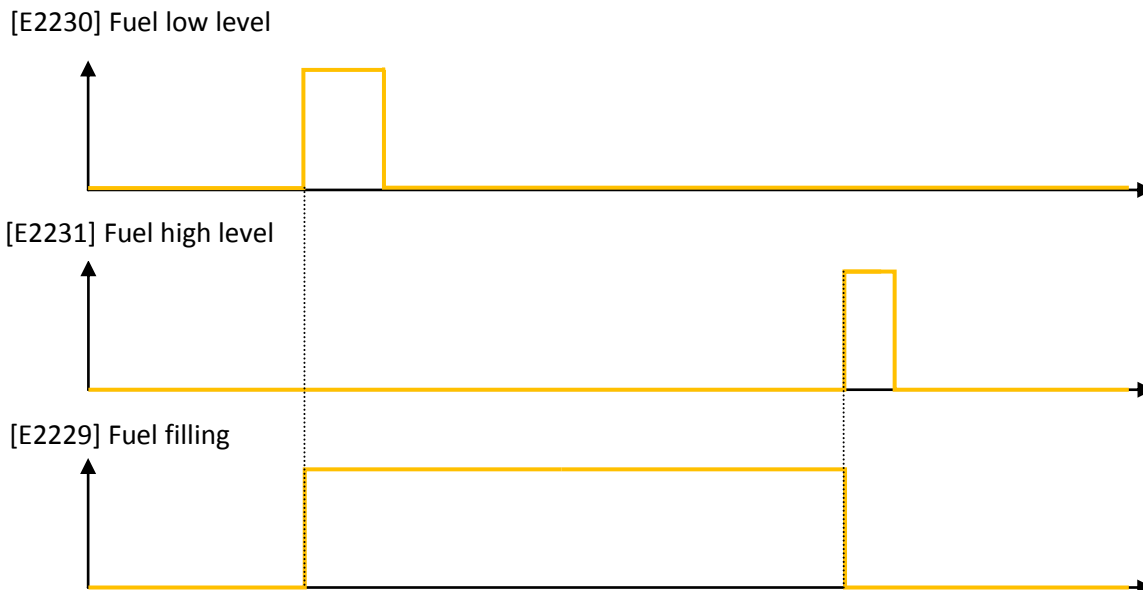

FIGURE 53 - FUEL FILLING DIAGRAM

2/ Example

If the tank is fitted with a fuel level sender that can be connected to an analogue input (F1/F2 or F3/F4), it is possible to calculate the fuel low/high limits using equations. The following example shows the case of filling a tank. It requires filling if it is less than 20% full and filling should stop when it reaches 80% full.

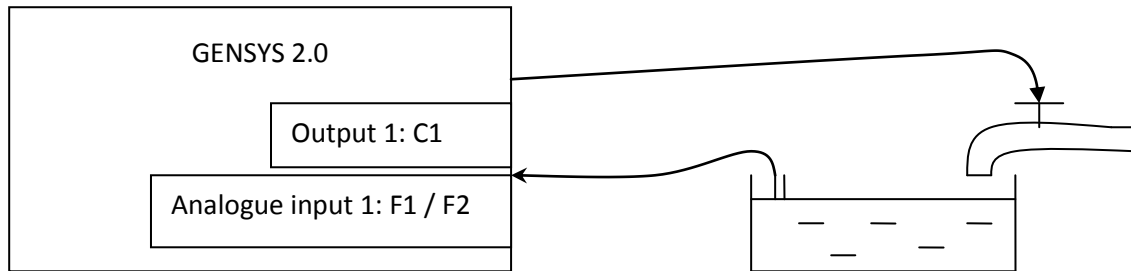

FIGURE 54 - FILLING EXAMPLE

E2230 is the low fuel level.

E2231 is the high fuel level.

E0031 is engine measure 1 (potentiometer input F1 / F2).

E2020 is the digital Spare output 1 which triggers the filling of the tank (C1 terminal).

```
PROG 1
BLOC
    E2230:=E0031 LT 40;
    E2231:=E0031 GT 80;
    E2020:=( E2230 OR E2020) AND (!E2231)
BEND
```

Note : Don't forget to configure output 1 in "Used by equations".

11.9 ANALOGUE LOAD SHARING LINE

It is possible to use traditional analogue load sharing lines (often called **Parallel lines**) with the GENSYS 2.0 product. The example shown is in association with a BARBER COLMAN product.

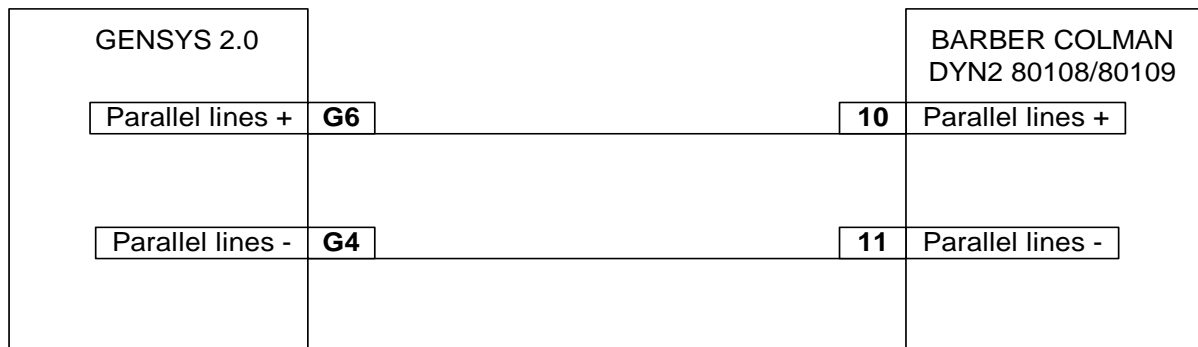

FIGURE 55 - WIRING PARALLEL LINES

Change the following parameters in menu "Configuration/Power plant" to activate the parallel lines:

- Load sharing [E1158]= Analog (0)
- Deadbus manage. [E1515]= NO (1)

11.10 WATCHDOG OUTPUT

A watchdog option is available using the C5 output. This option must be specified upon ordering your unit so that CRE Technology can activate it. For more information concerning this function, please contact CRE Technology.

12 I/O LINES

12.1 DIGITAL INPUT

They are divided into dedicated and configurable inputs.

For Digital inputs (J4 to J15) the following parameters can be set:

- ❖ Label: can be modified with parameters file.
- ❖ Validity: can be modified using configuration menu or equations.
- ❖ Direction: can be modified using configuration menu or equations.
- ❖ Delay: can be modified using configuration menu or equations.
- ❖ Function: can be modified using configuration menu or equations.

To modify a parameter through the menu, go to the configuration menu: “Enhanced configuration”/“Digital transistors output”. Choose the digital input to modify using the [<<] and [>>] soft keys to change page (2 inputs per page), and [↑] and [↓] to choose the parameter. The description of the function is given on the next line, and can be modified with the [+] and [-] keys.

The following table shows all input associated parameters.

	Not delayed value	Delayed value	Default label	Label	Validity	Direction	Delay	Function
J1	N.A.	E2000	Mains breaker	N.A.	N.A.	E1453	N.A.	N.A.
J2	N.A.	E2001	Gen breaker	N.A.	N.A.	E1454	N.A.	N.A.
J3	E2787	E2002	Remote start	N.A.	N.A.	E1455	E1990	N.A.
J4	E2788	E2804	Oil Pres/In J4	L2804	E4035	E1456	E1998	E1996
J5	E2789	E2805	Wat.Temp/In J5	L2805	E4036	E1457	E1999	E1997
J6	E2790	E2806	Spare Input J6	L2806	E1287	E1297	E1277	E1267
J7	E2791	E2807	Spare Input J7	L2807	E1288	E1298	E1278	E1268
J8	E2792	E2808	Spare Input J8	L2808	E1289	E1299	E1279	E1269
J9	E2793	E2809	Spare Input J9	L2809	E1290	E1300	E1280	E1270
J10	E2794	E2810	Spare InputJ10	L2810	E1291	E1301	E1281	E1271
J11	E2795	E2811	Spare InputJ11	L2811	E1292	E1302	E1282	E1272
J12	E2796	E2812	Spare InputJ12	L2812	E1293	E1303	E1283	E1273
J13	E2797	E2813	Spare InputJ13	L2813	E1294	E1304	E1284	E1274
J14	E2798	E2814	Spare InputJ14	L2814	E1295	E1305	E1285	E1275
J15	E2799	E2815	Spare InputJ15	L2815	E1296	E1306	E1286	E1276

TABLE 27 - INPUT PARAMETERS

12.1.1 CONFIGURABLE INPUT LABEL

This is the name you give to the input. The name will be displayed in the info, alarm, and fault screens if so programmed. You can change the label using the menu, or you can download a text parameter file via the Internet connection or via the **CRE Config** software.

12.1.2 VALIDITY

Validity input variable numbers can be set as:

Num	Label	Function
2330	Never	Never active: should be selected if you do not use the input.
2329	Always	Always active: input will be monitored as long as GENSYS 2.0 has power.
2192	Post-Start	Input will be monitored at the end of the "safety on delay" [E1514] ⁽¹⁾
2331	Stabilized	Input will be monitored when genset is ready for use.
2332	Spare scenario	Input will be monitored as defined in equations.

TABLE 28 - INPUT VALIDITY DOMAIN

(1) Safety ON time configuration is accessible via "Enhanced configuration/Start / stop sequence" menu, on the "Timers" page. Parameter is configured in [E2192], and counter value is in [E1514].

12.1.3 DIRECTION

For each of the inputs, two options are available:

Num	Label	Function
0	Norm open	Should be selected in normal cases unless the input is used for protection.
1	Norm close	Normally closed; should be selected if the input is normally connected to 0V and is opened when active

TABLE 29 - INPUT DIRECTION DOMAIN

12.1.4 DELAY

For each input, delay can be defined in 100ms steps between 0 and 6553s.

12.1.5 INPUT FUNCTIONS

Function input variable numbers can be set as indicated in the following table.

Value	Function	Description
0	Unused	Should be selected if you do not use the input.
1	Used by equations	 If the function associated to the input is not listed below, choose "used by equations"
2224	Manual water preheat request	Can be chosen if a coolant pre heating system is installed; can be used in conjunction with digital transistor output. Will only work in manual mode.
2225	Manual oil prelub. request	Can be chosen if a pre lubrication pump is installed on the engine; can be used in conjunction with digital transistor output. Will only work in manual mode.
2226	Manual preglow request	Can be chosen if pre heating plugs are installed on the engine; can be used in conjunction with digital transistor output. Will only work in manual mode.
2205	Fault reset request	If an external reset is wired to the input, choose fault reset request. This will have the same effect as pressing the reset key on the GENSYS 2.0 front panel on Fault and Alarm displays.
2227	Manual start request	To be selected if a remote start command is to be installed.

Value	Function	Description
2228	Manual stop request	To be selected if a remote stop command is to be installed - different from emergency stop.
2233	Manual +f request	To be selected if a remote frequency increasing command is to be installed.
2234	Manual -f request	To be selected if a remote frequency decreasing command is to be installed.
2235	Manual +U request	To be selected if a remote voltage increasing command is to be installed.
2236	Manual -U request	To be selected if a remote voltage decreasing command is to be installed.
2231	Fuel high level	To be selected for a max level sensor or a calculation; can be used in conjunction with digital transistor output.
2230	Fuel low level	To be selected for a min level sensor or a calculation; can be used in conjunction with digital transistor output.
2244	Coolant high level	To be selected for a max level sensor or a calculation; can be used in conjunction with digital transistor output.
2243	Coolant low level	To be selected for a min level sensor or a calculation; can be used in conjunction with digital transistor output.
2247	Oil high level	To be selected for a max level sensor or a calculation; can be used in conjunction with digital transistor output.
2246	Oil low level	To be selected for a min level sensor or a calculation; can be used in conjunction with digital transistor output.
2197	Securities inhibition	Will inhibit all protections. These alarms and faults remain listed in the faults and alarm logging.
2198	No cranking	To be selected to prevent engine from starting.
2210	Ext. secu.(Hard shut down)	If external protections are installed, for immediate stop of the engine.
2209	Ext. fault(Soft shut down)	If external protections are installed, for immediate opening of genset breaker and stopping of the engine after cooling down timer has expired.
2208	External alarm	If external protections are installed, to report an alarm.
2217	Generator electrical fault	If external protections are installed, protection will open genset breaker and try to synchronize again.
2218	Mains electrical fault	If external protections are installed, protection will open mains breaker and try to synchronize again.
2681	Non-essential trip alarm	Remote non-essential load.
2736	Help + Fault (Soft shut down)	To be selected to stop the engine after cool down. The GENSYS 2.0 will ask another engine to start before stopping itself.
2737	Help + Gen Electrical Fault	To be selected to activate the "gen electrical fault" action. The GENSYS 2.0 will ask another engine to start before stopping itself.
2655	Remote stop horn	To be selected to stop the external Horn. Useful if one output is set as "Horn". to be used in conjunction with digital outputs
2336	Gen. breaker Close manual	To be selected if manual remote close button for genset breaker is programmed.
2337	Gen. breaker Open manual	To be selected if manual remote open button for genset breaker is programmed.

Value	Function	Description
2338	Mains breaker Close manual	To be selected if manual remote close button for mains breaker is programmed.
2339	Mains breaker Open manual	To be selected if manual remote open button for mains breaker is programmed.
2001	Generator breaker Aux	To be selected if a different input for the generator breaker position is required.
2000	Mains breaker Aux	To be selected if a different input for the mains breaker is required.
2002	Remote start	To be selected if a different input for remote start is required.
2003	Oil pressure fault	To be selected if a different input for oil pressure fault is required.
2004	Water temperature fault	To be selected if a different input for water temperature fault is required.
2241	Priority generator	To be selected if load/unload features depend on a priority genset; see Configuration -> load / unload menu
2260	Auto mode forced	Will inhibit the "Manu" key on the GENSYS 2.0 front panel. GENSYS 2.0 will never be in Manu mode even if you press the GENSYS 2.0 "Manu" key.
2261	Manual mode forced	Will put GENSYS 2.0 into Manual mode. Will have the same effect as the GENSYS 2.0 "Manu" key.
2661	Running with breaker open	Allows the engine to run in Auto mode without paralleling or closing its breaker.
2279	Select speed 2	Will select the second speed set point.
2280	Select volt 2	Will select the second voltage set point.
2281	Select KW 2	Will select the second power output set point.
2513	Select Pnom 2	Will select the second nominal power (active and reactive).
2273	Preheating	Can be chosen if a coolant pre heating system is installed; can be used in conjunction with a digital transistor output. Will work in auto mode.
2252	Manu fuel fill	To be selected for a manual fuel refill; to be used in conjunction with digital outputs.
2253	Manu cool fill	To be selected for a manual coolant refill; to be used in conjunction with digital outputs.
2254	Manu oil fill	To be selected for a manual lubricant refill; to be used in conjunction with digital outputs.
2766 2930 2932 2934	Heavy consumer request #1 Heavy consumer request #2 Heavy consumer request #3 Heavy consumer request #4	To be selected to activate "Heavy consumer control" sequence. See §15.1 for more details.
5000	Unload brk1 in	Order output to close generator breaker n°1 upon startup if the nominal power<E4001
5001	Unload brk2 in	Order output to close generator breaker n°1 upon startup if the nominal power<E4002
5002	Unload brk3 in	Order output to close generator breaker n°1 upon startup if the nominal power<E4003
5003	Unload brk4 in	Order output to close generator breaker n°1 upon startup if the nominal power<E4004
5004	Unload brk5 in	Order output to close generator breaker n°1 upon startup if the nominal power<E4005

Value	Function	Description
2515	External GE OK	Used to indicate that the generator is ready when using an external start module. (see §14.5)
2928	Unload(chk kW)	External request to stop a genset. Will be done if stopping this engine will not overload the power plant according to load dependent start/stop setup.
2850	Manual main back ⁽¹⁾	Order to synchronize the generator with the mains after a mains electrical fault (see §14.2)

TABLE 30 - INPUT FUNCTIONS

(1) Available only in level 2

12.1.6 DEDICATED INPUTS

In the menu list, each input is named after its pin number on the wiring of GENSYS 2.0. Polarity can be normally open or normally closed. Program this according to the wiring you will have on site.

As a reminder:

- ❖ J1 is the Mains breaker state.
- ❖ J2 is the Genset breaker state.
- ❖ J3 is the remote start input.

12.2 DIGITAL OUTPUTS

Outputs 1 to 5 are wired on the C connector. These outputs are electronically protected, but not isolated.

Outputs 1 to 5 (E1260, E1261, E1262, E1262, E1264): function and polarity can be defined.

Relay outputs A1 "Crank" and A2 "Fuel" can also be set up for other functions. On industrial range, initial settings are "Crank" and "Fuel". Polarity cannot be changed for these relay outputs. A1 "Crank" output function can be set with [E1989]; A2 "Fuel" output function is set with [E1916].

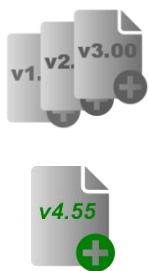

On firmware versions before v4.55, relay output setup as "not used" were still working as CRANK and FUEL function. Starting from v4.55, unused configuration really means that output relay will never be activated.

Yet in order to keep a consistent behavior on existing sites that are upgraded with newer firmware, parameters E1916 and E1989 will be automatically adapted if you send a TXT file from an old firmware (i.e. from v1.00 to v4.04) into a newer unit (with firmware v4.55 or later). This means that an old text file containing "V1916 0" or "V1989 0" in the PARAMETERS section will result in newer units in V1916 = 2019 (FUEL) and V1989 = 2018 (CRANK). You will be informed of such event by the compilation result :

WARNING 002: V1989 adjusted to match new firmware usage.

WARNING 003: V1916 adjusted to match new firmware usage.

12.2.1 OUTPUT CONFIGURABLE FUNCTIONS

Value	Function	Description
0	Unused	To be selected if output is not wired.
1	Used by equations	 To be selected if output is used by equations.
2083	Water preheat	Can be used for coolant pre heat system.
2084	Pre-lubrication	Can be used for pre lubrication pump.
2085	Pre glow	Can be used for cylinder pre heating plugs
2018	Crank	Can be used for external crank relay
2019	Fuel	Can be used for external fuel relay
2211	Excitation	Can be used to activate an external AVR in a static synchronizing configuration [see Configuration -> power plant overview] Will activate an external excitation relay when engine state is: engine ready; generator ready; wait after stop request; cool down. In the case of dynamic paralleling [E1177 = 0], the output will also be activated in the start , warm up, and nominal speed states.
2212	Fuel (energize to stop)	Can be used for an external relay if fuel solenoid has to be energized to stop the engine. Will activate an external fuel relay [Energize to stop] when engine is running [E0033 > 0] and if there is an engine fault [E2046] or a stop request. In Manual mode the stop request will be the "Stop key" [E2047] or the "Manual stop request" [E2228] or no fuel [E2019 off].
2016	Generator breaker order	Can be used to open or close genset breaker. The outputs configured with this function will have exactly the same behavior as the outputs for the Generator breaker [E4 to E6].
2017	Mains breaker order	Can be used to open or close genset breaker. The outputs configured with this function will have exactly the same behavior as the outputs for the Mains breaker [E1 to E3].
2316	Faults summary	Will activate an output when there is at least one "fault" triggered by GENSYS 2.0.
2202	Alarms summary	Will activate an output when there is at least one "alarm" triggered by GENSYS 2.0.
2204	Hard shut down summary	Will activate an output when there is at least one "serious fault" (securities) triggered by GENSYS 2.0.
2203	Soft shut down summary	Will activate an output when there is at least one "minor fault" triggered by GENSYS 2.0.
2200	GE elec faults summary	Will activate an output when there is at least one "generator electrical fault" triggered by GENSYS 2.0.
2201	Mains elec. faults summary	Will activate an output when there is at least one "mains electrical fault" triggered by GENSYS 2.0.
2724	Trip out 1	Output activated by the protection in the "Non-essential consumer trip" sequence. See §15.2; This is the first trip; Non-essential consumer trip

Value	Function	Description
2725	Trip out 2	Output activated by the protection in the "Non-essential consumer trip" sequence. See §15.2; This is the 2nd trip activated [E1894] seconds after the previous one. Non-essential consumer trip
2726	Trip out 3	Output activated by the protection in the "Non-essential consumer trip" sequence. See §15.2; This is the 3rd trip activated [E1894] sec. after the previous one. Non-essential consumer trip
2727	Trip out 4	Output activated by the protection in the "Non-essential consumer trip" sequence. See §15.2; This is the 4th trip activated [E1894] sec. after the previous one. Non-essential consumer trip
2728	Trip out 5	Output activated by the protection in the "Non-essential consumer trip" sequence. See §15.2; This is the 5th trip activated [E1894] sec. after the previous one. Non-essential consumer trip
2774	TripOut direct	Output activated by the protection in the "Non-essential consumer trip" sequence. See §15.2; This one is activated directly. Non-essential consumer trip
2213	Smoke limiter	Output to be used if external speed controller has smoke limit input. Will activate an output upon start. In Manual mode: when GENSYS 2.0 start button is pressed or with a manual start request. In Auto mode: when engine state is "Start", "Warm up" and "Nominal speed".
2214	Warm up	This output will activate when engine is warming up. Will activate an output at start. In Manu mode, when GENSYS 2.0 start button is pressed or with a manual start request and while the warm up timer [E2061] is different from 0. In Auto mode, when engine state is "Start" and "Warm up".
2206	Horn	Can be used for external horn or flashing light relay; output will activate whenever a protection triggers. The output will be activated when a generator electrical fault [E2200], mains electrical fault [E2201], alarm [E2202], fault [E2203] or security [E2204] triggers, and will reset when the GENSYS 2.0 horn button is pressed. Parameter E1991 can be used to select the maximum duration of horn activation (0 means the horn will buzz until being manually stopped).
2215	Air fans	To be wired to fan relay.
2219	Generator breaker Close	Can be used to close genset breaker ⁽¹⁾
2221	Generator breaker Open	Can be used to open genset breaker ⁽¹⁾
2220	Mains breaker Close	Can be used to close mains breaker ⁽¹⁾ .
2222	Mains breaker Open	Can be used to open mains breaker ⁽¹⁾ .
2229	Fuel filling	Can be used for an external fuel pump in conjunction with "Fuel low level" and "Fuel high level" or "Manu fuel fill" functions attributed to spare digital inputs.
2242	Coolant filling	Can be used for a compressor in conjunction with "Coolant high level" and "Coolant low level" or "Manual air fill" functions attributed to spare digital inputs.

Value	Function	Description
2245	Oil filling	Can be used for oil level filling in conjunction with "Oil high level" and "Oil low level" or "Manu oil fill" functions attributed to spare digital inputs.
2341	+f	The behavior will change according to the mode. In Manual mode, if you program the +f function, the output will be activated when you press the GENSYS 2.0 [+] key or if there is a "Manual +f request" [E2233]. Likewise for the other functions; -f activates with [-] key or "Manual -f request [E2234]; -f activates with [+] [SHIFT] keys or "Manual +U request [E2235]; -f activates with [-] [SHIFT] keys or "Manual -U request [E2236]. In Auto mode, these functions will control a speed / voltage regulator requiring +/- contacts. You can configure the no action range for the speed [E1598] and for the voltage [E1599], the impulsion delay for the speed [E1600] and for the voltage [E1601].
2342	-f	
2343	+U	
2344	-U	
2223	Damper	Will activate in stop sequence to stop the engine when damping flap is fitted. Will be activated when there is an engine fault [2046].
2232	Lamp test	This will activate the output whenever the light test key is pressed on the front panel of GENSYS 2.0, or an input programmed for light test is active
2331	Generator ready	Output will be active when start sequence is completed and voltage is present at the generator. In Auto mode, the output will be activated when the engine state is "Gen ready". In Manual mode the output will be activated when the speed [E0033] is positive.
2240	Generator stopped	Output will be active when genset is at rest. In Auto mode, the output will be activated when the engine state is "Waiting". In Manual mode the output will be activated when there is no speed [E0033].
2262	[+] key	These key are useful in Manu mode to control the speed and the voltage.
2263	Shift & [+] keys	
2264	[-] key	
2265	Shift & [-] keys	
2056	Manu mode	Output will be active when GENSYS 2.0 is in manual mode.
2267	Starter 2	Will be active when a second engine starting system is present and programmed in Configuration -> Start sequence menu.
2268	Starter 3	Will be active when a third engine starting system is present and programmed in Configuration -> Start sequence menu.
2269	Ana1 threshold	Output will be active when the measurement of analogue input 1 [oil pressure] is under the set value; it will not de-activate until measurement is over [set value + hysteresis value]. To be programmed and used with the following parameters: "Oil threshold" [E1175], "Oil hysteresis" [E1176].
2270	Ana2 threshold	Output will be active when the measurement of analogue input 2 [water temperature] is over the set value; it will not de-activate until measurement is under [set value minus hysteresis value]. To be programmed and used with the following parameters, "Wat temp thresh" [E1426], "Wat temp hyst." [E1427]

Value	Function	Description
2271	Ana3 threshold	Output will be active when the measurement of analogue input 3 [1st spare measure] is over or under the set value; it will not de-activate until measurement is under or over [set value +/- hysteresis value]. To choose the direction of the protection, see Configuration -> engine/battery settings [SS measure 1 min or max thresh.]. To be programmed and used with the following parameters: "Meas 1 thresh." [E1428], "Meas 1 hyst." [E1429].
2272	Ana4 threshold	Output will be active when the measurement of analogue input 4 [2nd spare measure] is over or under the set value; it will not de-activate until measurement is under or over [set value +/- hysteresis value]. To choose the direction of the protection, see Configuration -> engine/battery settings [SS measure 2 min or max thresh.]. To be programmed and used with the following parameters: "Meas 2 thresh." [E1430] and "Meas 2 hyst." [E1431].
2525	GE available	Will activate when the genset has completed its start sequence in auto mode - can be used for external logic. The output will be activated when GENSYS 2.0 is in Auto mode and the power state [E2071] is not in fault.
2767	Heavy consumer authorization #1	Output activated when starting heavy consumer number 1 is allowed in the "Heavy consumer control" sequence. See below, §15.1
2931	Heavy consumer authorization #2	Output activated when starting heavy consumer number 2 is allowed in the "Heavy consumer control" sequence. See below, §15.1
2933	Heavy consumer authorization #3	Output activated when starting heavy consumer number 3 is allowed in the "Heavy consumer control" sequence. See below, §15.1
2935	Heavy consumer authorization #4	Output activated when starting heavy consumer number 4 is allowed in the "Heavy consumer control" sequence. See below, §15.1
2838	Fuel (inverted)	Inverted of the Fuel output [E2019]. This function allows to use the Fuel relay output A2 with an inverted polarity.
5000	Unload brker 1	Order output to close generator breaker n°1 upon start if the nominal power<E4001
5001	Unload brker 2	Order output to close generator breaker n°1 upon start if the nominal power<E4002
5002	Unload brker 3	Order output to close generator breaker n°1 upon start if the nominal power<E4003
5003	Unload brker 4	Order output to close generator breaker n°1 upon start if the nominal power<E4004
5004	Unload brker 5	Order output to close generator breaker n°1 upon start if the nominal power<E4005
2927	Syncing U=U	The unit is actually in voltage synchronization mode (to parallel with the Mains or busbar).
2320	Alternator voltage presence	Will activate when the generator is started and generator voltage is OK.
2883	GE on load	Will activate when generator voltage is OK and GE breaker is close.

TABLE 31 - DIGITAL OUTPUTS FUNCTION

(1) Generates a 1s pulse on the output, when Generator/Mains breaker [E2016/E2017] wants to close/open

12.2.2 POLARITY

For each of the five outputs, two options are possible:

- **NE:** normally energized; the output will de-energize when required, according to its function.
- **ND:** normally de-energized; the output will energize when required.

12.3 ANALOGUE INPUT (VIA CRE CONFIG SOFTWARE)

All analog inputs settings (unit, accuracy, calibrage) are done via **CRE Config** software or by the parameters file.

12.3.1 OIL PRESSURE CONFIGURATION

You can now choose units (mBar, Bar, kPa, PSI) and degree of accuracy (number of digits after decimal point):

- 1
- 0.1
- 0.01
- 0.001

12.3.2 WATER TEMPERATURE CONFIGURATION

You can now choose units (°C or °F) and degree of accuracy (number of digits after decimal point):

- 1
- 0.1
- 0.01
- 0.001

12.3.3 CONFIGURATION OF ENGINE MEASUREMENTS 1 AND 2

Spare Analogue measurements 1 and 2: they can be named, and the unit to be displayed chosen among the following:

No unit, V, kV, mA, A, kA, Hz, kW, kWh, kVAR, kVARh, rpm, %, Bar, mBar, kPa, PSI, °, °C, °F, L, Gal, s, h, days, Hz/s, m3/h, L/h, Gal/h.

You can then choose the degree of accuracy (number of digits after decimal point):

- 1
- 0.1
- 0.01
- 0.001

12.3.4 CALIBRATION OF ANALOGUE INPUTS

1/ Oil and water 0-400 Ohm sensors

Oil Pressure and Water Temp: this menu relates to the dedicated analogue inputs (oil pressure and coolant temperature). Please enter the pressure or temperature read by your sensors according to the resistance shown in the table.

Oil Temperature calibration points are [E1188 to E1198], which correspond to 0 to 400 Ohm

Water Temp calibration points are [E1199 to E1209], which correspond to 0 to 400 Ohm.

Please enter calibration points using this table:

Ohm	VDO 5b	VDO 10b	VDO 25b	AC 10b	Veglia 8b	Veglia 12b	Dat 10b
0	-345	-487	-2 120	-260	8 442	12663	12142
40	834	1 585	3 777	4 316	6 922	10387	8962
80	2 014	3 945	9 674	8 892	5 402	8111	6102
120	3 193	6 245	15 571	13 468	3 882	5835	3562
160	4 372	9 050	21 469	18 044	2 362	3559	1342
200	5 552	12 220	27 366	20 000	842	1283	-558
240	6 731	20 000	30 000	20 000	-678	-993	0
280	7 911	20 000	30 000	20 000	0	0	0
320	9 090	20 000	30 000	20 000	0	0	0
360	10 270	20 000	30 000	20 000	0	0	0
400	11 449	20 000	30 000	20 000	0	0	0

TABLE 32 - OIL PRESSURE CALIBRATION POINTS

Ohm	VDO 120°	VDO 150°	Veglia	Datcon L	Datcon H	AC
0	145	1000	1000	1000	0	1000
40	96	119	140	104	40	104
80	74	94	118	78	80	78
120	63	80	105	63	120	63
160	55	70	96	52	160	52
200	49	62	89	43	200	43
240	44	56	83	36	240	36
280	40	51	78	31	280	31
320	37	46	74	26	320	26
360	34	42	70	21	360	21
400	32	38	67	17	400	17

TABLE 33 - WATER TEMP CALIBRATION POINTS

2/ Engine measurements 1 and 2

Spare 1 engine measure calibration points are [E1210 to E1220].

Spare 1 engine measure impedance points are [E1188 to E1198].

Spare 2 engine measure calibration points are [E1232 to E1242].

Spare 2 engine measure impedance points are [E1199 to E1209].

For each of the two spare sensors, this table shows the given value (left side) for each of ten sampled resistive values in ohm (right side). Intermediate values are obtained with linear approximation.

E. g.: min = 3000, max =6000, gives the values corresponding to 3000, 3300, 3600, 3900, 4200, 4500, 4800,..., 5700, 6000 Ohms. These can be used in equations or displayed.

12.3.5 USE SPARE ANALOGUE INPUT AS DIGITAL INPUT



If necessary, it is possible to use an analogue input as a digital input.

1/ Purpose

Use spare analogue input (spare 1 and 2, connections F1-F2 and F3-F4) as digital input.

2/ Configuration

Spare analogue input calibration table should be set as shown below to mimic digital input.

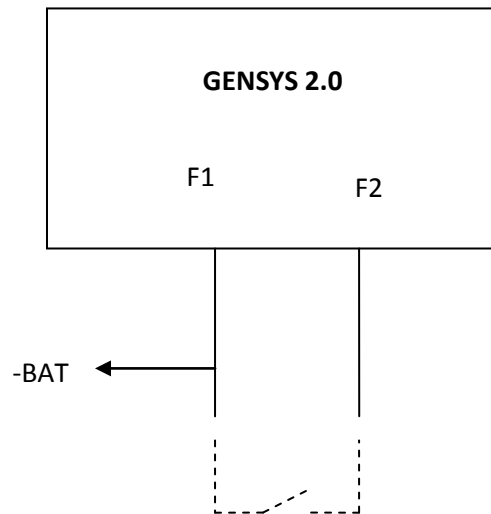

3/ Parameters

Calibration table for a normally closed input:

V1210	0	N	Spare1 calib1	-32768	+32767
V1211	1	N	Spare1 calib2	-32768	+32767
V1212	1	N	Spare1 calib3	-32768	+32767
V1213	1	N	Spare1 calib4	-32768	+32767
V1214	1	N	Spare1 calib5	-32768	+32767
V1215	1	N	Spare1 calib6	-32768	+32767
V1216	1	N	Spare1 calib7	-32768	+32767
V1217	1	N	Spare1 calib8	-32768	+32767
V1218	1	N	Spare1 calib9	-32768	+32767
V1219	1	N	Spare1 calib10	-32768	+32767
V1220	1	N	Spare1 calib11	-32768	+32767
V1221	0	N	Spare1 res1	+00000	+10000
V1222	1000	N	Spare1 res2	+00000	+65535
V1223	2000	N	Spare1 res3	+00000	+65535
V1224	3000	N	Spare1 res4	+00000	+65535
V1225	4000	N	Spare1 res5	+00000	+65535
V1226	5000	N	Spare1 res6	+00000	+65535
V1227	6000	N	Spare1 res7	+00000	+65535
V1228	7000	N	Spare1 res8	+00000	+65535
V1229	8000	N	Spare1 res9	+00000	+65535
V1230	9000	N	Spare1 res10	+00000	+65535
V1231	10000	N	Spare1 res11	+00000	+10000

For « Normally closed » or « normally opened » inputs wiring will be similar, only the software requires modification. Then enter these equations to switch to virtual input:

```
@*****;
@analog input to DI/spare 1 ;
@*****;
@E0031 analog input spare 1;
@E2283 virtual input 1 ;
@*****;
E2283:= E0031 ;
```

Calibration table is similar for a normally opened input; you need only change the equations:

```
@*****;
@ Analog input in numeric/spare 1 ;
@*****;
@E0031 analog input spare 1;
@E2283 virtual input 1;
@*****;
E2283:= !E0031 ;
```

13 PROTECTIONS

Protections are triggered by different events (digital inputs, and logic sequences). They take action to protect a process, engine or alternator.

When configured, they can take the actions listed hereunder.

13.1 DISABLE

This gives no effect.

13.2 GENERATOR ELECTRICAL FAULT

This action triggers a “Generator electrical fault”. Protection will open genset breaker and try to re-synchronize again. Number of attempts can be configured.

13.3 MAINS ELECTRICAL FAULT

This action triggers a “Mains electrical fault”. Protection will open mains breaker and will start the generator and take the load if the parameter [E1841] start on fault is set to 1 (“Configuration/Mains/Bus/mains electrical fault” menu).

The mains back is validated by the timer [E1085] (“Configuration/Timers/Mains” menu).

In change-over mode, the time between the emergency open and the normal close is managed by the timer [E1459] (“Configuration/Timers/Mains” menu).

In no break change-over mode, the load transfer time between the normal towards the emergency (and conversely) are defined by the timers [E1151] load ramp and [E1152] unload ramp (“Configuration/Generator” menu)

13.4 ALARM

This action triggers an “Alarm”.

13.5 FAULT (SOFT SHUT DOWN)

This action triggers a “Soft shutdown”. Genset breaker will open allowing the engine to cool down off load for the duration of the cool down timer. The engine is then stopped.

13.6 SECURITY (HARD SHUTDOWN)

This action triggers a “Hard shutdown”. Genset breaker will open and engine will be stopped immediately without cooling down.

13.7 DROOP

The kW load sharing is not done by the CAN bus but in droop. This protection is used when a default on inter-units CAN bus is detected. (See §17.2.1 for more details)

13.8 HELP + FAULT (SOFT SHUT DOWN)

This action triggers a “Soft shutdown” with “Help call”. Before the soft shutdown sequence, GENSYS 2.0 will call another genset onto load via the inter-GENSYS CAN bus. When the helping set is connected to the busbar (and not before!) GENSYS 2.0 will open the genset breaker, allowing the engine to cool down off load, for the duration of the cool down timer. The engine is then stopped.

13.9 HELP + GEN. ELECTRICAL FAULT

This action triggers a “Generator electrical fault” with “Help call”. Breaker(s) to be opened can be configured (genset breaker or mains breaker).

Before opening the corresponding breaker, GENSYS 2.0 will call another genset onto load via the inter-GENSYS CAN bus. When the helping set is connected to the busbar (and not before!) GENSYS 2.0 will open the corresponding breaker and try to synchronize again. The number of attempts can be configured.

13.10 POTENTIAL ALARMS/FAULTS LIST

The potential alarms/faults list is described in the table below.

- Variable field : parameter number corresponding to the alarm/fault. If this variable is equal to 1, it means that the Alarm/Fault is active.
- Potential Alarm/Fault field : corresponding to Alarm/Fault label. This text will be display in the Alarm/fault pages.
- Alarm/Fault control field : this variable allows to define the protection type to associate to the Alarm/Fault.

This list can also be download from the web site in the menu “System/GENSYS 2.0 -> PC file/Alarms/Faults summary”.

Variable	Potential Alarm/Fault	Description	Alarm/Fault control
E0130	CAN bus fault	A communication problem occurs on the inter-unit CAN bus.	E1259
E2005	Emergency stop	Digital input « Emergency stop » is open.	Hard shutdown
E2097	Generator +f	Generator is in over frequency	E1024
E2101	Generator -f	Generator is in under frequency	E1027
E2105	Generator -U	Generator is in under voltage	E1030
E2109	Generator +U	Generator is in over voltage	E1033
E2113	Min kVAR	Generator reached a minimum of kVAR.	E1036
E2117	Max kVAR	Generator reached a maximum of kVAR.	E1039
E2121	-kW	Generator is in reverse kW.	E1042
E2125	-kVAR	Generator is in reverse kVAR.	E1045
E2129	Min kW	Generator reached a minimum of kW.	E1048
E2133	Max kW	Generator reached a minimum of kW.	E1051
E2137	Max I	Generator is in over current	E1054
E2141	Max In	Generator is in over neutral current	E1057
E2145	Mains -f	Mains is in under frequency.	E1060
E2149	Mains +f	Mains is in over frequency.	E1063
E2153	Mains -U	Mains is in under voltage.	E1066
E2157	Mains +U	Mains is in over voltage.	E1069
E2170	Vector jump	A vector jump fault has been detected.	E1071
E2171	df/dt	A ROCOF fault has been detected.	E1073
E2530	MA min kVAR	Mains reached a minimum of kVAR.	E1410
E2534	MA max kVAR	Mains reached a maximum of kVAR.	E1413
E2538	MA -kW	Mains is in reverse kW.	E1416
E2542	MA -kVAR	Mains is in reverse kVAR.	E1419

Variable	Potential Alarm/Fault	Description	Alarm/Fault control	
E2546	MA min kW	Mains reached a minimum of kW.	E1422	
E2550	MA max kW	Mains reached a minimum of kW.	E1425	
E2172	Over speed	Engine is in over speed	E1162	
E2176	Under speed	Engine is in under speed	E1165	
E2180	Min oil press.	The oil pressure reached the minimum threshold (Analog input F8-F9).	E1168	
E2184	Max water temp	The water temperature reached the maximum threshold (Analog input F6-F7).	E1171	
E2188	Min batt. volt	Battery is in under voltage.	E1174	
E2274	Max batt. volt	Battery is in over voltage.	E1098	
E2347	Oil pres fault	An oil pressure fault has been detected. (Digital input set as Oil pressure fault).	Hard shutdown	
E2004	Water Temp	A water temperature fault has been detected (digital input set as Water temperature fault)	Hard shutdown	
E2804	Spare Input J4	If the digital input is used as a protection, an Alarm/Fault will be activated.	E1996	
E2805	Spare Input J5		E1997	
E2806	Spare Input J6		E1267	
E2807	Spare Input J7		E1268	
E2808	Spare Input J8		E1269	
E2809	Spare Input J9		E1270	
E2810	Spare Input J10		E1271	
E2811	Spare Input J11		E1272	
E2812	Spare Input J12		E1273	
E2813	Spare Input J13		E1274	
E2814	Spare Input J14		E1275	
E2815	Spare Input J15		E1276	
E2283	Virtual in 01		If the virtual input is used as a protection, an Alarm/Fault will be activated.	E1328
E2284	Virtual in 02			E1329
E2285	Virtual in 03			E1330
E2286	Virtual in 04	E1331		
E2287	Virtual in 05	E1332		
E2288	Virtual in 06	E1333		
E2289	Virtual in 07	E1334		
E2290	Virtual in 08	E1335		
E2291	Virtual in 09	E1336		
E2292	Virtual in 10	E1337		
E2293	Virtual in 11	E1368		
E2294	Virtual in 12	E1369		
E2295	Virtual in 13	E1370		
E2296	Virtual in 14	E1371		
E2297	Virtual in 15	E1372		
E2298	Virtual in 16	E1373		
E2299	Virtual in 17	E1374		
E2300	Virtual in 18	E1375		
E2301	Virtual in 19	E1376		
E2302	Virtual in 20	E1377		
E2565	Virtual in 21	E1680		
E2566	Virtual in 22	E1681		

Variable	Potential Alarm/Fault	Description	Alarm/Fault control
E2567	Virtual in 23		E1682
E2568	Virtual in 24		E1683
E2569	Virtual in 25		E1684
E2570	Virtual in 26		E1685
E2571	Virtual in 27		E1686
E2572	Virtual in 28		E1687
E2573	Virtual in 29		E1688
E2574	Virtual in 30		E1689
E2575	Virtual in 31		E1690
E2576	Virtual in 32		E1691
E2577	Virtual in 33		E1692
E2578	Virtual in 34		E1693
E2579	Virtual in 35		E1694
E2580	Virtual in 36		E1695
E2581	Virtual in 37		E1696
E2582	Virtual in 38		E1697
E2583	Virtual in 39		E1698
E2584	Virtual in 40	E1699	
E2327	Sensor lost	A fault « sensor lost » is triggered if the speed is null and the engine started.	Hard shutdown
E2363	Breaker fault	A fault is triggered if the breaker controls (Mains or generator) don't work correctly.	Hard shutdown
E2690	Breaker alarm	An alarm is triggered if the breaker controls (Mains or generator) don't work correctly.	Alarm
E2364	Fail to stop	A fault is triggered when the engine doesn't stop correctly.	Hard shutdown
E2365	Not ready	A fault is triggered if the requirements to start the engine are not observed. (Water temperature and oil prelubrication) ⁽¹⁾	Hard shutdown
E2366	Fail to start	A fault is triggered if the motor didn't succeed to start.	Hard shutdown
E2367	Fail to synch	The unit could not synchronize to Mains/Bus.	E1928
E5049	Phase measure	Phase fault between the generator voltages.	E4040
E2556	Min/Max meas1	Threshold protection (minimum or maximum) of the analog input 1 (F1-F2)	E1182
E2560	Min/Max meas2	Threshold protection (minimum or maximum) of the analog input 2 (F3-F4)	E1186
E2304	Meter 1 (h)	Alarm is raised when a maintenance must be done (See §14.16)	Alarm
E2305	Meter 2 (h)		
E2306	Meter 3 (h)		
E2307	Meter 4(h)		
E2308	Meter 5 (h)		
E2309	Meter 1 (d)		
E2310	Meter 2 (h)		
E2311	Meter 3 (h)		
E2312	Meter 4 (h)		
E2313	Meter 5 (h)		
E2511	CANopen fault	A fault is triggered if a CANopen bus error is	Alarm

Variable	Potential Alarm/Fault	Description	Alarm/Fault control
		detected.	
E0851	CAN J1939 Err.	A J1939 CAN bus error is detected.	E4080
E0332	Overspeed	Overspeed detected by J1939-MTU.	E1857
E0339	Low Oil P	Low oil pressure detected by J1939-MTU.	E1858
E0343	High Cool T	High water temperature detected by J1939-MTU	E1859
E0355	Very Low Oil P	Very low oil pressure detected by J1939-MTU.	E1860
E0356	Very Hi Cool T	Very high water temperature detected by J1939-MTU	E1861
E0358	Hi Overspeed	High overspeed detected by J1939-MTU.	E1862
E0359	Malfunct lamp	Detected by J1939-MTU.	E1863
E0363	Protect lamp	Detected by J1939-MTU.	E1864
E0386	Amber lamp	Detected by J1939-MTU.	E1865
E0403	Red lamp	Detected by J1939-MTU.	E1866
E0404	Option4Var075	Protection used by MTU-MDEC (see §17.3.3)	E1867
E0407	Option4Var078		E1868
E0414	Trame RX 1/4		E1869
E0422	Trame RX 2/2		E1870
E0426	Trame RX 2/6		E1871
E2729	Trip alarm		Overload alarm used for non-essential consumer (see §15.2)
E0820	Unavailable	MASTER 2.0 only: Indicates that the power plant is not available. GENSYS 2.0 units may be in manual mode or in fault.	Hard shutdown
E5030 to E5045 E5071 to E5086	Alarm mod. 01 to Alarm mod. 32	MASTER 2.0 only: Indicates that group number 1 to 32 is in fault.	Alarm
E2804	Spare input J4	If the digital input is used as a protection, an Alarm/Fault will be activated.	E1996
E2805	Spare input J5		E1997
E2915	Uneven kW	In load sharing mode, indicates that actual kW measure of the generating set is far from the average of the other groups.	E4111
E2918	Uneven kVAR	In load sharing mode, indicates that actual kVAR measure of the generating set is far from the average of the other groups.	E4114

TABLE 34 - POTENTIAL ALARM/FAULT LIST

(1) For an external start module, the alarm/fault [E2365] Engine not ready correspond to a lost of GE Ok signal [E2515].

14 ADDITIONAL FUNCTIONS

14.1 LOAD SHARING USING INTEGRAL (DE-DROOPING)

14.1.1 INTRODUCTION

This function is for generators in island mode (no mains), it allows perfect load sharing at the right frequency even if the generators are not the same.

When several generators are on the bus bar, one takes a central role with a fixed frequency of 50Hz. The other generators determine load sharing using an integral so that each one has a perfect share.

The set point of the central frequency is the parameter [E1080] (or [E1081] if selected).

When the GENSYS 2.0 starts, one genset is elected to be the master (the first one on the bus). The master determines the central frequency and load sharing is without an integral. The other gensets determine the load sharing with an integral, but without using the central frequency.

When you have several generators paralleled with mains, the central frequency is disabled.

14.1.2 PROCEDURE

1. In **[Manu]** mode, using **[+]** and **[-]**, adjust the speed control output (G9-G11) to obtain the desired frequency +/-2Hz for each genset.
2. Test that load sharing is working properly (default values inhibit the integral).
3. Activation of central frequency on first genset:
On the front panel of the GENSYS 2.0 (or on the PC)

In the menu: « Configuration/Modification by variable n° », set

- [E1476] on 2,
- [E1900] on 5: Proportional kW load sharing
- [E1901] on 2: Integral kW load sharing

Access, in level 2, to menu: « Configuration /Control loops/kW control» and set the following parameters ::

kW sharing loop

-G = 50 % [E1102]

Hz loop

-G = 25% [E1902]

4. Adjust genset speed to give 49Hz using the speed governor (GENSYS 2.0 in manual mode without load).
5. Switch to **[Test]** mode. When the breaker is closed frequency should return to 50.00Hz within 5 seconds.
6. Adjust the Hz central gain [E1902] to adjust the time if needed.
7. Repeat step 5 for all gensets.
8. Test the load sharing by changing the nominal frequency of one generator to 49Hz.

Bus frequency should remain at 50Hz and kW load sharing within 2% of that desired. The stability of load sharing is adjusted with kW sharing GPI / I [E1901]

Notes:

[E1902] = stability of de-drooping (only activated in the master GENSYS 2.0). Adjust to recover 1Hz within 5 sec.

[E1476] = 0 ⇔ Inhibition of central frequency.

[E1476] = with a high value, response time will be slower (recommended default value =2)

[E1901] = Load sharing integral, is only active on the slave GENSYS 2.0 units.

[E1102] = Global gain of load sharing is obtained by multiplying the PI and the central Hz gain.

[E2739] = 1 ⇔ I am the master (I control the frequency).

[E2739] = 0 ⇔ I am a slave (I share load using the integral)

14.1.3 GCR SYNCHRONIZATION & MAINS PARALLELING



When using the central frequency (de-drooping) function and paralleling with the mains using an analogue bus, the central frequency has to be inhibited during synchronization. The following equations should be added in level 1 or 2 if the synchronization bus is used (terminal 42 of GCR, terminals G1 & G3 of GENSYS 2.0):

```
@ *****;
@ digital input 1(E2006) is closed during mains synchronization;
@ mains breaker feedback is connected to terminal J1 ;
@ Don't forget to allow parameter E1476 and E1020 to be ;
@ modifiable by modbus and equations ;
@ *****;
TEST (E2006 EQ 1) AND (E2000 EQ 0) EQ 1 THEN
  BLOC
    E1476:=0;
    E1020:=20000
  BEND
ELSE
  BLOC
    E1476:=2;
    E1020:=0
  BEND
TEND;
```

14.1.4 INTEGRAL INHIBITION

To disable this type of load sharing and return to the old type, apply the “Disable value” from the table below.

The variables involved in the new type of load sharing are:

Variable number	Label	Description	Default value	Disable value
V1102	Load sharing G	Parameter to set the Global gain.	50	50
V1900	Load sharing P	Parameter to set the Proportional gain.	5	1
V1901	Load sharing I	Parameter to set the Integral gain.	2	0
V1902	Hz centre gain	Parameter to control the central frequency, acting as a frequency standard	25	0
V1476	XXXXXX		2	0
V2739	Master gen. Nb	If 1 this GENSYS 2.0 is the master.	X	X

TABLE 35 -INTEGRAL INHIBITION



Warning:

When the CAN bus is not used, you have to disable load sharing (see table above). In the case of a CAN bus failure where [E1259] is not set at 6 (load sharing in droop disabled), you also have to disable load sharing.

14.2 OPERATOR CONTROLLED RETURN TO MAINS

Normal operation: In the case of mains failure, the engine starts and takes the load. When the mains voltage returns, the engine resynchronizes with the mains and automatically gives back the load.

The “Operator controlled return to mains” special function (set with the parameter [E1620] = 1) allows the operator to control the moment the engine will return the load to the mains.

To do this, a digital input of the GENSYS 2.0 must be set as “Manual main back” [E2850]. The unit will wait the synchronization order provide by the digital input before re-synchronizing the engine to the mains.

14.3 MAINS ELECTRICAL FAULT

Mains electrical fault management: dedicated parameters and default values

Parameter	Default value	Description
E1841 ⁽¹⁾	Yes	Indicates if the generating set should be started on Mains electrical fault appearance.
E1846 ⁽¹⁾	Mains	Indicates which circuit breaker should be opened on Mains electrical fault appearance. Choose between Mains, Generating set or Both.
E1840 ⁽²⁾	0.0s	Delay before start sequence begins on Mains electrical fault appearance.
E1842 ⁽²⁾	60.0s	No load delay. Indicates the time to let the engine run without load when generating set circuit breaker is opened. If set to 0, engine will never stop.

TABLE 36 - MAINS ELECTRICAL FAULT

- (1) available in « Configuration/Mains/Bus/Mains electrical fault» menu.
- (2) modification by variable number.

Chronogram below shows the behavior when using change over mode.

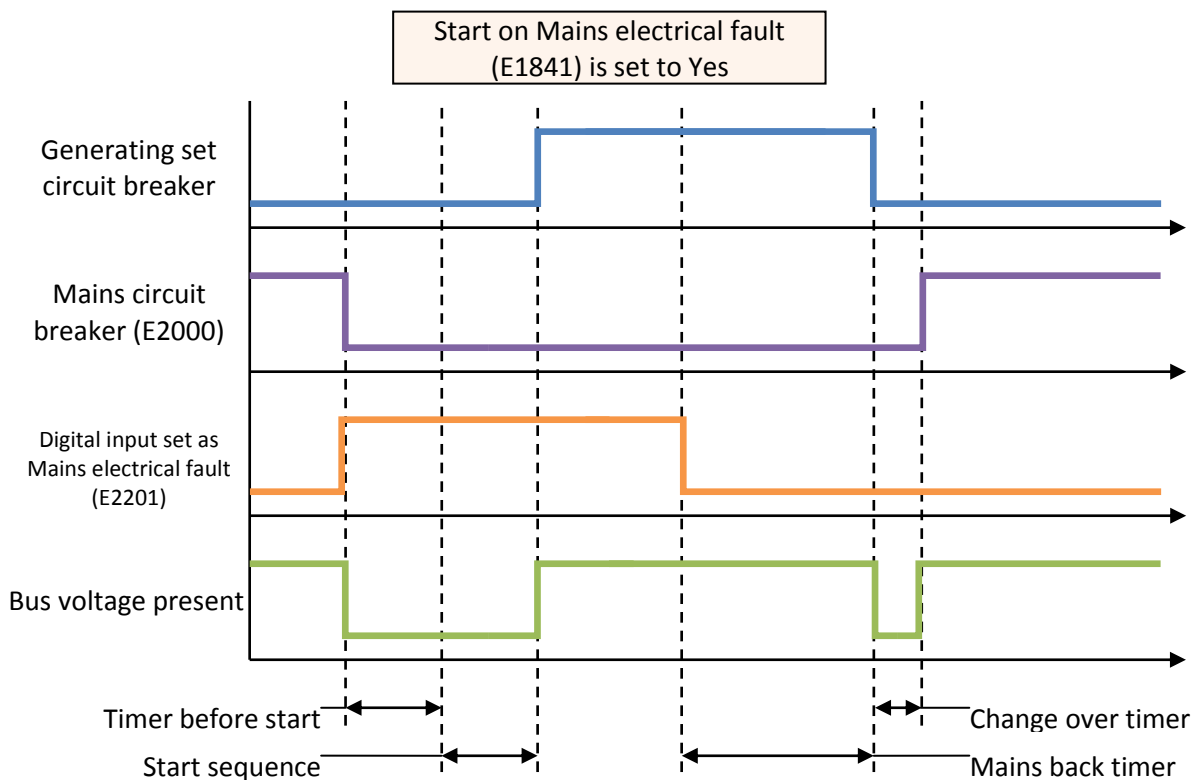

FIGURE 56 - CHANGE OVER WITH ONE DIGITAL INPUT SETUP AS "MAINS ELECTRICAL FAULT"

Chronogram below shows the behavior when using Mains permanent paralleling mode.

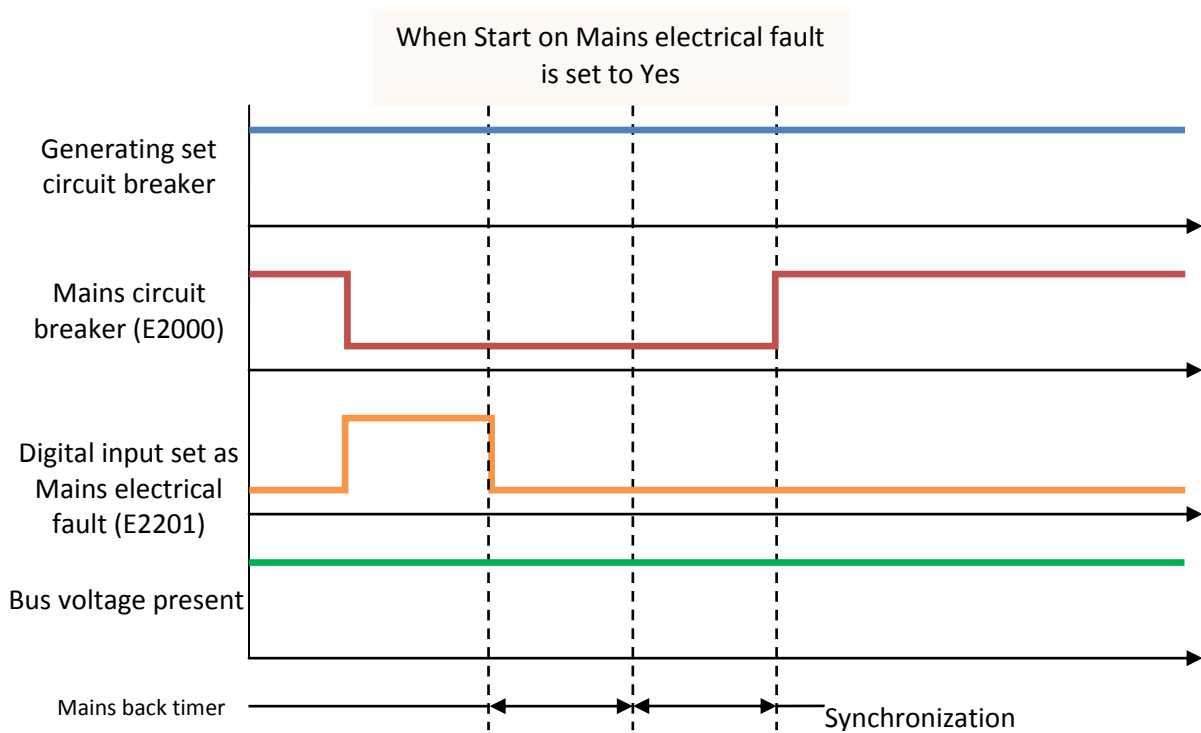

FIGURE 57 - PERMANENT MAINS PARALLELING WITH ONE DIGITAL INPUT SETUP AS "MAINS ELECTRICAL FAULT"



NOTE:

Never use "No start on fault" in conjunction with "open mains on fault" in permanent mode or no break change over mode.

Always use "No start on fault" when "generator breaker" or "both breakers" to open is selected.

14.4 GENERATOR ELECTRICAL FAULT

In case of a generator electrical fault, the generator breaker is opened and the alternator is de-excited (if wired) during a certain time [E1265]. If the fault is still present after this time has elapsed, a hard shutdown occurs. Otherwise GENSYS 2.0 will try to re-synchronize. Associated parameters are listed in the table below.

Parameter	Default value	Description
E1843 ⁽¹⁾	30.0s	Time to wait after a generator electrical fault disappears before trying to synchronize.
E1844 ⁽¹⁾	2	Attempts to re-synchronize when a generator electrical fault appears and disappears.

TABLE 37 - GENERATOR ELECTRICAL FAULT

(1) Available in « Configuration/Generator 2/2/GE electrical fault » menu.

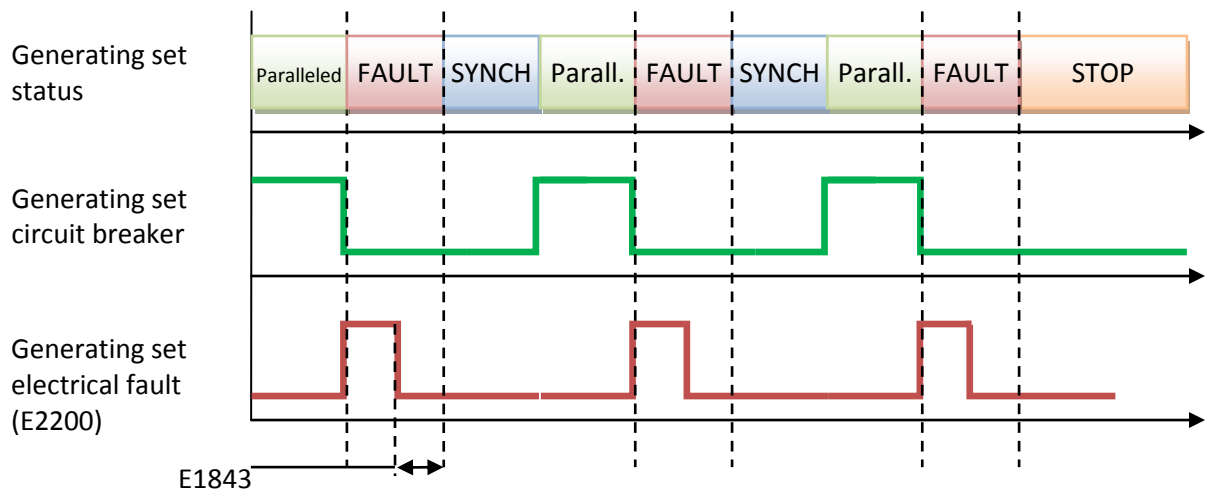

FIGURE 58 - PERMANENT MAINS PARALLELING AND GENERATOR ELECTRICAL FAULT

14.5 GENSYS 2.0 WITH EXTERNAL AUTOMATIC START MODULE

14.5.1 OVERVIEW

This chapter describes how to interface GENSYS 2.0 with an engine featuring its own automatic start module. In this case GENSYS 2.0 internal start sequence must be inhibited. The following diagram shows the main functions of each device:

Note: starting from firmware v4.00, GENSYS 2.0 features an easy configuration whereas older firmware versions require the use custom equation(s) (In this case, contact your local distributor or the CRE Technology technical support).

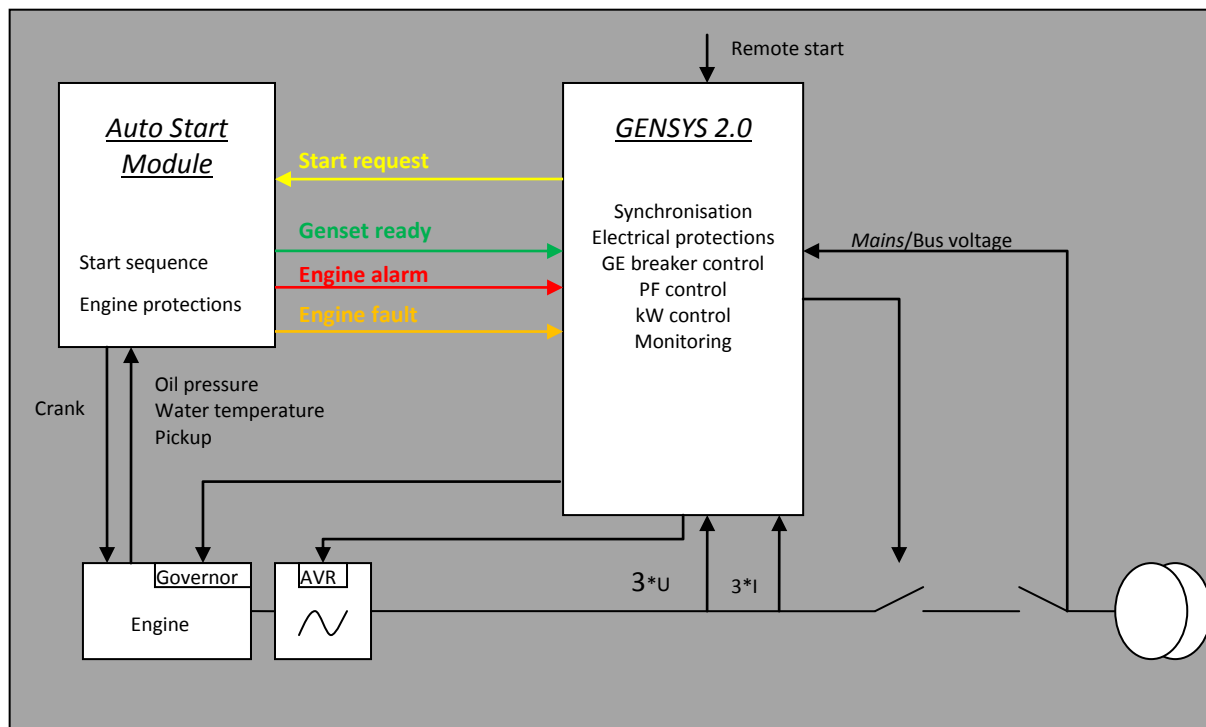

FIGURE 59 - WIRING GENSYS 2.0 AND AUTO START MODULE

Signal description	Direction	Auto Start Module (ASM)	GENSYS 2.0
Start request (Fuel)	GENSYS 2.0->ASM	Remote start input	A1
Genset ready (optionnal) ⁽¹⁾	ASM->GENSYS 2.0	Digital output	J15 ⁽²⁾
Engine Alarm	ASM->GENSYS 2.0	Digital output	J7 ⁽²⁾
Engine Fault	ASM->GENSYS 2.0	Digital output	J6 ⁽²⁾

TABLE 38 - WIRING GENSYS 2.0 AND AUTO START MODULE

- (1) See below if your external start module doesn't have a « Genset Ready » output.
 (2) This is only an example. Other GENSYS 2.0 inputs can be used.

Note: The GENSYS 2.0 doesn't need the oil pressure and water temperature digital inputs.

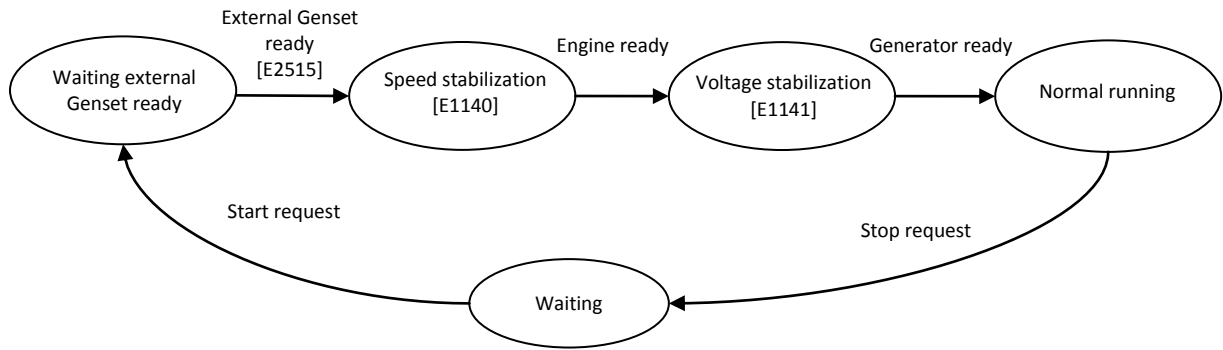

FIGURE 60 - EXTERNAL START SEQUENCE

14.5.2 CONFIGURATION

1. It is first needed to inhibit GENSYS 2.0 internal start sequence by selecting “External Auto start module” (E1608= 1) in menu “configuration/Engine”.
2. **Case 1:** external start module features a “Generating set ready” logic output.

Configure a GENSYS 2.0 logic input as “External GE OK” (Menu “Configuration/Inputs/Digital inputs”) – Input J15 in this example.

Case 2: external start module doesn’t feature any “Generating set ready” logic output.

GENSYS 2.0 will have to wait for the lower voltage [E1028] and the lower engine speed [E1163] are reached to go in speed stabilization [E1140] then in voltage stabilization [E1141] to consider the generating set is ready.

3. The Fuel relay output is directly connected to the start request input of the ASM.
4. Set up a GENSYS 2.0 logic input as “External alarm” using menu “Configuration/Inputs/Digital inputs” (Logic input J7 in this example) and connect it to the “Engine alarm” signal of the external start module.
5. Set up a GENSYS 2.0 logic input as “Ext. security (hard shutdown)” (immediate engine stop) or “Ext. fault (soft shutdown)” (stop after cool down sequence) using menu “Configuration/Inputs/Digital inputs” (Logic input J6 in this example) and connect it to the “Engine fault” signal of the external start module.

Note: if GENSYS 2.0 doesn’t receive any “External GE OK” signal, then parameter [E1633] will be used as delay before triggering a no start fault.

14.6 REMOTE START UPON EXTERNAL PULSE



To set the GENSYS 2.0 to start upon an external pulse input, 2 solutions can be used:

- Use a relay
- Set an external input

This variable E2514 (Virtual Start) must be maintained at « 1 » after the first rising edge and go to 0 after the second rising edge. Example is for the J15 input:

```
@ WARNING: if section empty or missing, existing equations will be lost;
PROG 1
BLOC

    @@@@ PULSE ON REMOTE START FROM EXTERNAL @@@@;
    @ E2585 = Value of the E2815 with one cycle less to detect a pulse;
    @ ( E2815 EQ 1) AND (E2585 EQ 0) Detection of a top pulse;
    @@@@@@@@@@@@@@@@@@@@@@@@@@@@@@@@@@@@@@@@@@@@@@@@@@@@@@@@@@@@@;
    E2585:= E2815;
    E2514:=((E2514 OR ((E2815 EQ 1) AND (E2585 EQ 0))) AND ((E2514 AND ((E2815 EQ 1) AND
(E2585 EQ 0))) EQ 0))
BEND
.
```

Do not forget to set the input. GENSYS 2.0 must be informed that J15 (in this example) is used by a custom equation:

```
V1276 1 N DIJ15 function +00000 +02999
```

Here the variable E2585 detects a rising edge on E2815.

The cycle or the variable E2815 goes from 0 to 1. The variable E2585 stays at 0 a cycle longer in order to see E2815 =1 and detect the rising edge.

You can also detect the falling edge by changing the equation:

```
(E2815 EQ 1) AND (E2585 EQ 0) to (E2815 EQ 0) AND (E2585 EQ 1).
```

14.7 SAFETY INHIBITIONS

14.7.1 OBJECTIVE



Safety inhibitions are mandatory on certain types of application, particularly in safety generators used in public spaces (norm NF E 37-312).

The aim is to inhibit the oil pressure and water temperature safeties on the GENSYS 2.0. Thus, in the case of a fault, the generator remains in operation. Other protections (over speed, overload, etc...) are still active if set.

14.7.2 CONFIGURATION

1/ Hardware

Contacts for oil pressure and water temperature are no longer connected to J4 and J5 but to spare configurable inputs.

In this example, the oil pressure and water temperature contacts are on J13 and J14.

2/ Software

The following equations must be downloaded to level 1 or 2 (as described in §17.7.3 or §19.4.7):

BLOC

```
@*****;  
@ Oil pressure and water temp Inhibition      ;  
@*****;  
@E2811 Logical Input J11 GENSYS 2.0 inhibit security      ;  
@E2812 spare input 8 J12 oil pressure      ;  
@E2813 spare input 9 J13 is water temperature      ;  
@E1273 fct spare input J12      ;  
@E1274 fct spare input J13      ;  
@E0033 speed      ;  
@E1712 user param: start speed      ;  
@E1714 user param: stop speed      ;  
@E1456 Oil pressure sign      ;  
@E1457 Water temp sign      ;  
@E2283 Virtual input 1 alarms inhibition      ;  
@*****;
```

TEST E2011 EQ 1 THEN

BLOC

E1457:=0;

E2283:=1;

E1274:=2208;

TEST E0033 GT E1712 THEN E1456:=0

ELIF E0033 LE E1714 THEN E1456:=1

TEND;

E1273:=2208

BEND

ELSE

BLOC

E1456:=E2812;

E1457:=!E2813;

E2283:=0;

E1273:=1;

E1274:=1

BEND

TEND

BEND

14.8 USE OF BSM II WITH GENSY 2.0



When you have a lot of analogue values to monitor, BSM II can be connected to GENSY 2.0 to log measurements and process data efficiently. This chapter will explain this type of configuration.

14.8.1 SCHEMATIC

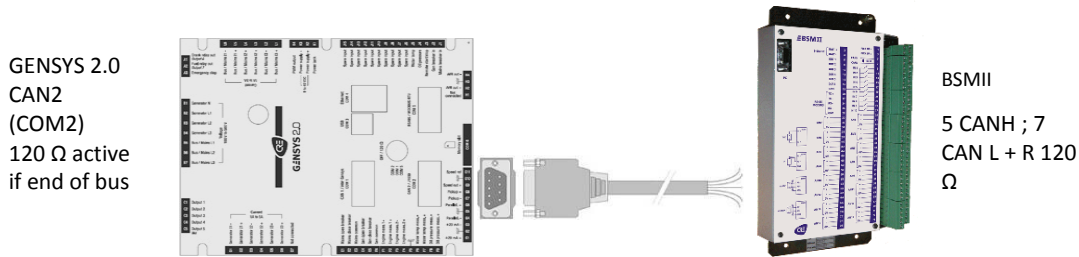

FIGURE 61 - WIRING GENSY 2.0 TO BSM II

Notes:

See §22.3 in order to choose the cable that fit your application.

If BSM II is at the end of the CAN bus, add one 120 Ω resistor in parallel with terminals 5 and 7.

14.8.2 CONFIGURATION

The communication between GENSY 2.0 and BSM II uses a CANopen protocol. BSM II is a slave unit and GENSY 2.0 a master unit.

GENSY 2.0 can be connected to several devices via its COM2: BSM II (Max 2), Wago[©] coupler (Max 32).

Only one of the two BSM II must be set to log data from GENSY 2.0 (limited by the number of messages sent from GENSY 2.0).

14.8.3 PROCEDURE EXAMPLE

This example allows you to log the most significant variables of your application when an alarm occurs.

See also the application note “A43Z090100A” to configure the BSM II logging.

Download the text file (level 1 equation) “Z090211a_1.txt” to the GENSY 2.0 as described in §17.7.3 or §19.4.7.

Download the text file (level 1 equation) “A43Z090100a_1.txt” to the BSM II.

Archiving of data begins immediately.

Variables are stored in the BSM II at the rate of 1 sample per second when an alarm occurs:

- ❖ 5 samples before the alarm
- ❖ 1 sample when alarm occurs
- ❖ 5 samples after the alarm

See the application note “A43Z090100A” to retrieve archives from the BSM II.

The table below list the transmitted variables:

AO	Var.	AO	Var.	AO	Var.	AO	Var.	AO	Var.	AO	Var.
1	Alarm E0516	5	kW GE E0018	9	V1 E0000	13	I2 E0007	17	kW3 E0011	21	Free
2	kW mains E0036	6	Hz GE E0020	10	V2 E0001	14	I3 E0008	18	PwrMngt Status E2071	22	Free
3	Hz mains E0023	7	cosφ GE E0021	11	V3 E0002	15	kW1 E0009	19	Engine Status E2057	23	Free
4	U13 mains E0022	8	Sum Digital	12	I1 E0006	16	kW2 E0010	20	free	24	Free

Sum Digital = each bit of this parameter represents a logic variable.

Bit0 = breaker in mains (E2000)

Bit1 = breaker in GE (E2001)

Bit2 → Bit14: free

Bit15: forbidden (this bit gives the result a bad negative value)

Note: With this configuration, the BSM II node ID is equal to 1. Make sure that no other device on the CAN bus has the same node ID.

14.8.4 CUSTOM PROCEDURE

This procedure shows you how to customize equations to send your own variables to the BSM II.

See also the application note “A43Z090101A” to customize the BSM II archiving.

Download the text file (level 1 equation) “Z090211a_1.txt” to the GENSYS 2.0 as described in §17.7.3 or §19.4.7.

Download the text file (level 1 equation) “A43Z090100a_1.txt” to the BSM II.

1/ Change the Node ID of BSM II

See BSM II user's manual to choose the node ID in the BSM II.

Then change this node ID (Output address) in the settings of the GENSYS 2.0 (default ID equal 1) via the **CRE Config** software.

2/ Delete message

If you do not need to send all variables set in default equations, you can delete output messages.

To do this, set “Output data type” to Unused and “Output address” to 0 via **CRE Config** software.

3/ Add message

Each message sends a maximum of 4 Analogue values to BSM II.

By using the **CRE Config** software :

- Set "Output address " to the correct Node ID of the BSM II.
- Set "Output Data Type" to Analog
- Set "Number of Outputs" (Max 4)
- Add equation described below

4/ Customize the variables sent to BSM II

All variables are transferred as analogue outputs from GENSYS 2.0 to BSM II.

Analogue output	GENSYS 2.0 Variable
AO1 → AO8	E2432 → E2439
AO9 → AO16	E2682 → E2689
AO17 → AO32	E2708 → E2723

All variables are transferred as analogue inputs from BSM II to GENSYS 2.0.

Analogue input	GENSYS 2.0 Variable
AI1 → AI44	E0285 → E0328

Transfer a variable from GENSYS 2.0 to BSM II

To do this, write the equation below in level 1.

Example:

This example copies the KW measurement (E0018) to Analog Output 1 (E2432).

```
@ Allocate AO1 (E2432) to the measure of kW (E0018)
E2432:=E0018;
```

Transfer several digital variables (max 15) via one analogue output.

Each bit of the AO is equal to a digital variable.

Example:

```
@ allocate AO8 to digital outputs
@Breaker mains(b6) + 6 Digital Outputs(DO6=b5 -> DO1=b0);
E2439:= 0;
E2439:= X2439 + (64*E2000) + (32*E2445) + (16*E2444) + (8*E2443) + (4*E2442) + (2*E2441) + E2440;
```

Note: In the PLC equation, variables are considered as signed integers. This means that bit 31 is the sign and cannot be used.

14.9 GENSYS 2.0 WITH TEM COMPACT



This chapter describes how to interface the GENSYS 2.0 with the TEM compact from Deutz Engines.

The association of the TEM and the GENSYS 2.0 is an excellent solution to parallel a generator set with a Deutz Engine prime mover.

Some functions are redundant: the kW regulation and the start sequence. The following diagram shows the main function of each device:

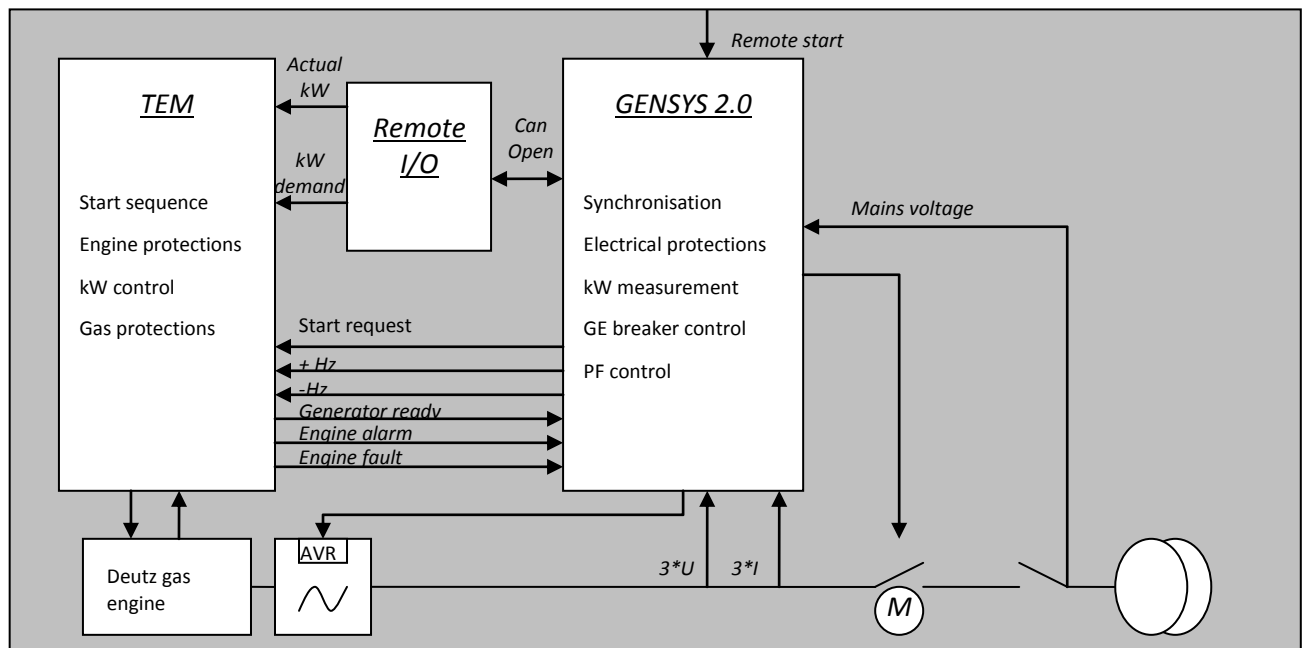

FIGURE 62 - WIRING GENSYS 2.0 ↔ TEM

Signal description	Remark	Direction	TEM Compact	GENSYS 2.0 / CANopen module
Start request	used only if the kW set point is in the TEM	GENSYS 2.0->TEM	X141-4 X142-4	C5
kW demand 0-20mA	Used to start/stop and to fix the kW set point.	GENSYS 2.0/CANopen ->TEM		CANopen module output 2
Genset ready		TEM->GENSYS 2.0	X31-5 X31-6	J15
TEM Alarm	Relay	TEM->GENSYS 2.0	X31-1 X31-2	J7
TEM Fault	Relay	TEM->GENSYS 2.0	X31-3 X31-4	J6
+ Hz	Digital signal	GENSYS 2.0->TEM	X141-6 X142-6	C1
- Hz	Digital signal	GENSYS 2.0->TEM	X141-7 X142-7	C2
Pickup				G7 – G8

Signal description	Remark	Direction	TEM Compact	GENSYS 2.0 / CANopen module
Analogue AVR signal	AVR=MX321	GENSYS 2.0->AVR		H2 – H4
Actual kW 0-20mA		GENSYS 2.0 -> TEM		CANopen module output 1

TABLE 39 - WIRING GENSYS 2.0 ↔ TEM

Note: This wiring diagram is only an example; you can use a different wiring setup if necessary.

To start an application, contact your local distributor or CRE Technology support.

14.10 G59 NORM (ACCESS LEVEL -1)

Access to this specific feature is done using a special procedure:

1. - First connect with password level 1.
 - Go in menu “Configuration/Modification by variable n°”
 - Set parameter [E1610] on 2
2. - Go back to the login page (press 3 times on **[ESC]**).
 - Enter password « **CustMenu** ».
 - Now you can access to the special features concerning G59

G59 is a protection norm widely used in the UK. You can set and lock the following protections:

- ❖ Mains Under / Over frequency.
- ❖ Mains Under / Over voltage.
- ❖ Vector surge.
- ❖ ROCOF (df/dt).

When the protections are locked, thresholds, timers and controls are also locked.

14.11 SCADA

GENSYS 2.0 communication uses industrial standards. This product is versatile, and can be used with Modbus, for example to be controlled by a SCADA system.

CRE Technology offers different solutions for such applications (remote display, remote control, event and alarm management ...). Contact us for more information.

14.12 HOW TO SET A GPID

14.12.1 PRINCIPLE

A GPID allows the control of any system in a simple way. Figure 51 shows a typical GPID.

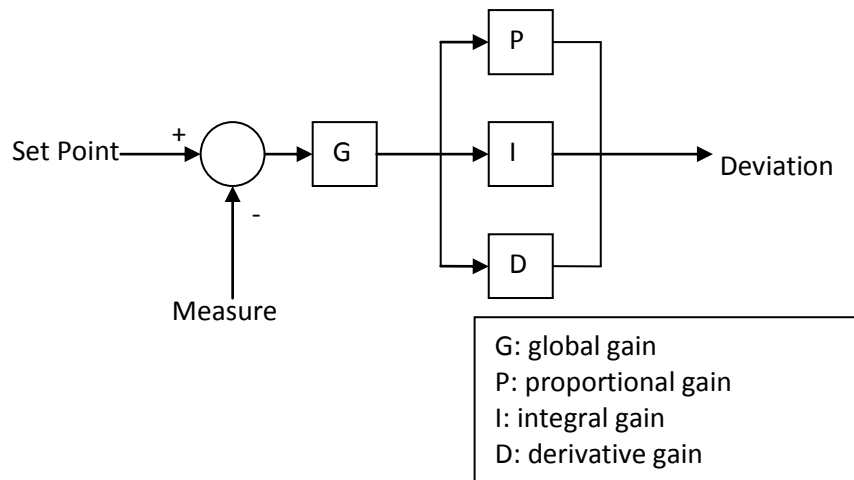

FIGURE 63 - TYPICAL GPID CONTROLLER

The G parameter acts as sensitivity adjustment for the other parameters.

The P parameter adjusts the rise time (time needed for the system to reach its set point for the first time). By increasing P, the rise time will decrease. However, overshoot will increase and may also render the system unstable (fast hunting). Using only the P factor will always leave a difference between the set point and the actual value (this difference is also called droop).

The I parameter reduces the difference between the set point and the actual value. By increasing I, the rise time will decrease. However, overshoot will increase and may also render the system unstable (slow hunting).

The D parameter increases the stability and minimizes the overshoot phenomena. By increasing D, overshoot will decrease but the system may still be unstable, particularly if the measured signal is disturbed (sensor signal not filtered).

14.12.2 EMPIRICAL SETTING METHOD

First set G to 50%.

Set the parameters P, I and D to zero.

Increase the value of P until the system becomes unstable. From this position, decrease the value of P to 60% of the previous value.

Set I in the same way.

Increase D if the system is unstable upon fast load variation.

If stability cannot be achieved, restart the settings and reduce (system unstable) or increase (system too slow) G.

14.13 LOAD DEPENDANT START/STOP

14.13.1 INTRODUCTION

This function automatically controls the starting and stopping of generators of a power plant depending on the current load, whether paralleling with the mains or not. Coordination with the other GENSYS 2.0 units is done via the CAN bus (COM1).

Required configuration to allow automatic load / unload is:

- Remote start input must be active on each GENSYS 2.0 (connected to 0V). If remote start is off, the generator never starts.
- At least 2 generators must be equipped with GENSYS 2.0 units.
- Units must be in **[AUTO]** mode.

The useful variables to manage the load dependant start/stop function are available via the "Configuration/Power management system/Load dependant start/stop" menu.

14.13.2 PRINCIPLE

The automatic load/unload can be configured in 2 different ways:

- Standard mode.
- Optimised mode allowing to avoid that a large number of parallel generators run just above the unload threshold.

[E1914] parameter selects which mode will be used.

In standard mode, GENSYS 2.0 are configured:

- To start a generating set if the power plant load threshold [E1256] has been reach during a determined time [E1257].
- To stop a generating set if the power plant load is below the threshold [E1254] during a determined time [E1255].

In optimised mode, GENSYS 2.0 are configured:

- To start a generating set if the power plant load threshold [E1256] has been reached during a determined time [E1257] (same as in the standard mode).
- To stop a generating set if the power that will remain on the bus bar after the generating set stops is below threshold [E1915] during a determined time [E1255].



Since firmware version 4.55, it is also possible to setup a digital input that will stop a generating set after having checked that this will not overload the power plant according to the load dependant start/stop configuration. See chapter about digital inputs for more details.

Example:

Figures below show the difference between standard and optimised mode behaviour of a 4*100kW power plant with a load increasing linearly from 0 to 400kW and then decreasing to 0kW. In these examples, engine #1 is always running. When the load increases above the start threshold, engine 2 starts to help engine #1, then engine #3 and engine #4. When the load decreases, engine #4 is the first to stop, later followed by engine #3 and engine #2 as the global load continue to decrease.

In standard mode, start threshold [E1256] is set to 80% and the stop threshold [E1254] is set to 20%.

In optimised mode, start threshold [E1256] is set to 80% and the optimised load threshold [E1915] is set to 65%. In this mode we can see that when an engine "decides" to stop, the load on the remaining running engines is just below the "optimised load" value set in parameter E1915.

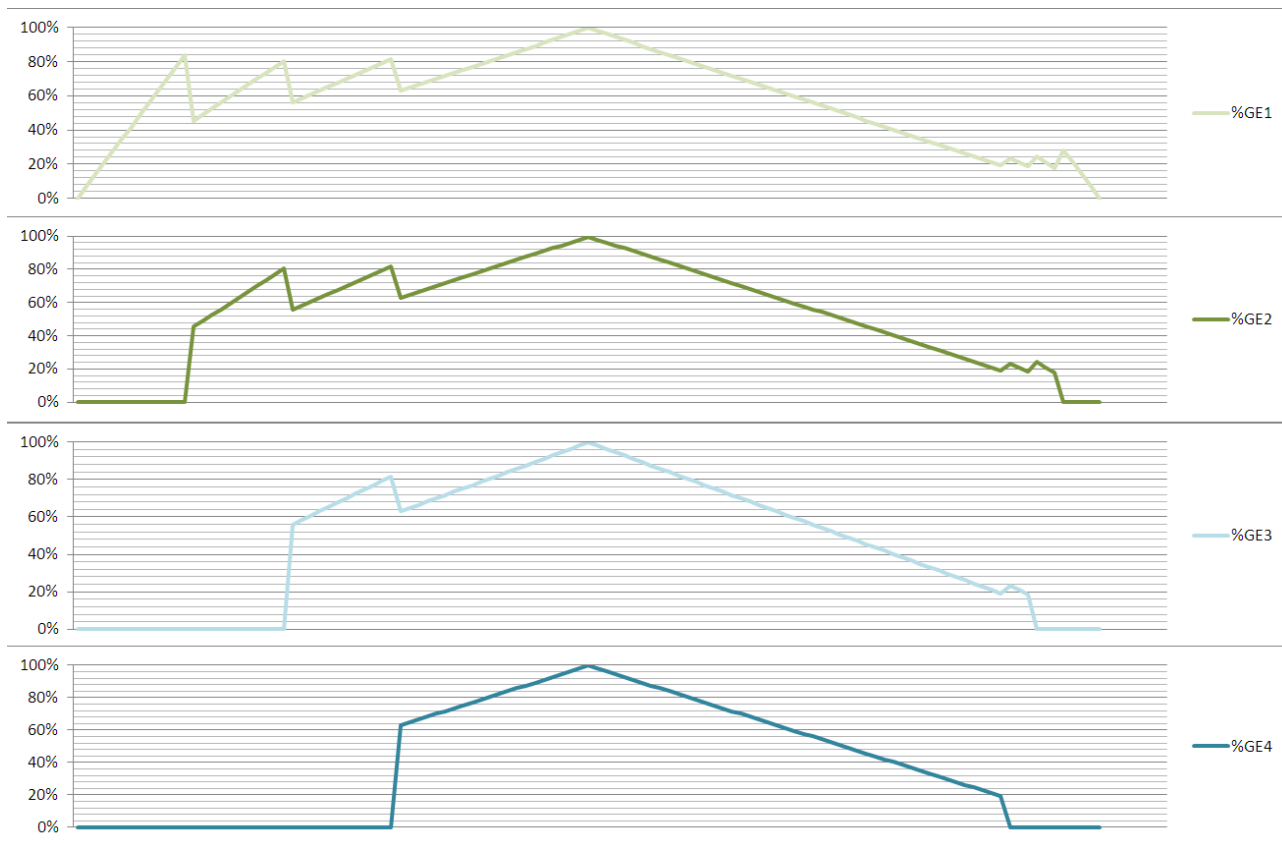

FIGURE 64 · STANDARD MODE - EXAMPLE WITH A 4X100KW POWER PLANT

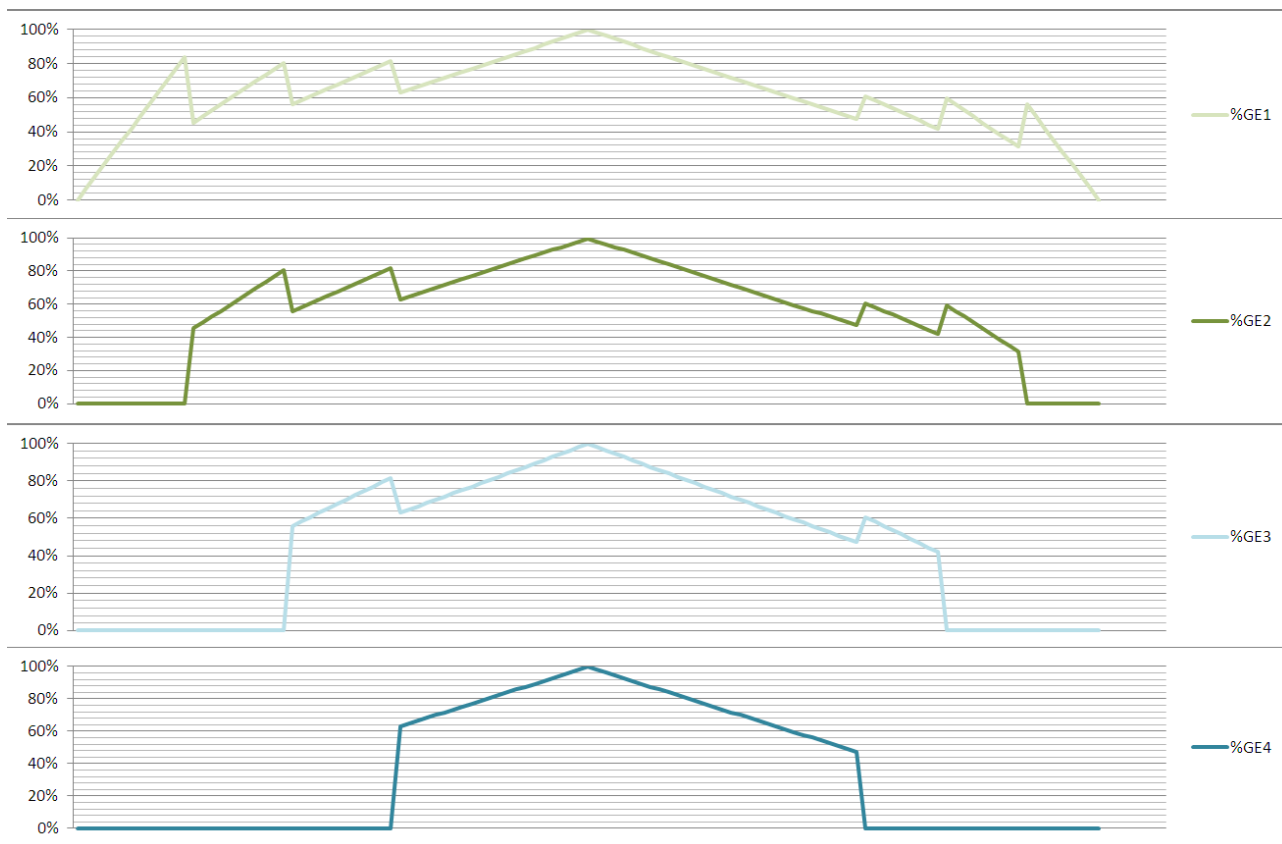

FIGURE 65 · OPTIMISED MODE - EXAMPLE WITH A 4X100KW POWER PLANT

The generating set that will start or stop can be selected in 3 different ways:

- By generator number (see chapter 14.13.3)
- By hours run (see chapter 0)
- By number of the [E1617] parameter (see chapter 14.13.5)

Selection mode is defined by parameter [E1258].

Note: If the management of the load dependant start/stop is inhibited (E1258= 0) the different GENSYS 2.0 units installed on the power plant do not interact to start or stop generating set according to the load demand.

14.13.3 START/STOP BY GENERATOR NUMBER

If this mode [E1258] = 1 has been selected on all units of the power plant, the automatic start/stop sequence will be done by the genset number, which is defined in the power plant overview.

If a digital or virtual digital input of one GENSYS 2.0 is set as priority generator, this GENSYS 2.0 will start first. The next to start will be decided by increasing genset number, which is defined in the power plant overview settings menu.

Example:

If the genset 3 has priority then :

- On increasing load demand, the next genset to start will be the genset 4 follow by genset 1.
- On decreasing load demand, the next genset to stop will be the genset 1 follow by the genset 4.

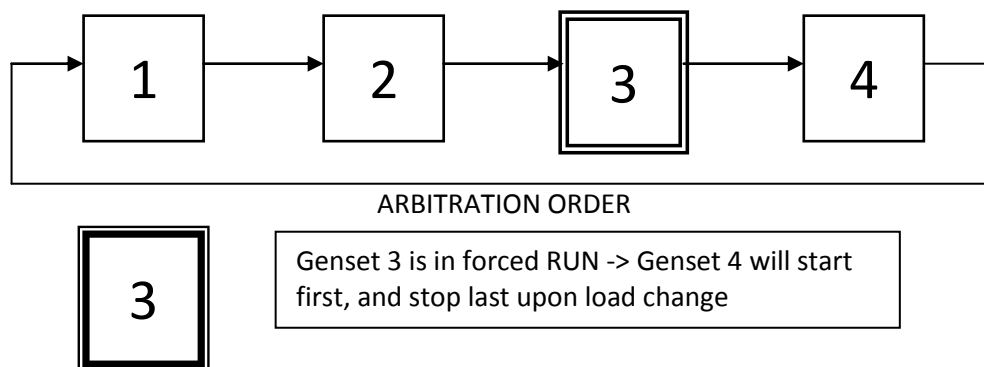

FIGURE 66 - AUTOMATIC LOAD/UNLOAD

Notes :

If there are no generators in "Forced running" mode, the priority generator with "remote start" always starts and closes its breaker on the bus bar, even if there is no load.

When all generators are stopped and have "remote start" activated, upon start-up the "Forced running" generators stay on the bus bar while the others coordinate stopping one by one.

14.13.4 START/STOP BY HOURS RUN

In this mode [E1258] = 2, the genset to start/stop will automatically be selected according to the GENSYS 2.0 hour meter.

- On increasing load demand, the next genset to be started is the one with fewest hours run
- On decreasing load demand, the next genset to be stopped is the one with highest hours run

Note: If a generator starts and goes past the hours run by a generator which is stopped, the first one does not immediately stop and the second one immediately start. Coordination between generators is activated only during a load or unload request, i.e. in the next start/stop on load request.

14.13.5 START/STOP BY (E1617) PARAMETER

In this mode [E1258] = 3, available in level 2, the genset start/stop sequence will follow the priority number set in each GENSYS 2.0 in the variable [E1617] as described below..

GE number	Value of [E1617] parameter
1	3
2	2
3	1
4	4

TABLE 40 - USE OF (E1617) PARAMETER

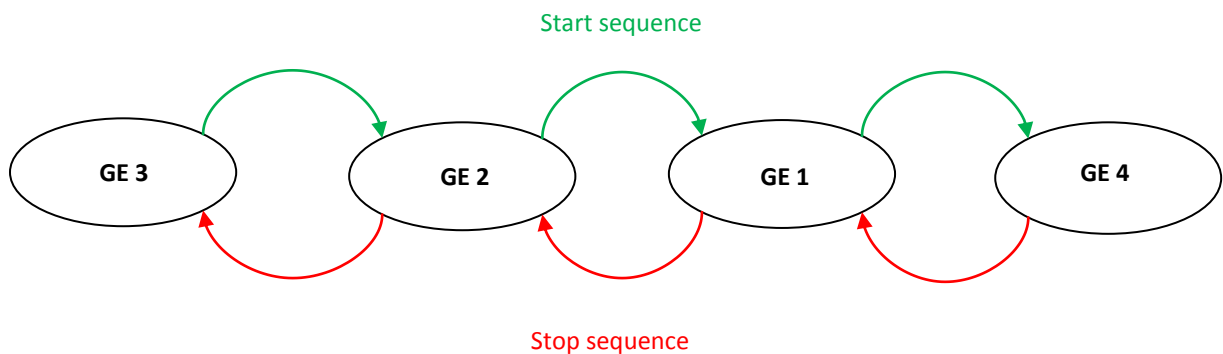

FIGURE 67- AUTOMATIC LOAD/UNLOAD SEQUENCE WITH CUSTOM E1617 MODE

14.14 PHASE OFFSET (DYN11 AND OTHER)

14.14.1 INTRODUCTION

This advanced function, available with option 8, provides a choice of **phase offset [E1929]** between mains and generator voltage measurement. That means that GENSYS 2.0 will command the breaker to close with the selected phase angle shift.

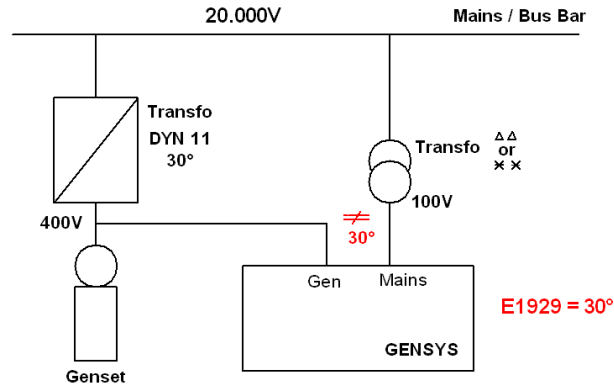

FIGURE 68 - PHASE OFFSET EXAMPLE



You must take care before choosing this function and modifying the phase offset parameter.

14.14.2 SETTINGS

The phase offset modification can be done via the configuration menu synchronization check relay (§19.3.10) by using the [E1929] parameter.

The **Phase offset [E1929]** can be chosen from the following values: 0°, +30°, +60°, +90°, +120°, +150°, 180°, -30°, -60°, -90°, -120° and -150°.

A modification of this parameter can be done only when the generator is stopped. Moreover a confirmation page will be displayed when modified the phase offset.

Note: After choosing your phase offset, you can lock this value by disabling the option 8.

14.15 VOLTAGE SYSTEM (120° THREE PHASES, 180° TWO PHASES, SINGLE PHASE)

Parameter [E4039] allows you to select the system to be used in the “Configuration/Power plant” menu.

System used	E4039
Three phase 120°	0 (default value)
Two phase 180°	1
Single phase	3

TABLE 41 - VOLTAGE SYSTEM

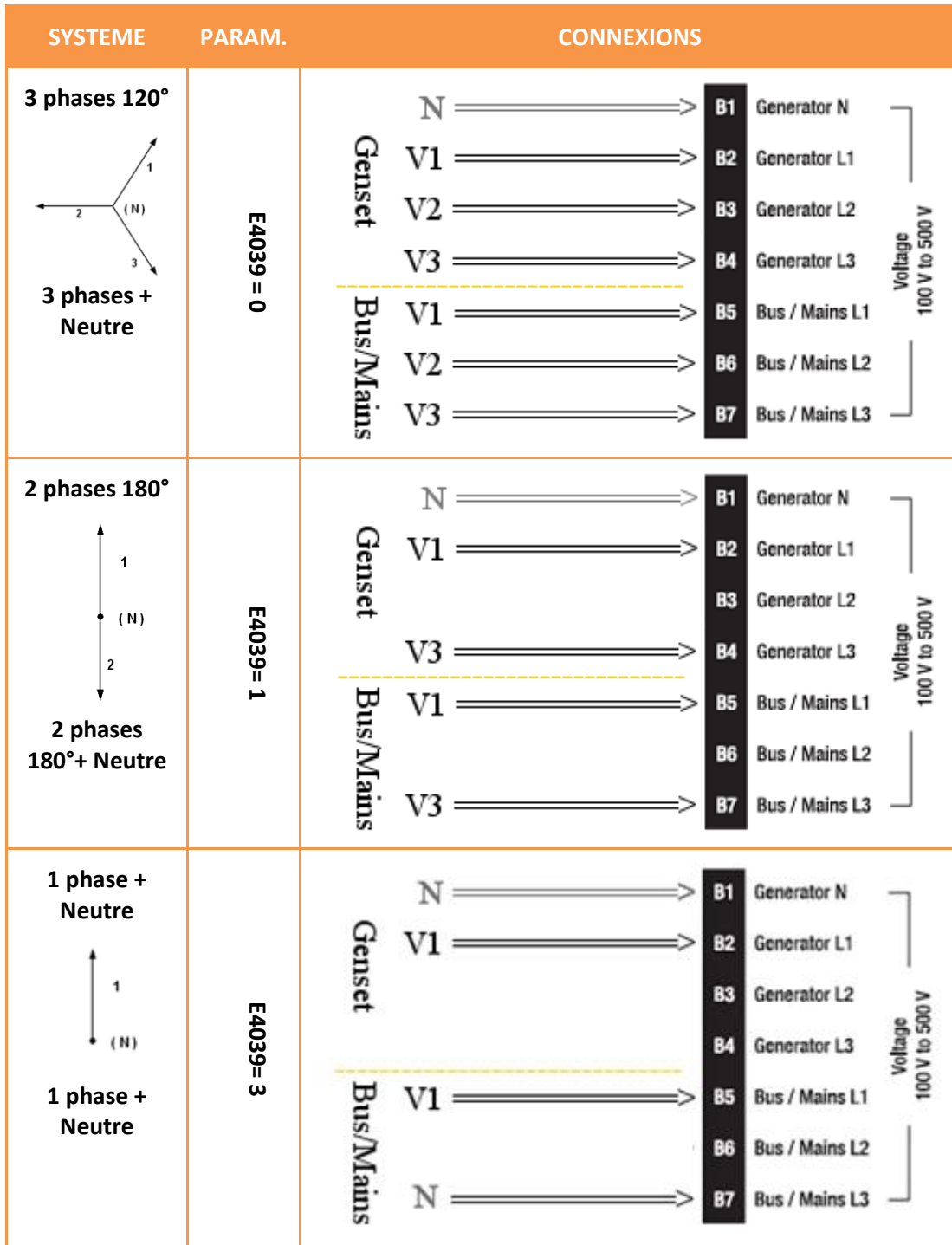

FIGURE 69 - VOLTAGE SYSTEM

14.16 MAINTENANCE CYCLE

Here you can setup custom cycles called maintenance cycles. User can set them up to schedule maintenance operation after the desired amount of running hours or days. 5 cycles are based on running hours timers, 5 cycles are on a day basis. To configure the maintenance cycle uses the **CRE Config** software or the parameters file.

When the cycle duration is elapsed, the corresponding alarm is raised.

Name: alarm name that will be displayed when cycle duration is elapsed.

Cycle timer: [E1442 to E1451]. Duration of the maintenance cycle (expressed in running hours or in days).

Counter: [E2304 to E2313]. Counter that will run for the desired duration.

Reset: [E4097 to E4106]. Resets corresponding counter to zero. A menu is dedicated to reset the maintenance cycle. (§19.3.13)

These timers are displayed in the “Display/Maintenance cycle monitoring”.

Note: Variables [E2304] to [E2313] are automatically managed by the module and saved into non volatile memory. These values are kept in memory even in case of power supply failure.

14.17 FRONT PANEL INHIBITION



Specific parameters can be setup and monitored to control each front panel button individually. Parameters [E0892] to [E0913] contain the status of the front panel button, a value of 1 means that the key is pressed while 0 means the key is released. Variables [E4043] to [E4064] are set to 1 to inhibit the use of selected front panel buttons.

Key	Status	Inhib.	Key	Status	Inhib.	Key	Status	Inhib.
	E0893	E4044		E0894	E4045		E0900	E4051
	E0895	E4046		E0896	E4047		E0901	E4052
	E0897	E4048		E0898	E4049		E0902	E4053
	E0892	E4043		E0899	E4050		E0903	E4054
	E0905	E4056		E0906	E4057		E0904	E4055
	E0907	E4058		E0910	E4061		E0913	E4064
	E0908	E4059		E0911	E4062		E0912	E4063
	E0909	E4060						

TABLE 42 - FRONT PANEL INHIBITION

15 ADVANCED MARINE FUNCTIONS



Functions below have been developed for advanced load management in marine applications. Associated parameters can be found in marine specific menus on the front panel or embedded Web site.

15.1 HEAVY CONSUMER

15.1.1 INTRODUCTION

Heavy consumer function is used in marine application in order to prevent to start an heavy consumer on a power plant that can't accept a such load.

Examples that use heavy consumer control: using of a crane in a harbour, manoeuvring a ship in/out of harbour using bow thrusters, etc.

Some external parameters must be analysed by GENSYS 2.0 units before accepting heavy consumer load.

- Analysis of available kW, number of generators on Busbar, or both.
- If Power Plant can accept load, heavy consumer authorization output is enabled.
- If Power Plant cannot accept load, another engine is started.
- One GENSYS 2.0 input is used to start analysis of power available on plant.
- One GENSYS 2.0 output is used to accept heavy consumer request.



Since firmware v4.55:

- Heavy consumer management can accept up to 4 different heavy consumer requests per GENSYS 2.0. Older versions only accept a single heavy consumer request.
- A power reserve can be fixed to ensure a permanent kW margin on running engines. If running engines are so loaded that they can't ensure this power reserve, then another generating set will start and share the load.

15.1.2 SETTINGS

Parameter [var.num.]	Possible value	Comment
CT Heavy [E1913]	Disable [0]	Heavy consumer function is not used (default).
	kW [1]	GENSYS 2.0 analyzes acceptable load on the Power plant. Engines start if necessary.
	MinNb [2]	Minimum number of engines necessary on the power plant for heavy consumer.
	kW & MinNb[3]	Analysis of both the power available and minimum number of engines.
Heavy consumer #1 [E1911]		Power used by heavy consumer number 1.
Min number of genset #1 [E1912]		Minimum number of engines that should run in order to accept heavy consumer number 1.

Parameter [var.num.]	Possible value	Comment
Heavy consumer #2 [E4121]		Power used by heavy consumer number 2.
Min number of genset #2 [E4122]		Minimum number of engines that should run in order to accept heavy consumer number 2.
Heavy consumer #3 [E4123]		Power used by heavy consumer number 3.
Min number of genset #3 [E4124]		Minimum number of engines that should run in order to accept heavy consumer number 3.
Heavy consumer #4 [E4125]		Power used by heavy consumer number 4.
Min number of genset #4 [E4126]		Minimum number of engines that should run in order to accept heavy consumer number 4.
Delay betw req [E4127]		Minimal delay between the authorization to load a heavy consumer and the processing of another heavy consumer request.
Power reserve⁽¹⁾ [E4128]		Power level that should always be kept on the power plant (i.e. running engines). This way a consumer smaller than this power level can be loaded instantly without the need of a heavy consumer request.

TABLE 4.3 - SETTINGS HEAVY CONSUMER

(1) Power reserve setting must be identical in all modules in order to work properly.

Some useful variables can be displayed in information page in order to understand the heavy consumer sequence.

Parameter [var.num.]	Comment
kW available [E2768]	kW available on power plant.
Help start [E2769]	Help request from another module.
Heavy proc. GE [E2937]	GE number managing the heavy consumer request.
Requested kW [E2939]	Expected kW before heavy consumer authorization
Requested qty GE [E2940]	Expected number of running engines before heavy consumer authorization.

TABLE 4.4 - USEFUL VARIABLES ON HEAVY CONSUMER

15.1.3 PROCEDURE

When a heavy consumer needs to be supplied, a digital input setup as heavy consumer request must be activated on a GENSYS 2.0 unit. If the conditions to accept this heavy consumer are met (the required number of engines are running and/or running engines can accept the specified load for this heavy consumer), then a heavy consumer authorization is issued by the unit on a digital output set up as “authorize heavy consumer”. If the conditions are not met, then another engine starts and connects on the bus bar to share the load before the authorization is issued by the unit.

If multiple heavy consumer requests are active at the same time, then the first one will be processed. When the authorization is issued (or if the request is removed), the unit will wait during the delay fixed by

parameter [E4127] before processing another heavy consumer request. This is made to ensure that the first heavy consumer has been turned on after the authorization has been issued.

Note : While an heavy consumer request is enabled, the automatic load/unload management is inhibited. The heavy consumer request has priority over automatic load/unload management.

Diagrams below represent heavy consumer sequences (requests/authorizations) when the system is set up to check the available kW (E1913=1) and when the system is set up to check the number of running engines (E1913=2).

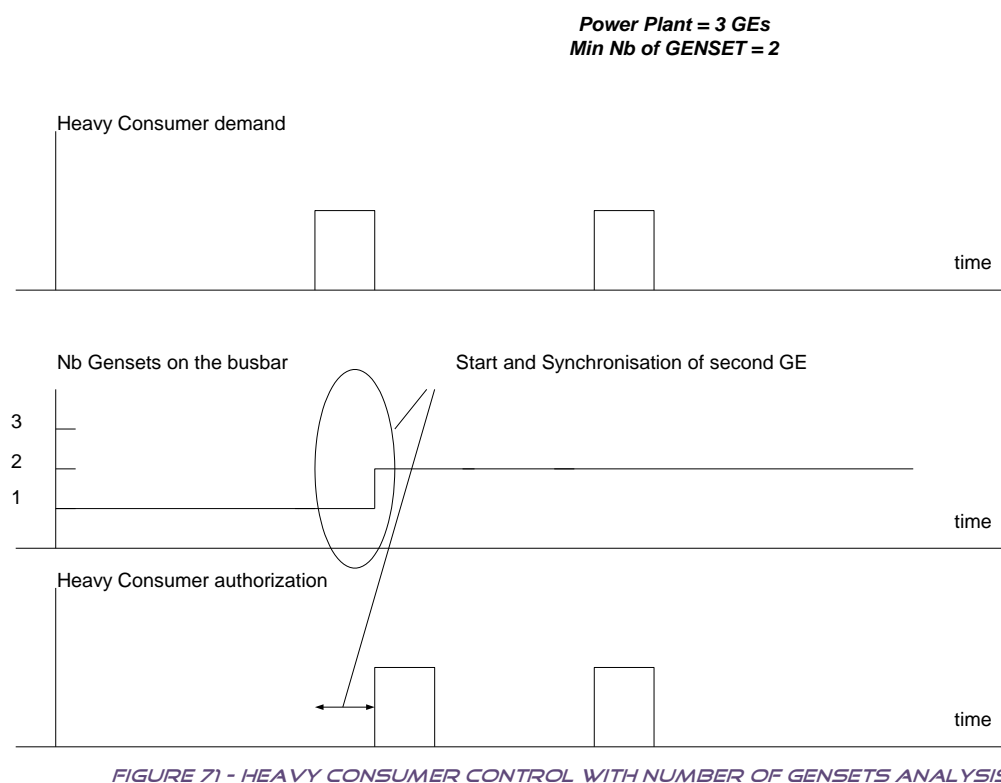
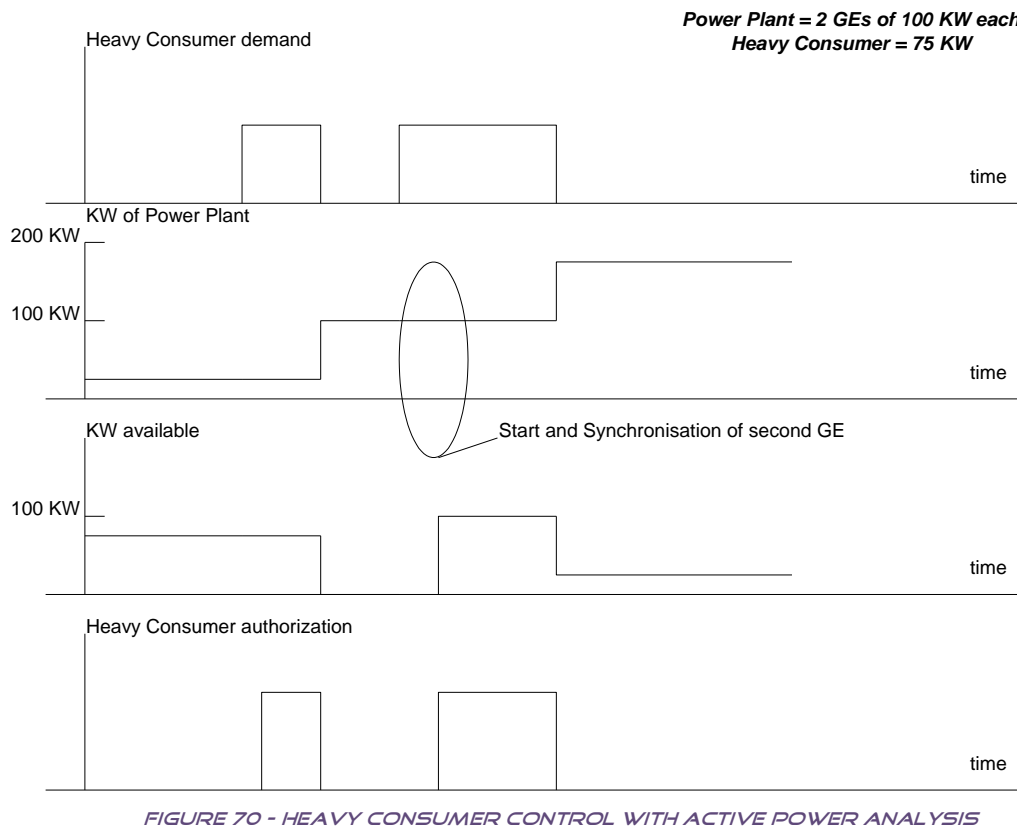

15.1.4 TYPICAL WIRING

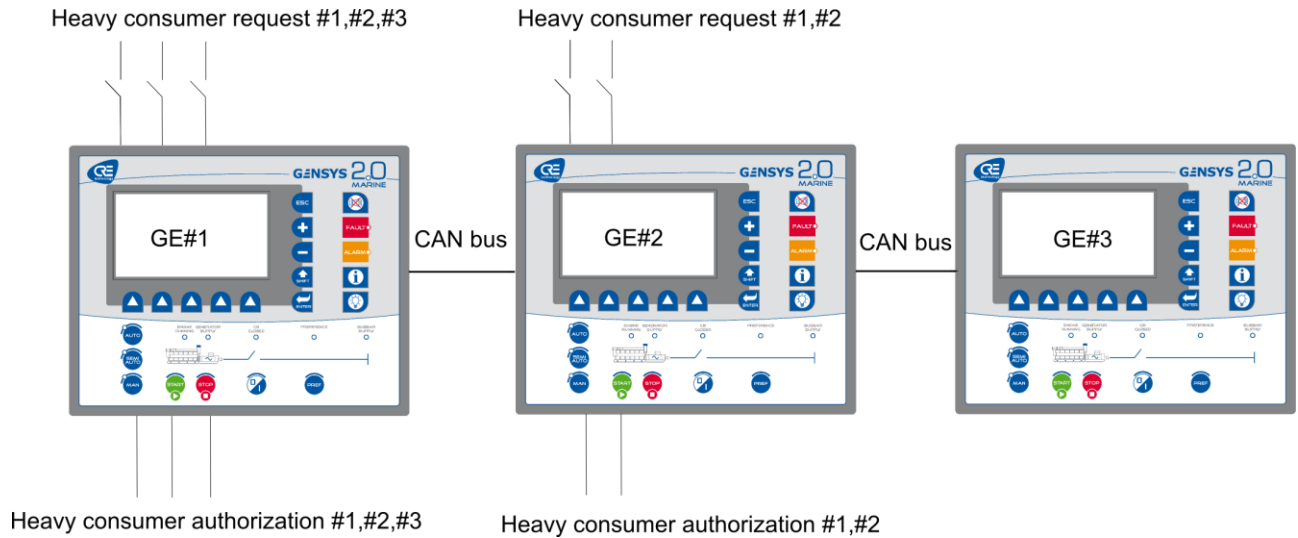

FIGURE 72 - HEAVY CONSUMER: TYPICAL WIRING

In the case above, the power plant accept 5 different heavy consumer requests.

- 3 heavy consumer requests are managed by GE #1,
- 2 heavy consumer requests are managed by GE#2,
- 0 heavy consumer request are managed by GE#3.

Each heavy consumer request input fit with an heavy consumer authorization output.

Notes :

The power used by heavy consumer #1 from GE#1 can be different from the power used by heavy consumer #1 from GE#2.

The heavy consumer #1 from GE#1 is linked to heavy consumer authorization #1 from GE#1. There is no relation between the heavy consumer #1 from GE#1 and the heavy consumer authorization #1 from GE#2.

15.2 NON-ESSENTIAL CONSUMER TRIP

15.2.1 INTRODUCTION

Non-essential consumer trip is the ability to disconnect less important consumers to prevent a black if the power plant is overloaded. If the generator reaches the overload or under frequency threshold for a given time, GENSYS 2.0 activates outputs to trip non-essential loads.

15.2.2 SETTINGS

Parameter [var.num.]	comment
Min Hz trip [E1905]	Enable/disable under frequency control for non-essential consumer trip feature.
Min Hz level 1 [E1903]	First level of under frequency control.
Min Hz level 2 [E1904]	Second level of under frequency control. (Should be set lower than level 1)
Max kW trip [E1908]	Enable/disable overload control for non-essential consumer trip feature.
Max kW level 1 [E1906]	First level of kW overload control.

Max kW level 2 [E1907]	Second level of kW overload control. (Should be set higher than level 1)
Level 1 delay [E1909]	Delay for the first level of control (kW and Hz).
Level 2 delay [E1910]	Delay for the second level of control (kW and Hz). (Should be set shorter than level 1 delay)

TABLE 45 - SETTINGS NON-ESSENTIAL CONSUMER

15.2.3 PROCEDURE

Using the two levels of thresholds and delays, you can setup your system in order to react more or less rapidly depending on the severity of the situation.

When one of the two control levels is reached and its associated delay overdue, variable E2729 “Trip alarm” switches to 1 and the trip out system is triggered. This means that a timer variable is run and will activate a “non-essential consumer trip” output each time this variable reaches the delay fixed by parameter E1894 “TM trip out”. Up to 5 “non-essential consumer trip” outputs can be activated this way. These outputs will remain active until both of these conditions are met:

- Generating set load and/or frequency are within the thresholds limits.
- Trip alarm is reset (for example using the front panel).

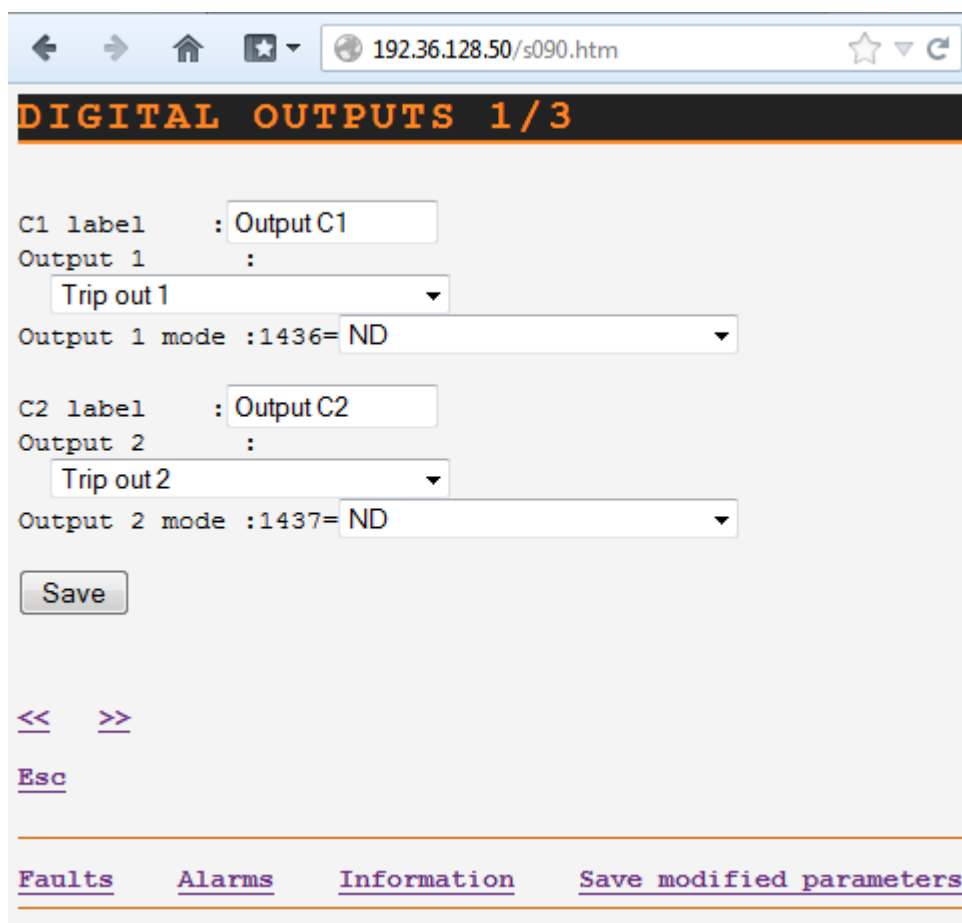

FIGURE 73- NON ESSENTIAL CONSUMER TRIP OUTPUT SETTING

Diagrams below show the behavior of the trip alarm and trip outputs depending on the load or the frequency of the generating set.

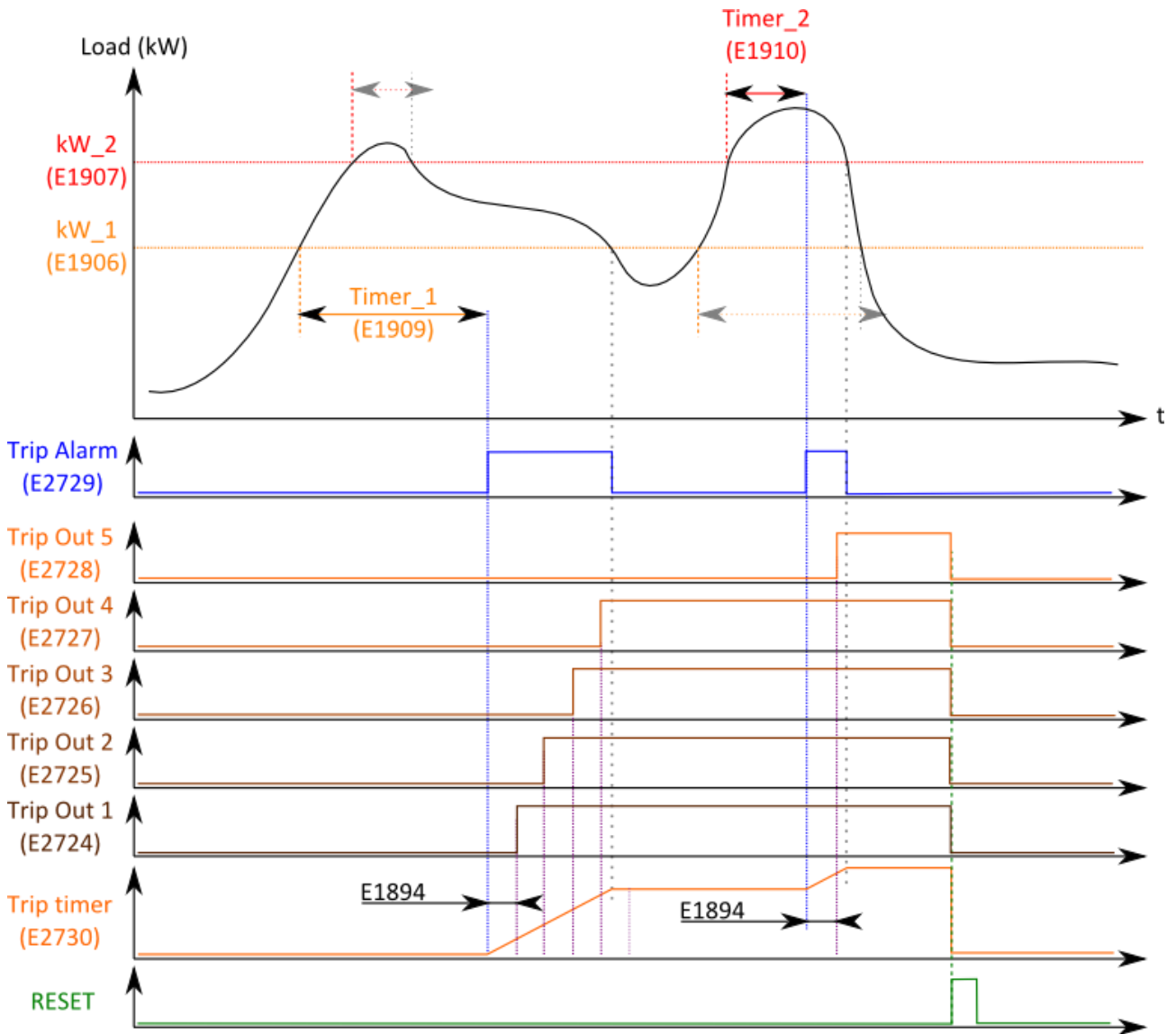

FIGURE 74: NON-ESSENTIAL CONSUMER TRIP (ON KW)

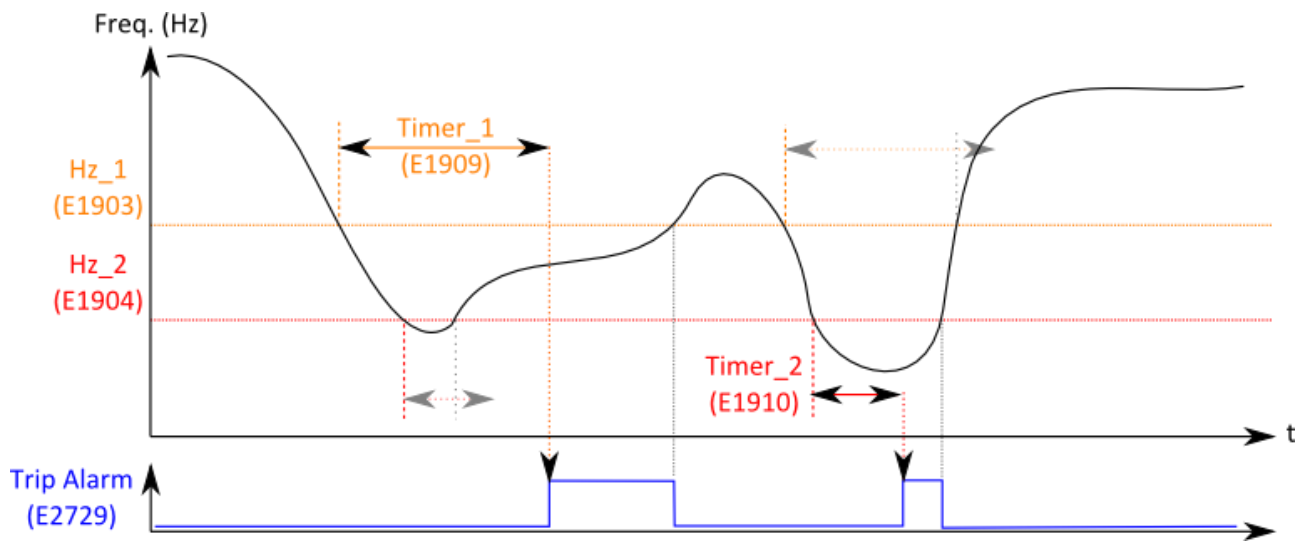

FIGURE 75: NON-ESSENTIAL CONSUMER TRIP (ON HZ)

15.3 CONNECTING MULTIPLE UNITS TO THE SHORE

Diagram below is an example showing how to connect a two engine power plant run by GENSYS 2.0 units to a shore through the use of a SELCO T4000 auto synchronizer. The output of this module is connected to analog input G1-G3 of both GENSYS 2.0 units, set up as a +/-10V input and used as a speed adjustment input

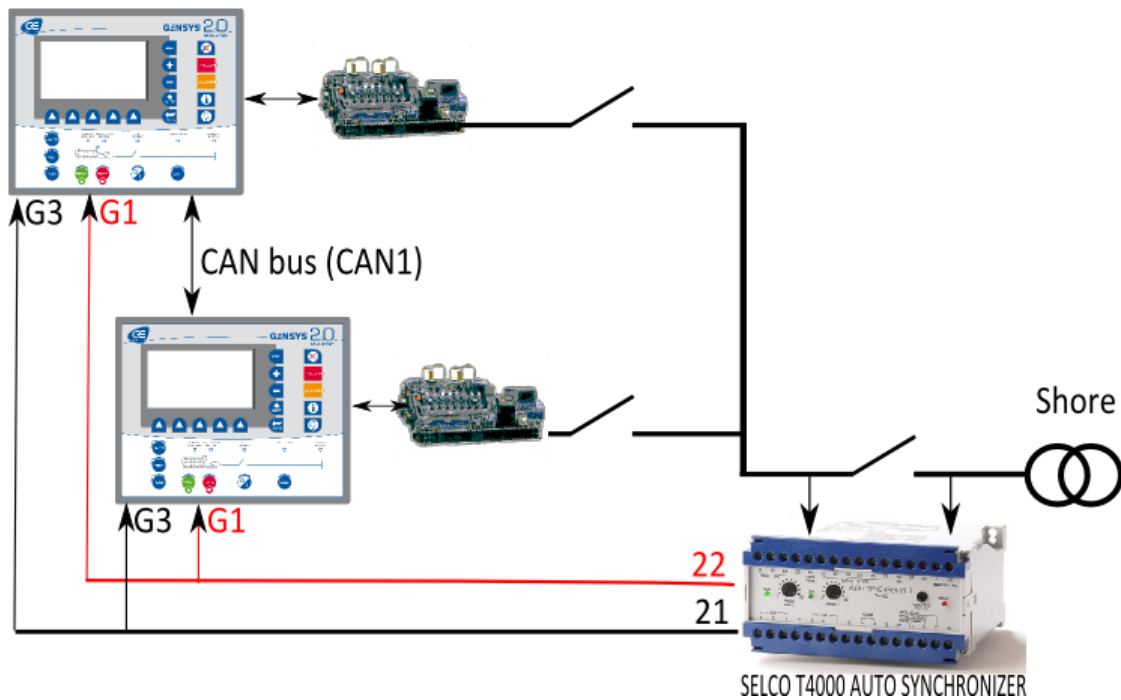

FIGURE 76: SHORE CONNECTION USING SELCO T4000

16 TEXT FILE & PLC

16.1 INTRODUCTION



GENSYS 2.0 LT doesn't support custom equations feature. References to equation in this chapter DO NOT APPLY to GENSYS 2.0 LT units.

The core system of the module is based on a list of predefined variables.

These variables can be used in a proprietary programming language. This language uses simple keywords in an ASCII text file. It is stored as a binary program for use with flash memory. A copy of the source file is also stored on module for documentation and readability purposes. This copy can be retrieved at any time to be modified or transferred to another module.

These equations can be used to add a logic equation and/or conditional function if your application requires non standard functions. It is also possible to change the predefined behavior with custom applications.

The PLC provided has a loop time of 100ms, and a special code can be defined to run the first time only (INIT). This chapter provides all resources for PLC programming.

A text file can be transferred to (§19.4.7) or from (§19.4.6) the module to set or retrieve the whole setup of the module.

The text file allows you to:

- ❖ Set the value of every parameter.
- ❖ Change the units of analogue inputs (example: V, mbar, PSI,).
- ❖ Change the accuracy when displaying analogue values (example: 24V or 24.0V).
- ❖ Change the labels of some custom inputs and the screensaver.
- ❖ Transfer custom equations to the embedded PLC.

16.2 VARIABLE NAMING

The file named "A53 Z0 9 0030x.xls" gives an explanation of each variable.

The variable number always uses the same format, the letter "E" followed by 4 digits:

EXYYY

The first digit, "X", is the type of variable:

0 and 5: Measurement or real time value (Ex: Voltage phase 1, CAN Bus Fault ...)

1 and 4: Parameter to be stored in non-volatile memory (Ex: Genset number, Nominal power ...)

2 and 3: General purpose variable (Ex: Alarms, PLC variables ...)

The next 3 digits "YYY" give the number of the variable.

All the parameters (Variable from 1000 to 1999 and from 4000 to 4999) of the module are stored in a non-volatile FLASH memory within the module. It is possible to download or upload these parameters with a computer, thus allowing the user to save, modify and reuse these parameters later.

All these values are stored in a text file. The following chapter describes the layout of the file.

The file can be exchanged between a PC and module, as described in §19.4.6 and §19.4.7. It can also be exchanged with the SD card as described in §17.7.3 .

16.3 TEXT FILE DESCRIPTION

The complete module configuration can be contained in a simple text file. This file can be downloaded from the module to be kept on a computer. It can also be manually edited on a computer and sent to a module to fully setup this module in a single step.

This text file is made up of 5 different blocks:

- ❖ Parameter values.
- ❖ Label definitions.
- ❖ Unit definitions.
- ❖ PLC initializations.
- ❖ PLC equations.

16.3.1 GENERATING AN EMPTY TEXT FILE TEMPLATE



The module can generate an empty template that contains the minimum requirement to write custom equations.

This can be done either:

1. By a computer connection to the embedded Web site in "System/GENSY5 2.0 -> PC file" menu (See §19.4.6 for more details)
1. By the front panel LCD using an SD card in "System/Communication ports config./COM6(SD CARD)" menu (See §17.7.3 for more details).

16.3.2 PARAMETER DEFINITION BLOCK

The starting point of this block is designated by a "{PARAMETERS}" statement.

Each parameter (1xxx or 4xxx variable) can be found as an input in this block. The structure of the input is as follows:

- ❖ The variable parameter number preceded by the letter V (Ex: V1006)
- ❖ The value (Ex: 320)
- ❖ R/W attribute (for MODBUS and PLC equations) (Ex: Y)
- ❖ The label (optional: only for user information) (Ex: Gen Nominal kW)
- ❖ The minimal value (optional: only for user information) (Ex: +00000)
- ❖ The maximal value (optional: only for user information) (Ex: +65535)
- ❖

Ex:

```
{ PARAMETERS }
V1006    320 Y    Gen nominal kW    +00000    +65535
V1007    1.00N    Gen PT ratio      +00000    +65535
```

In the example above, Genset nominal power is set to 320kW. The **Y** attribute shows that this value can be changed by MODBUS or custom PLC equations whereas the **N** attribute in the second line sets Generator PT ratio as "read only" for MODBUS and PLC equations.

Note: This write attribute can only be changed when using access level 2.

It is possible to modify the values directly in the text file before uploading it into the module. The user must be sure that the modified value is within the minimum / maximum range of the parameter. Failure to do so will lead to an error message during uploading (**Compilation result: VARIABLE**).

It is also possible to write an incomplete parameter block (not all parameters are displayed in the list). When uploaded, such a file will only modify the parameters which have been entered, the others remain unchanged. This procedure can be used to upload an old text file into a newer module or to activate special features independently.

16.3.3 LABEL DEFINITION BLOCK

The beginning of this block is shown by a "{LABELS}" statement.

This block is used to define custom labels.

Only the spare analogue inputs, the digital inputs, the virtual digital inputs, the maintenance cycle, and the lines in the Logo Page can have an input in this block. The table below shows the correspondence between the LABEL number and its associated value:

Identifier	Factory label	Description
L0029	AI oil press.	Oil pressure resistive sensor input
L0030	AI water temp.	Water temperature resistive sensor input
L0031	AI spare 1	Free resistive input 1
L0032	AI spare 2	Free resistive input 2
L2804 to L2805	Spare Input J4 ... Spare Input J15	Logic input J4 to J15
L2020 to L2024	Output C1 ... Output C5	Transistor outputs C1 to C5
L2913	Relay A1	Relay output A1
L2914	Relay A2	Relay output A2
L2283 to L2302	Virtual in 1 ... Virtual in 20	Virtual input 1 to 20
L2565 to L2584	Virtual in 21 ... Virtual in 40	Virtual input 21 to 20
L1442 to L1446	Cycle 1 (h) ... Cycle 5 (h)	Maintenance cycles (in running hours)

Identifier	Factory label	Description
L1447 to L1451	Cycle 1 (d) ... Cycle 5 (d)	Maintenance cycles (in days)
L2657	User meter 1	Free user counter n°1
L2659	User meter 2	Free user counter n°2

TABLE 46 - LABEL DEFINITION BLOC

Logo page labels	
T0249	GENSYS 2.0
T0250	CRE product
T0251	Genset Paralleling
T0252	www.cretechnology.com

TABLE 47 - CUSTOM LOGO LABELS

Each line of this block contains 2 elements:

-The variable number of the text, preceded by the letter L for label, and T for page logo.

Ex: L1130

-The text itself.

Labels are 14 characters long while Texts are 28 characters long maximum.

Ex: Sample Label

Supported characters include [a..z], [A..Z], [0..9] and the following graphical characters:

<space> ! # \$ () * + / : ; < = > [] ^ _ . -

All other characters are considered as insecure, and their use is prohibited. Their use can result in a bad display.

Ex:

```
{LABELS}
L1130 Sample label
```

Note: The label is language sensitive, i.e. a text file uploaded with PC language set to French will modify only the French labels. The English or Italian labels will remain unchanged. For the same reason, a text file uploaded with PC language set to French will display only French labels.

You must switch to the desired language before uploading/downloading a text file. Change the language (menu System/ "Back light timer / Languages"/"Local language") before changing the desired label.

16.3.4 UNITS AND ACCURACY DEFINITION BLOCK

The beginning of this block is shown by a "{UNITS}" statement.

This block defines what kind of units and accuracy will be associated with each analogue value input (analogue inputs, virtual inputs, and CANopen analogue inputs).

You only need to define the unit of the analogue input itself. All associated parameters (thresholds for instance) will automatically be modified in accordance. This includes native analogue inputs, extension CANopen analogue inputs, and virtual inputs.

The table below lists the different units supported by the module.

Only the 4 analogue inputs have an entry in this bloc (see file named Z090030.xls for variable number).

The structure of a unit/accuracy definition consists of the variable number preceded by a letter (U for Unit, A for Accuracy definition) and followed by a code as shown in the examples below.

The input is as follows:

```
{UNITS}
U0029 01
U2584 00
A0029 0000032768
```

The tables below give you the list of codes which correspond to the supported units and accuracies. In the examples above, input E2584 has no specific unit while input E0029 will be displayed in Volts (Unit code 01) and with 2 decimal digits (Accuracy code 32768).

Code	Accuracy
00000	1
16384	0.1
32768	0.01
49152	0.001

TABLE 48 - ACCURACY CODES

Code	Unit	Code	Unit	Code	Unit	Code	Unit	Code	Unit
Electrical		Power		Pressure		Volume		Time	
00	“ ”	07	kW	13	Bar	20	L	24	s
01	V	08	kWh	14	mBar	21	m3	25	h
02	kV	09	kVAR	15	kPa	22	mm3	26	days
03	mA	10	kVARh	16	PSI	23	Gal	Time related	
04	A	Rotating speed		Temperature				27	Hz/s
05	kA	11	rpm	17	°			28	m3/h
Frequency		Percent		18	°C			29	L/h
06	Hz	12	%	19	°F			30	Gal/h

TABLE 49 - UNITS CODES

Code Variable number	Default unit code	Default accuracy code	Description	Label
Native analogue inputs				
0029	14	00000	Analogue measure of oil pressure (0-400Ω)	AI oil press.
0030	18	00000	Analogue measure of water temp (0-400Ω)	AI water temp.

Code Variable number	Default unit code	Default accuracy code	Description	Label
0031	00	00000	Analogue measure of analogue 1 (0-10kΩ)	AI spare 1
0032	00	00000	Analogue measure of analogue 2 (0-10kΩ)	AI spare 2
Analogue inputs for CANopen extensions				
0285	00	16384	analogue input 1	Analog in 01
0286	00	16384	analogue input 2	Analog in 02
0287	00	16384	analogue input 3	Analog in 03
0288	00	16384	analogue input 4	Analog in 04
0289	00	16384	analogue input 5	Analog in 05
0290	00	16384	analogue input 6	Analog in 06
0291	00	16384	analogue input 7	Analog in 07
0292	00	16384	analogue input 8	Analog in 08
0293	00	16384	analogue input 9	Analog in 09
0294	00	16384	analogue input 10	Analog in 10
0295	00	16384	analogue input 11	Analog in 11
0296	00	16384	analogue input 12	Analog in 12
0297	00	16384	analogue input 13	Analog in 13
0298	00	16384	analogue input 14	Analog in 14
0299	00	16384	analogue input 15	Analog in 15
0300	00	16384	analogue input 16	Analog in 16
0301	00	16384	analogue input 17	Analog in 17
0302	00	16384	analogue input 18	Analog in 18
0303	00	16384	analogue input 19	Analog in 19
0304	00	16384	analogue input 20	Analog in 20
0305	00	16384	analogue input 21	Analog in 21
0306	00	16384	analogue input 22	Analog in 22
0307	00	16384	analogue input 23	Analog in 23
0308	00	16384	analogue input 24	Analog in 24
0309	00	16384	analogue input 25	Analog in 25
0310	00	16384	analogue input 26	Analog in 26
0311	00	16384	analogue input 27	Analog in 27
0312	00	16384	analogue input 28	Analog in 28
0313	00	16384	analogue input 29	Analog in 29
0314	00	16384	analogue input 30	Analog in 30
0315	00	16384	analogue input 31	Analog in 31
0316	00	16384	analogue input 32	Analog in 32
0317	00	16384	analogue input 33	Analog in 33
0318	00	16384	analogue input 34	Analog in 34
0319	00	16384	analogue input 35	Analog in 35
0320	00	16384	analogue input 36	Analog in 36
0321	00	16384	analogue input 37	Analog in 37
0322	00	16384	analogue input 38	Analog in 38
0323	00	16384	analogue input 39	Analog in 39
0324	00	16384	analogue input 40	Analog in 40
0325	00	16384	analogue input 41	Analog in 41
0326	00	16384	analogue input 42	Analog in 42
0327	00	16384	analogue input 43	Analog in 43

Code Variable number	Default unit code	Default accuracy code	Description	Label
0328	00	16384	analogue input 44	Analog in 44
Virtual inputs (first block)				
2283	00	00000	Virtual input Spare 1	Virtual in 01
2284	00	00000	Virtual input Spare 2	Virtual in 02
2285	00	00000	Virtual input Spare 3	Virtual in 03
2286	00	00000	Virtual input Spare 4	Virtual in 04
2287	00	00000	Virtual input Spare 5	Virtual in 05
2288	00	00000	Virtual input Spare 6	Virtual in 06
2289	00	00000	Virtual input Spare 7	Virtual in 07
2290	00	00000	Virtual input Spare 8	Virtual in 08
2291	00	00000	Virtual input Spare 9	Virtual in 09
2292	00	00000	Virtual input Spare 10	Virtual in 10
2293	00	00000	Virtual input Spare 11	Virtual in 11
2294	00	00000	Virtual input Spare 12	Virtual in 12
2295	00	00000	Virtual input Spare 13	Virtual in 13
2296	00	00000	Virtual input Spare 14	Virtual in 14
2297	00	00000	Virtual input Spare 15	Virtual in 15
2298	00	00000	Virtual input Spare 16	Virtual in 16
2299	00	00000	Virtual input Spare 17	Virtual in 17
2300	00	00000	Virtual input Spare 18	Virtual in 18
2301	00	00000	Virtual input Spare 19	Virtual in 19
2302	00	00000	Virtual input Spare 20	Virtual in 20
Virtual inputs (second block)				
2565	00	00000	Virtual input Spare 21	Virtual in 21
2566	00	00000	Virtual input Spare 22	Virtual in 22
2567	00	00000	Virtual input Spare 23	Virtual in 23
2568	00	00000	Virtual input Spare 24	Virtual in 24
2569	00	00000	Virtual input Spare 25	Virtual in 25
2570	00	00000	Virtual input Spare 26	Virtual in 26
2571	00	00000	Virtual input Spare 27	Virtual in 27
2572	00	00000	Virtual input Spare 28	Virtual in 28
2573	00	00000	Virtual input Spare 29	Virtual in 29
2574	00	00000	Virtual input Spare 30	Virtual in 30
2575	00	00000	Virtual input Spare 31	Virtual in 31
2576	00	00000	Virtual input Spare 32	Virtual in 32
2577	00	00000	Virtual input Spare 33	Virtual in 33
2578	00	00000	Virtual input Spare 34	Virtual in 34
2579	00	00000	Virtual input Spare 35	Virtual in 35
2580	00	00000	Virtual input Spare 36	Virtual in 36
2581	00	00000	Virtual input Spare 37	Virtual in 37
2582	00	00000	Virtual input Spare 38	Virtual in 38
2583	00	00000	Virtual input Spare 39	Virtual in 39
2584	00	00000	Virtual input Spare 40	Virtual in 40

TABLE 50 - VARIABLES WITH CUSTOMIZABLE UNIT/ACCURACY VALUES

16.3.5 INITIALIZATION DEFINITION BLOCKS

The beginning of these blocks is shown by the statements "{INIT1}" or "{INIT2}" depending on the level of access (1st or 2nd level password).

A user connected in level 0 (no password) cannot read equations from, or transfer equations to, the module.

A user connected in level 2 will get access to INIT1 and INIT2 blocks.

A user connected in level 1 will only get access to the INIT1 block.

INIT equations are only run once by the PLC when it is powered on. They won't be run again until power supply is switched OFF and ON again. INIT blocks are typically used to set the initialization values of outputs, timers or counters associated to custom equations or custom parameters.

For further details on programming equations, see §16.4.

16.3.6 EQUATION DEFINITION BLOCKS

The beginning of these blocks is shown by the statements "{EQUATIONS L1}", "{EQUATIONS L2}", depending on the level of access (1st level password or 2nd level password).

A user connected in level 0 (no password) cannot read equations from or transfer equations to the GENSYS 2.0.

A user connected in level 2 will get access to **EQUATIONS L1** and **EQUATIONS L2** blocks.

A user connected in level 1 will only get access to **EQUATIONS L1** block.

The purpose of these blocks is to provide custom equations to the user. These equations are run every 100ms (PLC cycle time). Custom equations can be entered here to handle user defined features like thresholds, Input/Output expansions or any other application specific feature.

For further details on programming equations, see §16.4.



Note: The L1 and L2 equations file size must not exceed 60 kB.

16.3.7 END OF FILE

Every text file must end with the "{END OF FILE}" statement.

The module will not try to read data following that statement, so you can place your own comments here.

Note: It is strongly recommended not to add too many comments after the "End of File" statement because the size of the file must not exceed 126 kB.

	<p>Warning: This file is a text ONLY file. Do not use word processors (like Microsoft® Word) to edit this file: it would include layout information and corrupt the file. Use text editors only (Notepad for example). The file should not exceed 126Kbytes. If you try to transmit a bigger file to a module, it will be rejected.</p>
	<p>Warning: Power control and protections are disabled while the module is processing a file. When you download or upload a file, you have to disconnect all connectors, except power supply. You must be in manual mode, with engine stopped.</p>

16.4 WRITING CUSTOM PLC EQUATIONS

It is strongly advised that you follow a specific training before using custom PLC equations on a power plant. Contact your local dealer for details on training sessions.

PLC equations use a simple language with a small number of commands. The code is intrinsically linear, each equation being executed one after the other (without any loop). Level 1 equations are executed first, followed by level 2 equations. This way, level 2 equations will overwrite any conflicting level 1 equation result.

All the module variables can be used in the equations in the way defined below:

- E0xxx and E5xxx are read only as measurements/inputs. They can't be changed by equations.
- E1xxx and E4xxx parameters can be read by equations. If allowed, they can also be modified using MODBUS or equations downloaded via the text file. See {PARAMETERS} section of the text file chapter or MODBUS chapter for more details concerning read/write attribute of these parameters.
- E2xxx are PLC output variables that can be read and written by equations. Yet write access should be used with great caution as some variables are internally used for the proper management of the generating set and its protections.



Starting from v4.55, a maximum of 10 modified parameters (E1xxx and E4xxx) is saved per PLC cycle. Variables E2xxx are not affected by this limitation. This is to prevent processor overload if too many parameters are changed using equations.

If you change more than 10 parameter values in a single PLC cycle, 10 of them will be saved at the end of the PLC cycle. 10 other parameters will be saved at the end of the next cycle if their values have been changed during that second cycle and so on.

This means that you can still modify many parameters in your equations if their value isn't changed at every cycle. Otherwise, you may miss some values.

16.4.1 EASY PLC

CRE technology has developed a graphical tool to help you design equations that will help you adapt your module to your specific application.

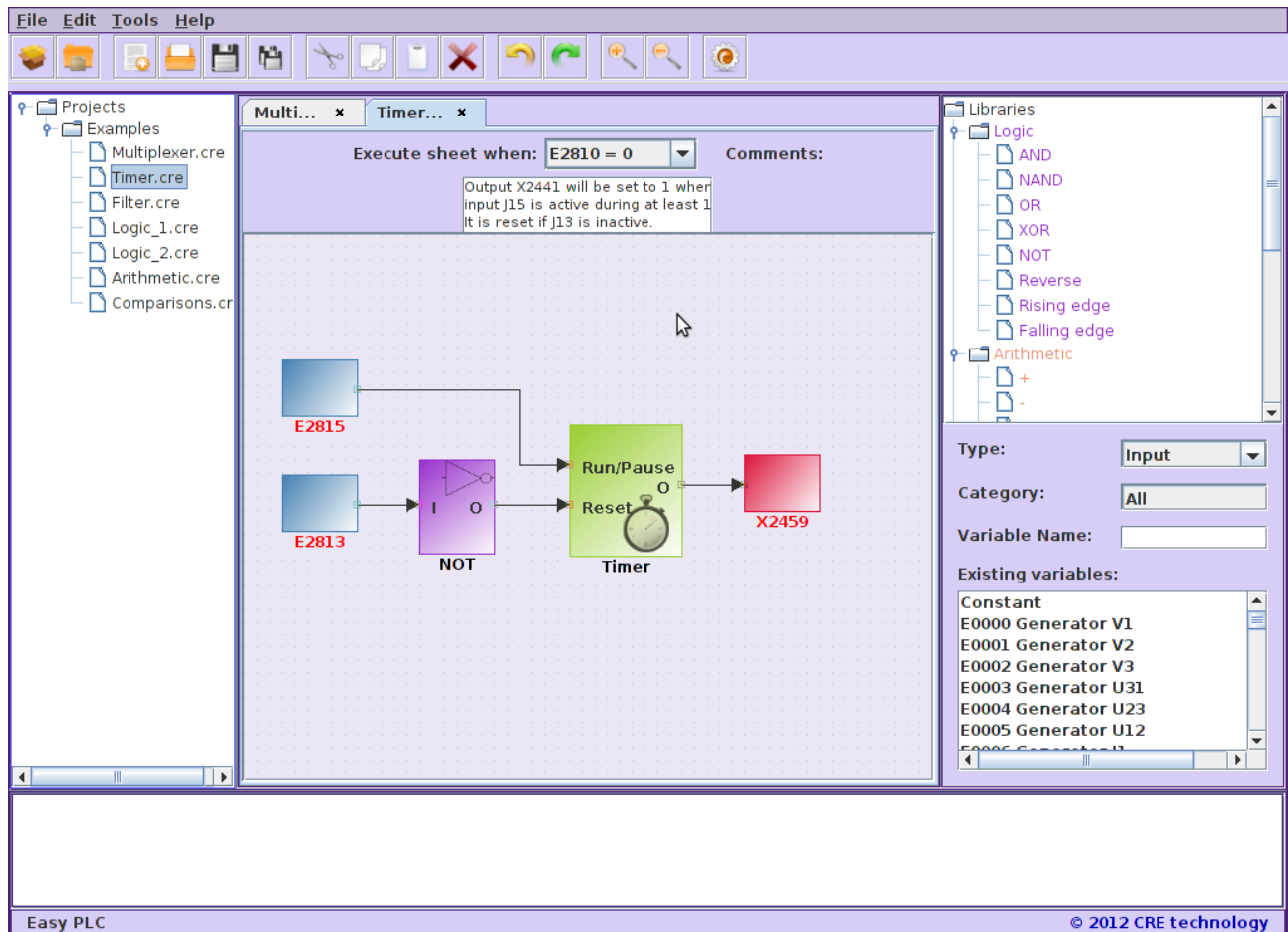

Easy PLC will check the syntax of your design and generate equations that you can then send to your GENSYS 2.0 unit using **CRE Config** software or the GENSYS 2.0 internal Web site.

Easy PLC is available for free on our Web site www.cretechnology.com. Refer to Easy PLC manual for more details.

16.4.2 ADVANCED PLC PROGRAMMING

Advanced applications may require complex equations manually written using PLC programming language instead of **Easy PLC** software. Such equations require a high knowledge of GENSYS 2.0 functioning modes and internal PLC features.

To achieve this and help you adapt your GENSYS 2.0 to the most complex applications, CRE technology can propose two solutions:

- Advanced training sessions on GENSYS 2.0 and its programming language.
- Development of equations according to your needs (Engineering service).

Feel free to contact CRE technology or your local distributor for more details on training sessions.

16.5 GENSYS 1.0 - GENSYS 2.0 COMPATIBILITY

Using a GENSYS 1.0 configuration file into a GENSYS 2.0 unit is a risky operation and requires excellent knowledge of the parameters and equations transferred.

New functions have been added to the GENSYS 2.0 which uses new variables. Certain GENSYS 1.0 variables have been redefined with new functions in the GENSYS 2.0.

Gensys A40Z0	GENSYS 2.0	Description
E2004 to E2015	E2804 to E2815	Logic inputs J4 to J15.

The references for GENSYS 1.0 variables E2004 to E2015 must be replaced with variables E2804 to E2815 in all the equations which will be introduced to the GENSYS 2.0. Note that a timer may now be associated to these variables by using variables E1998, E1999 and E1277 to E1286.

Special care must be taken with the following parameters if used in the GENSYS 2.0. Also check the read/write authorization (Y/N) which is associated with each parameter:

V1013	0	N	J1939 sc adres	+00000	+65535
V1017	60	N	J1939err delay	+00000	+65535
V1149	5.0	N	Fail to O/C br	+0000.0	+6553.5
V1476	0	N	Div D ILS	+00000	+65535
V1504	0	N	Div D Q share	+00000	+65535
V1517	1	N	RESET delay	+00000	+65535
V1596	125	N	CAN Speed	+00000	+65535
V1633	60	N	Fail to start	+00000	+65535
V1852	29	y	Branch P-oil	+00000	+65535
V1853	30	Y	Brnch T-water	+00000	+65535
V1854	33	Y	Branch Speed	+00000	+65535
V1855	0	Y	COM2 protocol	+00000	+65535
V1856	17	Y	J1939 Address	+00000	+65535
V1857	0	Y	CT speed +	+00000	+65535
V1858	0	Y	CT Oil Pres -	+00000	+65535
V1859	0	Y	CT Cool Temp +	+00000	+65535
V1860	0	Y	CT Oil Pres --	+00000	+65535
V1861	0	Y	CT Cool Temp++	+00000	+65535
V1862	0	Y	CT speed ++	+00000	+65535
V1863	0	Y	CT Malfonction	+00000	+65535
V1864	0	Y	CT Protection	+00000	+65535
V1865	0	Y	CT Orange	+00000	+65535
V1866	0	Y	CT Red	+00000	+65535
V1867	0	Y	Opt4Param12	+00000	+65535

V1868	0	Y	Opt4Param13	+00000	+65535
V1869	0	Y	Opt4Param14	+00000	+65535
V1870	0	Y	Opt4Param15	+00000	+65535
V1871	0	Y	Opt4Param16	+00000	+65535
V1916	0	Y	Fuel relay fct	+00000	+65535
V1925	60	N	CANopenErDelay	+00000	+65535
V1928	3	N	CT Fail synch	+00000	+65535
V1929	0	N	Phase offset	-32768	+32767

GENSYS 2.0 parameters listed above are shown with their default settings for the GENSYS 2.0. If your configuration file or variables modify these parameters, make sure their use is the same as in the GENSYS 2.0.

16.6 RESETTING TO FACTORY PARAMETERS

This function, only available in level 2, gives you the ability to reset your module into its factory configuration, thus erasing all changes made since the first use of the module, erasing all parameter changes and custom PLC. This can be done either from front panel or embedded Web site in menu “System/Reset factory settings”. Then simply select “reset”.

Note: For safety reasons parameters E1929 (Phase Offset – Option 8) will also be reset. Remember to set it manually if needed (for example when using Dyn11 transformer).

If the custom language has been changed, it will not be reset to factory custom language.

The passwords are not resetting.

16.7 DOWNLOAD A CUSTOM LANGUAGE FILE

This function allows to change the Custom language by another language. The unit contains 7 text types with different characteristics:

- *Labels* : text describing a variable on exactly 14 characters
- *Web page texts* : text not associated to a variable coded on 28 characters.
- *Power Status* : text describing the module state coded on 28 characters.
- *Engine Status* : text describing the engine state coded on 28 characters.
- *Units* : text associated to units coded on exactly 5 characters.
- *Modifiable labels*: text associated to modifiable labels (e.g. Inputs/outputs) coded on exactly 14 characters.
- *Logo screen saver texts* : text associated to main screen saver coded on 28 characters.

To update the Custom language, you have to use the **A53 Z0 9 0031 x-EN Translation Help Tool.xls** file that allows creating 2 translation files to download into the unit via the web site or by SD card:

- Open **A53 Z0 9 0031 x-EN Translation Help Tool.xls** file
- Activate the macros
- Click on **“Step 1 - Click here to prepare CUSTOM sheet”**
- Select the software version
- Click on OK button
A Custom tab appears.
- Translate texts label... into the desired language
- Click on **“Step 3 - Click here to check TXT validity”**
The script will check that translation are correct (label too long, too small, wrong characters,...)
If an error is detected, the error(s) will be underlined in red in the Custom tab.
If there is no error, 2 files containing the translations will be save on PC.
- Download these files into the unit via SD card or web site (see §17.7.3 or §19.4.7)

To display the updates, the unit must be configured in Custom language in « System/Languages » menu.

17 COMMUNICATION

17.1 CAN BUS GOOD PRACTICES

This chapter describes rules to be used to ensure reliable CAN communication. These rules must be applied to all CAN communications; including inter-GENSYS 2.0 CAN bus (COM1) and ECU/remote I/O CAN bus (COM2).

Table below lists the standard CAN DB9 wiring compared to GENSYS 2.0 DB9:

Terminal	GENSYS 2.0	Standard CAN	Mandatory
1	NC	Reserved	
2	CAN-L	CAN-L	X
3	GROUND-1	CAN GND	X
4	NC	Reserved	
5	GROUND-2	CAN SHLD (optional)	
6	GROUND-1	GND (optional)	
7	CAN-H	CAN-H	X
8	NC	Reserved	
9	NC	CAN V+ (optional)	
SHIELD	GROUND		X

TABLE 51 - DB9 PIN OUT

17.1.1 CAN BUS CABLE

Cables used must be selected to respond to CAN bus specificities. Always use 120Ω shielded twisted wire pairs. Shield should be connected to the metallic connectors of the cable. CAN bus must be deployed in a single line way (no star, ring or mesh connection) as shown below:

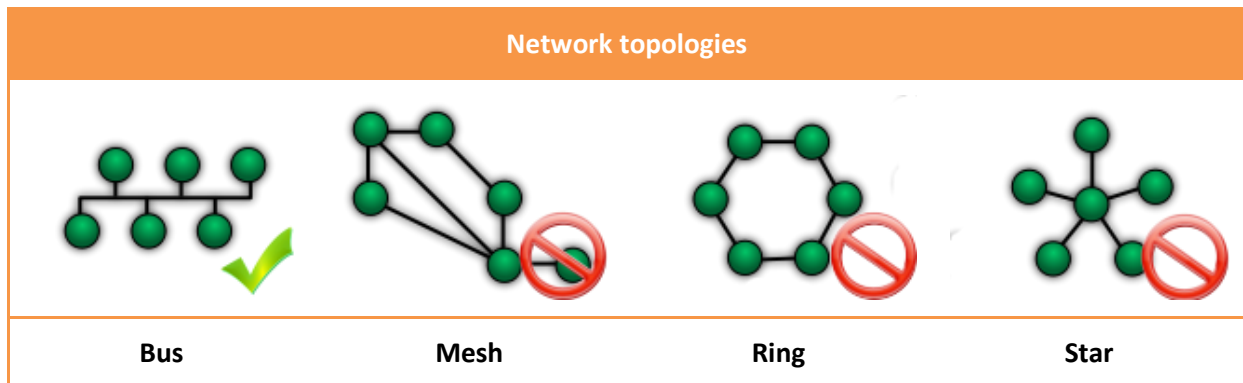

FIGURE 77 - NETWORK TOPOLOGIES

Both ends of the CAN bus must be terminated with 120Ω resistors. Such resistors are fitted into GENSYS 2.0 COM1 and COM2 and can be activated using DIP switches at the rear of the module under the “OFF / 120Ω” plug. Termination resistor is connected to the CAN bus when the switch is set to ON (“120Ω” side). When the switch is set to OFF, resistor is disconnected from the CAN bus.

Figure below gives the example of 3 CRE Technology modules connected through CAN bus. Terminal resistors must be activated as shown on the 2 modules located at both ends of the CAN bus.

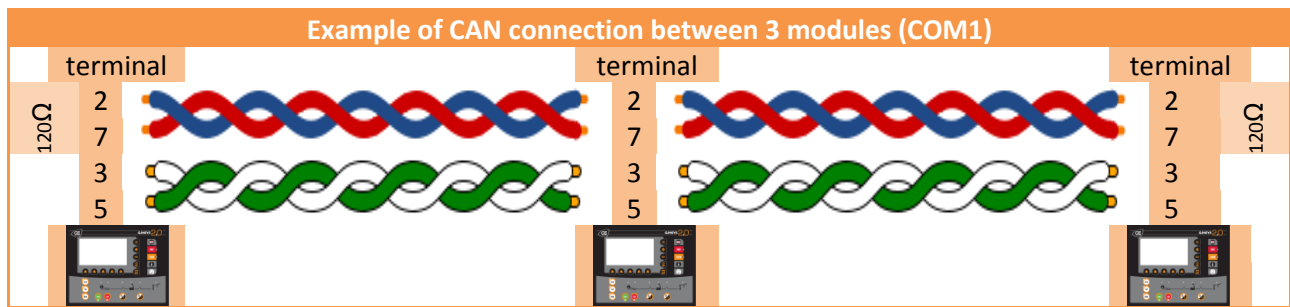

FIGURE 78 - EXAMPLE OF CAN CONNECTION BETWEEN 3 MODULES



CRE Technology provides a complete range of products aimed at installing your CAN bus (complete cables, wires, connectors...). Please contact your local CRE Technology distributor to help you choose adequate equipment to fit your needs.



WARNING:

Never plug or unplug the CAN bus connector when the unit is switch on. It could lead to internal damages on CAN transmitter/receiver.

17.1.2 MAXIMAL LENGTH OF A CAN BUS

The maximal length of a CAN bus mostly depends on the communication speed, but also on the quality of wires and connectors used. As said above, 120 Ω termination resistors should also be used appropriately.

Table below indicates the maximal length of a CAN bus depending on the communication speed.

Communication speed (kbits/s)	Maximal length (metres)
10	5000
20	2500
50	1000
125	500
250	250
500	100
800	50

TABLE 52 - MAXIMAL LENGTH / COMMUNICATION SPEED

Next table lists the standard communication speed of each CAN protocol that can be used by your CRE Technology module:

CAN bus	Protocol	Speed (kbits/s)	Note
COM1	CRE Technology protocol	125	Fixed
COM2	CANopen	125	[E1596] can be changed from 10 to 1000 kbps (By CRE Config software or modification by variable number)
	MTU MDEC	125	Fixed
	J1939 + CANopen	250	Fixed

TABLE 53 - SPEED COMMUNICATION (COM1 & COM2)

17.2 COM1: CRE TECHNOLOGY INTER-MODULES CAN BUS

This CAN bus is used as a communication means between modules (GENSYS 2.0/MASTER 2.0) from a single power plant. Features are:

- ❖ Active and reactive load sharing.
- ❖ Automatic load/unload.
- ❖ Static paralleling.
- ❖ Dead bus management.
- ❖ Other data exchange.

Standard CAN bus rules apply here. Please refer to chapter above to connect your modules properly through CAN bus.

17.2.1 CAN BUS FAULT

CAN communication between CRE Technology modules is continuously checked by each module on the CAN bus. The quantity of modules connected to the CAN bus should always be the same as the quantity of modules declared inside each product (sum of GENSYS 2.0 + MASTER 2.0 modules, parameters [E1147] and [E4006] respectively). Otherwise a **CAN bus** fault is triggered. This can also be the case if:

- ❖ Two or more units share the same module number (check parameter [E1179] on each module).
- ❖ 120Ω termination resistors are not used correctly (see chapter above).
- ❖ CAN bus cable is not properly connected.

This CAN bus fault can only be reset when the correct number of modules is seen on the CAN bus. As with every protection, the way to handle a CAN bus fault can be selected among the list below. This is done using parameter [E1259].

E1259 value	Behaviour when a CAN bus fault is triggered
0	No action
1	Generator electrical fault
2	Mains electrical fault
3	Alarm
4	Soft shutdown (with cool down sequence)
5	Hard shutdown (no cool down sequence)
6	Droop mode; generates an alarm

TABLE 54 - CAN BUS FAULT

Note that you may go to **Display/Power plant overview** pages to try to understand your wiring problem. For example on a 4 generating sets power plant, if module #3 is disconnected from CAN bus, you will only see its data in its **Display/Power plant overview** pages whereas you would see data from modules #1, #2 and #4 on the 3 other modules. This is shown on the drawing below.

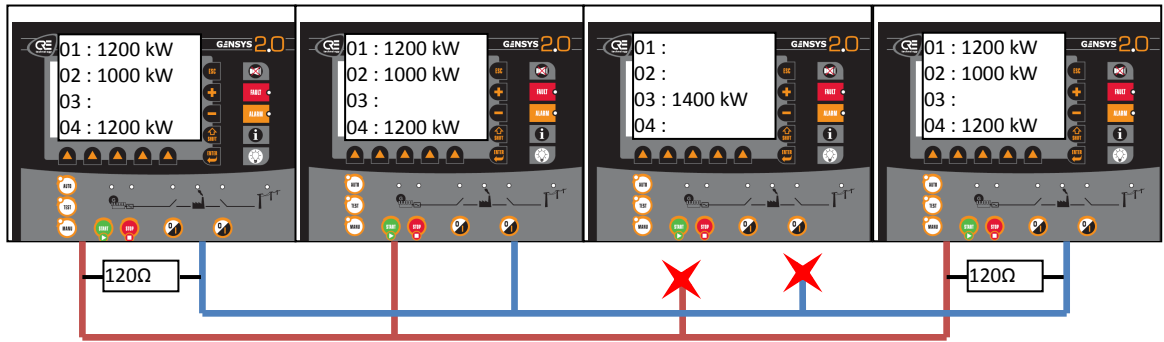

FIGURE 79- EXAMPLE CAN BUS FAULT

If a remote start occurs on a GENSYS 2.0 working in automatic mode and set up to manage Deadbus situations (E1515 = 0) and a CAN bus fault has already been triggered, GENSYS 2.0 will start its engine and close its breaker (if there is no voltage on the bus bar) after a delay that depends on the generator number [E1179]. If there is a voltage on the bus bar, GENSYS 2.0 will synchronize the generator before connecting to the bus bar.

If the generator is paralleled to the Mains when a CAN bus fault occurs, and error control variable [E1259] is set to 6 (Droop mode + Alarm), speed control will be switched to droop and volt control will be switched to power factor regulation. If the Mains are not connected, both speed and voltage droop is applied.

Note: If you need to disconnect a GENSYS 2.0 from the inter GENSYS 2.0 CAN bus, you must change the number of generators (parameter E1147) on all other GENSYS 2.0 units of the power plant.

When the power plant is set to load/unload mode (Parameter [E1258] set to "Hours run" or "GE number"), all generators will start using droop mode if a CAN bus error occurs.

17.2.2 BROADCASTING DATA BETWEEN MULTIPLE UNITS



Custom data can be sent from one unit to the others using simple custom equations. This is very useful to create your own advanced features and adapt your modules to your very specific requirements. It is possible to send up to 10 digital variables and 2 analogue variables from one CRE Technology unit to all other units connected to the same inter module CAN bus (COM 1).



FIGURE 80 - BROADCASTING DATA BETWEEN MULTIPLE UNITS

Variables associated to custom broadcast data sent to other units are described in the table below.

Variables used to send data to other modules	
Variable	Data type
E2752	1 st digital variable
E2753	2 nd digital variable
E2754	3 rd digital variable
E2755	4 th digital variable
E2756	5 th digital variable
E2757	6 th digital variable
E2758	7 th digital variable
E2759	8 th digital variable
E2760	9 th digital variable
E2761	10 th digital variable
E2762	1 st analogue variable
E2763	2 nd analogue variable

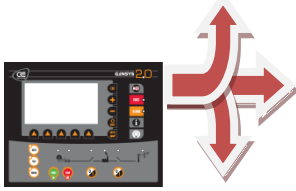

TABLE 55 - BROADCAST DATA SENT ON INTER MODULE CAN BUS

Custom equations are required to control data that will be sent to other modules. Variables [E2752] to [E2763] are pointers to the data that will be sent on CAN bus. This means that they should be assigned the variable number of the data you want to be broadcast to other modules.

Example:

In this example a main fuel tank is available to feed 4 generating set. A fuel level sensor is connected to the first spare analogue input of module number 2 (*Engine Meas. 1* on terminal F1-F2). So fuel level is measured and stored in variable [E0031] of module number 2. You may broadcast this fuel level to the 3 other CRE Technology modules by adding the following custom equation into module number 2:

X2762:= 31; @ This will send the value of variable E0031 to other modules;

This way, fuel level will be sent using 1st broadcast analogue variable. All modules will receive this fuel level into variable [E0562] (see below for broadcast data receiving variables).

It is important to understand that using this equation other modules will **not receive value "31"** but the **content of variable [E0031]**.

Data received from other modules are stored in the variables listed below.



Custom data received from other modules			
	1 st ...10 th digital variables	1 st ...2 nd analogue variables	Received from module n°
	E0536...E0545	E0546...E0547	1
	E0552...E0561	E0562... E0563	2
	E0568...E0577	E0578...E0579	3
	E0584...E0593	E0594...E0595	4
	E0600...E0609	E0610...E0610	5
	E0616...E0625	E0626...E0627	6
	E0632...E0641	E0642...E0643	7
	E0648...E0657	E0658...E0659	8
	E0664...E0673	E0674...E0675	9
	E0680...E0689	E0690...E0691	10
	E0696...E0705	E0706...E0707	11
	E0712...E0721	E0722...E0723	12
	E0728...E0737	E0738...E0739	13
	E0744...E0753	E0754...E0755	14
 Only for modules with firmware v4.00 and above	E0760...E0769	E0770...E0771	15
	E0776...E0785	E0786...E0787	16
	E6005...E6014	E6015...E6016	17
	E6035...E6044	E6045...E6046	18
	E6065...E6074	E6075...E6076	19
	E6095...E6104	E6105...E6106	20
	E6125...E6134	E6135...E6136	21
	E6155...E6164	E6165...E6166	22
	E6185...E6194	E6195...E6196	23
	E6215...E6224	E6225...E6226	24
	E6245...E6254	E6255...E6256	25
	E6275...E6284	E6285...E6286	26
	E6305...E6414	E6315...E6316	27
	E6335...E6444	E6345...E6346	28
	E6365...E6474	E6375...E6376	29
	E6395...E6404	E6405...E6406	30
	E6425...E6434	E6435...E6436	31
	E6455...E6464	E6465...E6466	32

TABLE 56 - BROADCAST DATA RECEIVED FROM INTER MODULE CAN BUS

Note: Even if CAN bus inhibition is activated between GENSYS 2.0 units (see chapter below), broadcast data is always sent to the CAN bus and received on the other units.

Analogue and digital data broadcast example

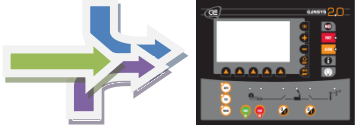
In this example, two GENSYS 2.0 are connected together using CAN bus COM1. Both units (GENSYS 2.0 #1 and GENSYS 2.0 #2) send two broadcast variables to each other on the CAN bus, one variable being digital input J6 (E2806) and the other one being analogue value E0033 (engine speed).

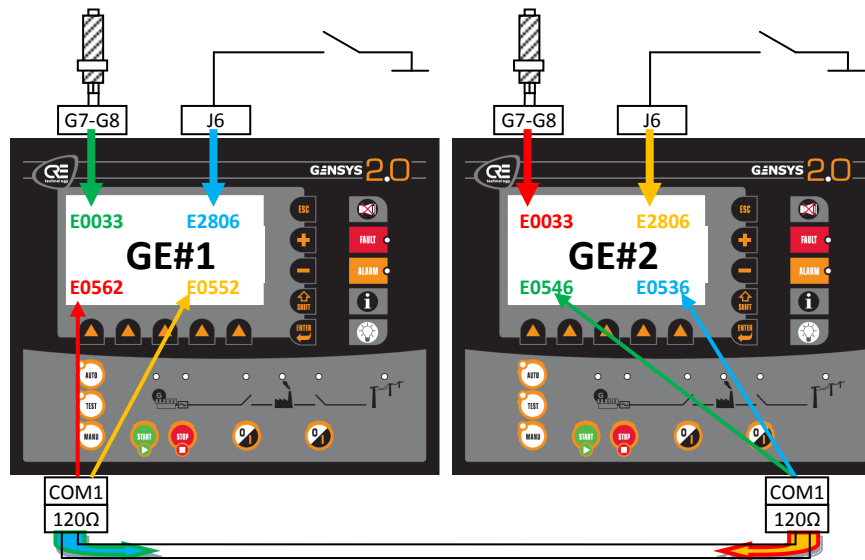

FIGURE 81 - ANALOGUE AND DIGITAL DATA BROADCAST EXAMPLE

To send desired data on CAN bus the following equations should be used on both GENSYS 2.0 units:

BLOC

@Send input J6 on CAN bus using first digital broadcast data;

X2752:=2806;

@Send engine speed on CAN bus using first analogue broadcast data;

X2762:=33

BEND

Following table lists variables used in GENSYS 2.0 to store data coming from the other unit.

Storage variables used	
GENSYS 2.0 #1 – digital input J6	Stored in E0536 of GENSYS 2.0 #2
GENSYS 2.0 #1 – engine speed	Stored in E0546 of GENSYS 2.0 #2
GENSYS 2.0 #2 – digital input J6	Stored in E0552 of GENSYS 2.0 #1
GENSYS 2.0 #2 – engine speed	Stored in E0562 of GENSYS 2.0 #1

TABLE 57 - ANALOGUE AND DIGITAL DATA BROADCAST EXAMPLE

17.2.3 CAN BUS INHIBITION



COM1 CAN bus is mainly used by GENSYS 2.0 modules to send power management data to each others. CAN bus inhibition is used to prevent one GENSYS 2.0 from taking into account data coming from one or more specific GENSYS 2.0 units. This is especially useful when tie breakers are used to change the configuration of the power plant (for example from a 6 generator power plant to two power plants with 3 generators each).

Variables below are used to decide with which modules the GENSYS 2.0 should communicate power management data.

	Variable	Description (when variable is set to 1)
All firmwares	E2691	Ignore power management data from GE01
	E2692	Ignore power management data from GE02
	E2693	Ignore power management data from GE03
	E2694	Ignore power management data from GE04
	E2695	Ignore power management data from GE05
	E2696	Ignore power management data from GE06
	E2697	Ignore power management data from GE07
	E2698	Ignore power management data from GE08
	E2699	Ignore power management data from GE09
	E2700	Ignore power management data from GE10
	E2701	Ignore power management data from GE11
	E2702	Ignore power management data from GE12
	E2703	Ignore power management data from GE13
	E2704	Ignore power management data from GE14
 Firmware v4.00 and above only	E2705	Ignore power management data from GE15
	E2706	Ignore power management data from GE16
	E2885	Ignore power management data from GE17
	E2886	Ignore power management data from GE18
	E2887	Ignore power management data from GE19
	E2888	Ignore power management data from GE20
	E2889	Ignore power management data from GE21
	E2890	Ignore power management data from GE22
	E2891	Ignore power management data from GE23
	E2892	Ignore power management data from GE24
	E2893	Ignore power management data from GE25
	E2894	Ignore power management data from GE26
	E2895	Ignore power management data from GE27
	E2896	Ignore power management data from GE28
	E2897	Ignore power management data from GE29
	E2898	Ignore power management data from GE30
E2899	Ignore power management data from GE31	
E2900	Ignore power management data from GE32	

TABLE 58 - CAN BUS INHIBITION VARIABLES

If one of these variables is set to one, power management data from the corresponding GENSYS 2.0 will not be taken into account.

Note: Broadcast data are not influenced by the value of these inhibition variables, so it is still possible to send and receive broadcast values between “inhibited” GENSYS 2.0.

Example below shows a power plant made up of 4 generators that can be split into two power plants of two generators each. GENSYS 2.0 units are connected together with a CAN bus on COM1. If it is necessary to split the complete plant using a tie breaker, then it is necessary to modify normal functioning:

- ❖ When the tie breaker is closed, each GENSYS 2.0 communicates with the 3 other units.
- ❖ When the tie breaker is open, all GENSYS 2.0 units need to know that they have to consider the power plant differently, with two separate bus bars. This is where we will use CAN bus inhibition.

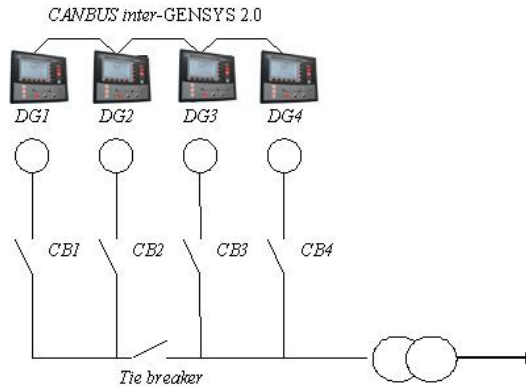

FIGURE 82 - CAN BUS INHIBITION SCHEMATIC (EXAMPLE)

When the tie breaker is closed, all four GENSYS 2.0 units should communicate with each other for power management, so variables [E2691] to [E2694] should be set to 0 (zero) on every GENSYS 2.0 unit (no CAN inhibition). When the tie breaker is open, generators DG1 and DG2 should communicate together but ignore data coming from DG3 and DG4. In the same way, generators DG3 and DG4 should communicate together but ignore data coming from DG1 and DG2.

To do so, inhibition variables should be set as shown in table below.

	4 generating sets power plant				2 * 2 generating sets power plant			
	Tie breaker is closed				Tie breaker is open			
	E2691	E2692	E2693	E2694	E2691	E2692	E2693	E2694
DG1	0	0	0	0	0	0	1	1
DG2	0	0	0	0	0	0	1	1
DG3	0	0	0	0	1	1	0	0
DG4	0	0	0	0	1	1	0	0

TABLE 59 - TIE BREAKER EXAMPLE

Note: In this example, feedback from the tie breaker can be connected to a GENSYS 2.0 digital input and used in PLC custom equations to set or reset appropriate inhibition variables.

17.3 COM2: CAN PROTOCOLS (CANOPEN, J1939, MTU MDEC):



GENSYS 2.0 LT doesn't support CANopen communication on COM2.

The COM2 port is a CAN bus communication port allowing to communicate with:

- Industrial extension modules CANopen (§17.3.1)
- electronic ECU using J1939 (§17.3.2)
- ECU MDEC from MTU (§17.3.3)

Note : CANopen is configured by default. It can be used in parallel with J1939 but not with the MTU-MDEC.

17.3.1 COM2: CANOPEN COMMUNICATION



Industrial CANopen extension modules can be used to increase the number of digital/analogue inputs and outputs of GENSYS 2.0.

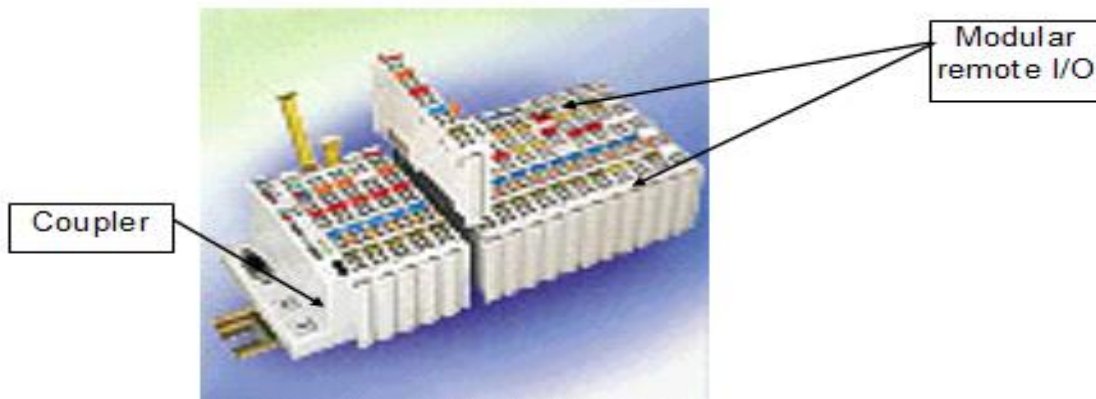

FIGURE 83 - MODULAR REMOTE CANOPEN I/O EXTENSION MODULE

The refresh rate of these CANopen inputs and outputs is 100ms.

Wiring of the CAN bus on COM2 should be as described in chapter 17.1 CAN bus good practices. Also refer to the CANopen extension module's user manual for correct wiring on the CANopen module side.

Modular remote I/O can also be added to GENSYS 2.0 using the CANOPEN© protocol and DB9 connector. For the remote I/O wiring see the figure below.

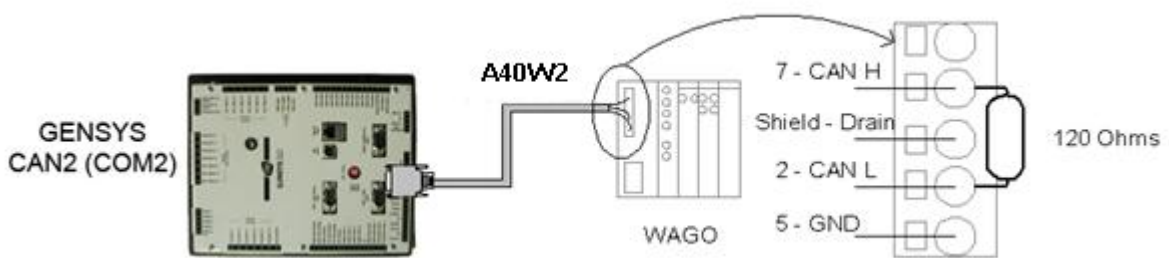

FIGURE 84 - CANOPEN COUPLER WIRING

- CAN L must be connected to pin 2 of the DB9.
- CAN H must be connected to pin 7 of the DB9.
- CAN GND must be connected to pin 5 of the DB9.
- Drain must be connected to the shield of the DB9.

An end resistor of 120 Ω must be connected to each end of the cable between CANH and CANL. This resistor exists inside GENSYS 2.0 and can be activated with a switch accessible from the rear of the unit and located under the plug marked "OFF / 120 Ω ". COM port is marked on the rear. You need to extract the plug

to change the switch. When the switch is ON, resistor is active on bus. When switched the other way, the resistor is not connected to the bus.

Contact your local dealer for a list of recommended CANopen extension modules.

1/ System configuration

CANopen communication uses CANopen messages that can be set up in the “Enhanced configuration/CANopen” menu. GENSYS 2.0 can handle a total of 13 input messages and 19 output messages.

Three parameters must be set for each message to be used. Each message is determined by:

- ❖ The ID of the CANopen extension module (most modules use DIP switches to set their ID).
- ❖ The type of data contained in the message (analogue or digital).
- ❖ The Number of input/output channels in the message.

Note: a CANopen message can handle a maximum of 4 analogue values or 64 digital values.

The total number of CANopen inputs/outputs available is:

- ❖ 44 analogue inputs.
- ❖ 128 digital inputs.
- ❖ 32 analogue outputs.
- ❖ 64 digital outputs.

To ensure proper communication between GENSYS 2.0 and CANopen extension modules, the following rules should be followed:

For a given CANopen module, always group the maximum number of data of the same type in one message. For example, it is better to set up one message with 50 digital inputs than 2 messages with 25 digital inputs each.

Always group messages to/from one CANopen module. For example, do not use output messages 1 and 3 with CANopen module number 1 and message 2 with CANopen module number 2. It is preferable to use messages 1 and 2 with module number 1 and message 3 with module number 2.

CANopen inputs and outputs can be accessed using GENSYS 2.0 variables as described below:

GENSYS 2.0 variable numbers	Description
E0157 to E0284	CANopen digital inputs 1 to 128
E0285 to E0328	CANopen analogue inputs 1 to 44
E2368 to E2431	CANopen digital outputs 1 to 64
E2432 to E2439	CANopen analogue outputs 1 to 8
E2682 to E2689	CANopen analogue outputs 9 to 16
E2708 to E2723	CANopen analogue outputs 17 to 32

TABLE 60 - CANOPEN INPUT AND OUTPUT VARIABLES

The lower variable number is associated to the lower message number configured. The following example will help you understand the relationship between GENSYS 2.0 CANopen variables and physical CANopen I/Os.

2/ CANopen mapping example

In this example, 3 CANopen modules are connected to CAN bus COM2 of GENSYS 2.0. All these modules offer different kinds of input.

CANopen coupler	Physical I/O on the CANopen extensions	CANopen input message setup	Input variables
Coupler ID = 1	4 analogue inputs 4...20mA	Message n°1	E0285
		ID = 1	E0286
		Type = Analogue No. of inputs = 4	E0287 E0288
Coupler ID = 1	2 analogue inputs PT100	Message n°2	E0289
		ID = 1	E0290
		Type = Analogue No. of inputs = 2	
Coupler ID = 1	2 logic inputs	Message n°3	E0157
		ID = 1	E0158
		Type = Logic No. of inputs = 2	
Coupler ID = 2	2 thermocouple analogue inputs	Message n°4	E0291
		ID = 2	E0292
Coupler ID = 2	4 logic inputs	Type = Analogue No. of inputs = 2	
		Message n°5	E0159
		ID = 2	E0160
Coupler ID = 3	10 thermocouple analogue inputs	Type = Logic No. of inputs = 4	E0161 E0162
		Message n°6	E0293
		ID = 3	E0294
		Type = Analogue	E0295
		No. of inputs = 4	E0296
		Message n°7	E0297
		ID = 3	E0298
		Type = Analogue	E0299
No. of inputs = 4	E0300		
Coupler ID = 3	10 thermocouple analogue inputs	Message n°8	E0301
		ID = 3	E0302
Coupler ID = 3	10 thermocouple analogue inputs	Type = Analogue	
		No. of inputs = 2	

TABLE 61 - CANOPEN CONFIGURATION EXAMPLE

17.3.2 COM2: COMMUNICATION J1939

J1939 is a CAN protocol used with modern electronic ECU. It allows reading engine data (oil pressure, water temperature...) and sending commands (start, stop, speed control...).

1/ Setting

In order to use the J1939 communication on the COM2 port:

- Enter in « Configuration/Engine/J1939-MDEC » menu
- In the list, select the manufacturer [E4034].
- Select the ECU type [E4068] according to the manufacturer
- Set the Alarm/fault (See below)
- Connect the CAN bus between the engine ECU and the COM2 port of the GENSYS 2.0 (see §17.1 for more details)

The internal configuration of the module will be directly set according to the manufacturer/ECU pair:

- GENSYS 2 .0 address [E1856]
- ECU address [E1013]
- Oil pressure measure by J1939 or by analogue sensor [E1852]
- Water temperature measure by J1939 or by analogue sensor [E1853]
- Engine speed measure by J1939 or by analogue sensor [E1854]
- Speed control by J1939 or by analogue output
- Start/stop control by J1939 or by the Fuel/Cranck relays

Note: The speed command by J1939 or by analogue sensor depends on ECU. (See below to know the speed control used by default)

After selecting Manufacturer/ECU pair, these parameters can be modified according to your need.

Measure	Value	Description
Oil pressure [E1852]	331	Measure from J1939
	29	Measure from analogue sensor (F8-F9)
Water temperature [E1853]	333	Measure from J1939
	30	Measure from analogue sensor (F6-F7)
Engine speed [E1854]	330	Measure from J1939
	33	Mesure pick-up (G7-G8) or alternator

TABLE 62 - J1939: ANALOG MEASURE OR J1939

Notes:

GENSYS 2.0 can communicate with a large number of J1939 engines. The list is steadily increasing, please contact CRE Technology or your local distributor if your engine is not mentioned in this document.

The speed communication is fixed to 250kbts/s.

Manufacturer [E4034]	ECU [E4068]	Measure by J1939			Control by J1939	
		Oil pressure	Water temperature	Engine speed	Speed	Start/Stop
AUCUN [0]	NA	-	-	-	-	-
SCANIA ⁽¹⁾ [1]	GENERIC [0]	x	x	x	x	x
	DC16-45A [1]	x	x	x	x	x
VOLVO [2]	GENERIC [0]	x	x	x	x	-
	EMS2 [1]	x	x	x	x	x
	EDC4 [2]	x	x	x	x	-
PERKINS [3]	GENERIC [0]	x	x	x	-	-
IVECO ⁽²⁾ [4]	GENERIC [0]	-	x	x	x	-
	NEF [1]	-	x	x	x	-
	CURSOR [2]	-	x	x	x	-
	CURSOR9 [3]	-	x	x	x	-
	CURSOR11 [4]	-	x	x	x	-
GENERIC [5]	NA	x	x	x	x	-
CUSTOM ⁽³⁾ [6]	NA	x	x	x	-	-
CUMMINS ⁽⁴⁾ [7]	GENERIC [0]	x	x	x	x	x
	QSX15-G8 [1]	x	x	x	x	x
	CM850 [2]	x	x	x	-	-
JOHN DEERE [8]	GENERIC [0]	x	x	x	x	-
	JDEC [1]	x	x	x	x	-
CATERPILLAR [9]	GENERIC [0]	x	x	x	-	-
DEUTZ [10]	GENERIC [0]	x	x	x	x	-
	EMR[1]	x	x	x	x	-
	EMR2[2]	x	x	x	x	-
	EMR3[3]	x	x	x	x	-
MTU [11]	GENERIC[0]	x	x	x	-	-
	ADEC-2000 [1]	x	x	x	-	-
	ADEC-4000 [2]	x	x	x	-	-
	MDEC [3]	To configure MTU-MDEC see §17.3.3				

TABLE 63 - J1939: MANUFACTURER/ECU LIST

- (1) By default, the output relay FUEL is inverted for the SCANIA engines. If need the output can be set to initial state by setting the output relay FUEL as « Unused ».
- (2) On IVECO engine, the ECU is powered by the output FULE of the GENSYS 2.0. The output CRANK is activated with a 2 seconds delay (by default) settable by [E4079].
- (3) By selecting CUSTOM engine, you will be able to define manually the frames to send.
- (4) Cummins ECU can contain different firmware depending on their provenance. Cummins CPG (Cummins Power Generation) ECU may not support speed control through J1939. ECU with Cummins G Drive firmware should support the speed control by J1939.

If a J1939 engine is selected, the module is able to read the following information. They are displayed on 5 pages on the « Display/Engine meters » menu.

To get more information on these measures (unit, accuracy...), see the J1939 norm « SAE J1939-71 ».

Measure	PGN ⁽¹⁾	SPN ⁽²⁾	Description
FUEL_RATE [E2833]	0xFE2F	183	Amount of fuel consumed by engine per unit of time.
FUEL_PRESSURE [E2832]	0xFE8B	1390	The absolute pressure at the inlet of the gaseous fuel valve
COOL_FILTER_DIFF [E2881]	0xFE2F	112	Change in coolant pressure, measured across the filter, due to the filter and any accumulation of solid or semisolid matter on or in the filter.
AIR_FILTER_DIFF [E2880]	0xFE2F	107	Change in engine air system pressure, measured across the filter, due to the filter and any accumulation of solid foreign matter on or in the filter.
PARTICULATE_TRAP_INLET [E2879]	0xFE2F	81	Exhaust back pressure as a result of particle accumulation on filter media placed in the exhaust stream
EXHAUST_GAS_TEMP [E2878]	0xFE2F	173	Temperature of combustion by products leaving the engine
AIR_INLET_PRESSURE [E2877]	0xFE2F	106	Absolute air pressure at inlet to intake manifold or air box
CHARGE_AIR_TEMP [E2876]	0xFE2F	105	Temperature of pre-combustion air found in intake manifold of engine air supply system.
BOOST_PRESSURE [E2831]	0xFE2F	102	Gage pressure of air measured downstream on the compressor discharge side of the turbocharger
AMBIENT_AIR_TEMP [E2875]	0xFE2F	171	Temperature of air surrounding vehicle
ATMOSPHERIC_PRESSURE [E2874]	0xFE2F	108	Absolute air pressure of the atmosphere
INLET_TEMPERATURE [E2830]	0xFE2F	172	Temperature of air entering vehicle air induction system
DM1_PROTECT [E2834]	0xFECA	987	Active Diagnostic Trouble Code
DM1_AMBER [E2835]	0xFECA	624	Active Diagnostic Trouble Code
DM1_RED [E2836]	0xFECA	623	Active Diagnostic Trouble Code
DM1_MALFUNCTION [E2837]	0xFECA	1213	Active Diagnostic Trouble Code
COOL_LEVEL [E2873]	0xFEEF	111	Ratio of volume of liquid found in engine cooling system to total cooling system volume
COOL_PRESSURE [E2874]	0xFEEF	109	Gage pressure of liquid found in engine cooling system

Measure	PGN ⁽¹⁾	SPN ⁽²⁾	Description
CRANK_CASE_PRESS [E2882]	0xFEEF	101	Gage pressure inside engine crankcase
OIL_LEVEL [E2871]	0xFEEF	98	Ratio of current volume of engine sump oil to maximum required volume
FUEL_DEL_PRESS [E2870]	0xFEEF	94	Gage pressure of fuel in system as delivered from supply pump to the injection pump
FAULTS [E2869]	0xFECE	1218	Number of fault (DM5)
TOTAL_FUEL [E2868] &[E2867]	0xFEE9	250	Accumulated amount of fuel used during vehicle operation
TRIP_FUEL (E2866) &[E2865]	0xFEE9	182	Fuel consumed during all or part of a journey
TOTAL_FUEL_GASEOUS (E2864) &[E2863]	0xFEAF	1040	Total fuel consumed (trip drive fuel + trip PTO moving fuel + trip PTO nonmoving fuel + trip idle fuel) over the life of the engine
TRIP_FUEL_GASEOUS (E2862) &[E2861]	0xFEAF	1039	Total fuel consumed (trip drive fuel + trip PTO moving fuel + trip PTO non-moving fuel + trip idle fuel) since the last trip reset
BATTERY_POTENTIAL [E2860]	0xFE7	158	Electrical potential measured at the input of the electronic control unit supplied through a switching device
OIL_FILTER_DIFF_PRESS [E2859]	0xFEFC	99	Change in engine oil pressure, measured across the filter, due to the filter and any accumulation of solid or semisolid material on or in the filter.
ENGINE_HOURS [E2858]&[E2857]	0xFEE5	247	Accumulated time of operation of engine
TURBO_OIL_TEMP [E2856]	0xFEEE	176	Temperature of the turbocharger lubricant
OIL_TEMPERATURE [E2829]	0xFEEE	175	Temperature of the engine lubricant
FUEL_TEMPERATURE [E2855]	0xFEEE	174	Temperature of fuel entering injectors
LOAD_C_SPEED [E2854]	0xF004	92	The ratio of actual engine percent torque (indicated) to maximum indicated torque available at the current engine speed, clipped to zero torque during engine braking
ACC_PEDAL_POS [E2853]	0xF003	91	The ratio of actual accelerator pedal position to maximum pedal position. Although it is used as an input to determine powertrain demand, it also provides anticipatory information to transmission and ASR algorithms about driver actions.

Measure	PGN ⁽¹⁾	SPN ⁽²⁾	Description
ACTUAL_TORQUE [E2852]	0xF004	513	The calculated output torque of the engine. The data is transmitted in indicated torque as a percent of reference engine torque
DD_TORQUE [E2851]	0xF004	512	The requested torque output of the engine by the driver. It is based on input from the following requestors external to the powertrain: operator (via the accelerator pedal),cruise control and/or road speed limit governor
MTU_CODE_ERREUR [E2839]	0xFF04	NA	MTU error codes. (not use for protection)

TABLE 64 - J1939: MEASUREMENT LIST

- (1) PGN : Parameter Group Number
(2) SPN : Suspect Parameter Number

In addition of these measures, the module display the last five 5 unknowns SPN/FMI, which have been received by the module with the diagnostic message (DM1). The known SPN are described below in the 1939 Alarm/Message chapter.

These SPN/FMI are backup in the following parameters.

Parameter ⁽¹⁾	Description
J1939 SPN LO 1 [E0852], J1939 SPN HI 1 [E0853], J1939 SPN FMI 1 [E0854]	Last SPN/FMI received by the module.
J1939 SPN LO 2 [E0855], J1939 SPN HI 2 [E0856], J1939 SPN FMI 2 [E0857]	SPN/FMI n°2 received by the module.
J1939 SPN LO 3 [E0858], J1939 SPN HI 3 [E0859], J1939 SPN FMI 3 [E0860]	SPN/FMI n°3 received by the module.
J1939 SPN LO 4 [E0861], J1939 SPN HI 4 [E0862], J1939 SPN FMI 4 [E0863]	SPN/FMI n°4 received by the module.
J1939 SPN LO 5 [E0864], J1939 SPN HI 5 [E0865], J1939 SPN FMI 5 [E0866]	SPN/FMI n°5 received by the module.

TABLE 65 - UNKNOWN SPN/FMI

(1) SPN LO correspond to LSB of SPN, SPN HI correspond to MSB of SPN.

4/ J1939 CAN bus fault

The parameter [E4080] controls the action to perform on a communication fault of the J1939 CAN bus. This parameter is available in level 2 in the « Configuration/J1939-MDEC » menu.

The GENSYS 2.0 is able to monitor diagnostic messages (DM1) from the J1939 engine ECU. Only relevant diagnostic messages are taken into account and used in the GENSYS 2.0 fault/alarm system. GENSYS 2.0 is able to understand and interpret messages for display, process, and protection.

RESET message (DM3) is sent to the engine when internal GENSYS 2.0 RESET is activated ([**RESET**] button or internal variable).

If the diagnostic message is not sent by the J1939 ECU for more than 3 seconds, the corresponding fault/alarm is automatically reset to OFF.

Each of the following J1939 messages/alarms can be configured to serve one of GENSYS 2.0 protections (see §13 for more details on protections).

J1939 Alarm/Message (0 : / 1 : active)	Fault control	Alarm/Message description ⁽¹⁾
High speed [E0332]	CT speed + [E1857]	The engine speed is above the least severe high level threshold set.
Very high speed [E0358]	CT speed ++ [E1862]	The engine speed is above the most severe high level threshold set.
High water temperature [E0343]	CT Cool Temp + [E1859]	The coolant temperature is above the least severe high level threshold set/
Very high water temperature [E0356]	CT Cool Temp++ [E1861]	The coolant temperature is above the most severe high level threshold set.
Low oil pressure [E0339]	CT Oil Press - [E1858]	The oil pressure is below the least severe low level threshold set.
Very low oil pressure [E0355]	CT Oil Press -- [E1860]	The oil pressure is below the most severe low level threshold set.
Malfunction « lamp » [E0359]	CT Malfunction [E1863]	Message used when there is an emission-related trouble code active.
Protection « lamp » [E0363]	CT Protection [E1864]	Message used to relay trouble code information that is reporting a problem with an engine system that is most probably not electronic subsystem related. For instance, engine coolant temperature is exceeding its prescribed temperature range.
Amber « lamp » [E0386]	CT Amber [E1865]	Message used to relay trouble code information that is reporting a problem with the engine system where the engine need not be immediately stopped.
Red « lamp » [E0403]	CT Red [E1866]	Message used to relay trouble code information that is of a severe enough condition that it warrants stopping the engine.

TABLE 66 - J1939: ALARMS/FAULTS LIST

(1) All thresholds are those set in the ECU.

Note: When the J1939 engine has been selected, all control parameters are settable in the « Configuration/Engine/J1939-MDEC » menu.

Rx Custom frames

If you need to get more values from the J1939 device than those available in the basic operations, the system is able to read raw data from 2 different frames you can set to fit your needs.

The following variables are used to define those 2 custom Rx messages: [E2675], [E2676], define the ID of the frames to be monitored. The IDs are those defined by the J1939/71 standards.

The raw data is available as 8 bytes are described in the table below.

Custom RX frame	Variable Frame ID	Frame Raw data variables
1	E2675	E0410 to E0417
2	E2676	E0420 to E0427

TABLE 67 - J1939: TRAMES RX CUSTOM

See J1939-71 standards in order to find the frame ID that fits your needs.

Note : There are no web pages to configure these RX custom frames. Please use custom PLC equations to access custom RX variables. The variables are only accessible by equations.

Tx Custom frames

	<p>WARNING: This feature is designed for experienced user. A wrong configuration could damage your generator.</p>
---	--

If needed, a custom frame can be sent by the GENSYS 2.0 to the J1939 device.

To configure your Tx custom frame, see the frame n°2 configuration of a Custom engine (see below the chapter Custom engine)

Note : There are no web pages to configure these TX custom frames. Please use custom PLC equations to access custom TX variables. The variables are only accessible by equations..

	<p>WARNING: For QSX15-G8 ECU from CUMMINS, it's not possible to use the TX custom frame.</p>
---	---

	WARNING: This feature is designed for experienced user. A wrong configuration could damage your generator.
---	--

When selecting the Custom engine, you can configure 2 frames to send by J1939. Use custom PLC equations to access custom TX variables that are described below.

frame number	Variable	Description
1	[E1856]	GENSYS 2.0 address ⁽¹⁾
	[E2664] to [E2666]	PGN on 3 bytes: [E2664] being the LSB and [E2666] being the MSB.
	[E2662]	Bytes number to send from 0 to 8 bytes. 0 means that the frame is not send.
	[E2667] to [E2674]	Bytes to send. [E2667] being the n°1 byte.
2	[E1856]	GENSYS 2.0 address ⁽¹⁾
	[E2817] to [E2819]	PGN on 3 bytes: [E2817] being the LSB and [E2819] being the MSB.
	[E2820]	Bytes number to send from 0 to 8 bytes. 0 means that the frame is not send.
	[E2821] to [E2828]	Bytes to send. [E2821] being the n°1 byte.

TABLE 68 - J1939: CUSTOM ENGINE CONFIGURATION

(1) From the J1939 norm point of view, this address corresponds to the source address.

17.3.3 COM2: MDEC MTU COMMUNICATION

The MDEC Engine Management System controls and monitors all the functions of MTU 2000 and 4000 Series genset engines. This system includes an Engine Control Unit (ECU), an Engine Monitoring Unit (EMU), a Local Operating Panel (LOP) and engine wiring and sensors.

It incorporates a self-diagnosis system, complemented by a load profile recorder which stores the “service-life data” of the engine in much the same way as a flight recorder.

MDEC also serves as the interface between the engine electronics and the overall generator including gearbox, coupling and alternator.

Note: Selecting MTU MDEC communication prevents you from using extension remote I/O modules.

1/ MDEC configuration

To correctly communicate with GENSYS 2.0, MDEC internal variables have to be configured. The MDEC should be configured as follows to activate the CAN communication:

- ❖ 200 set to 450.
- ❖ 201.01 set to 32.
- ❖ 201.05 set to 201.

For more information on MDEC configuration contact your MTU dealer.

2/ GENSYS 2.0 configuration

To activate the MTU CAN connection enter “Configuration/Engine/J1939-MTU” menu, and select:

- Manufacturer : MTU
- ECU type: MDEC.

Download the custom language. MDEC has labels and codes or numbers which correspond to the MDEC variables:

- ❖ Z090210_2_vxxx.txt corresponds to the English version.
- ❖ Z090210_3_vxxx.txt corresponds to the French version.

Note: vxxx is the corresponding software version of your GENSYS 2.0.

3/ MDEC ↔ GENSYS 2.0 wiring

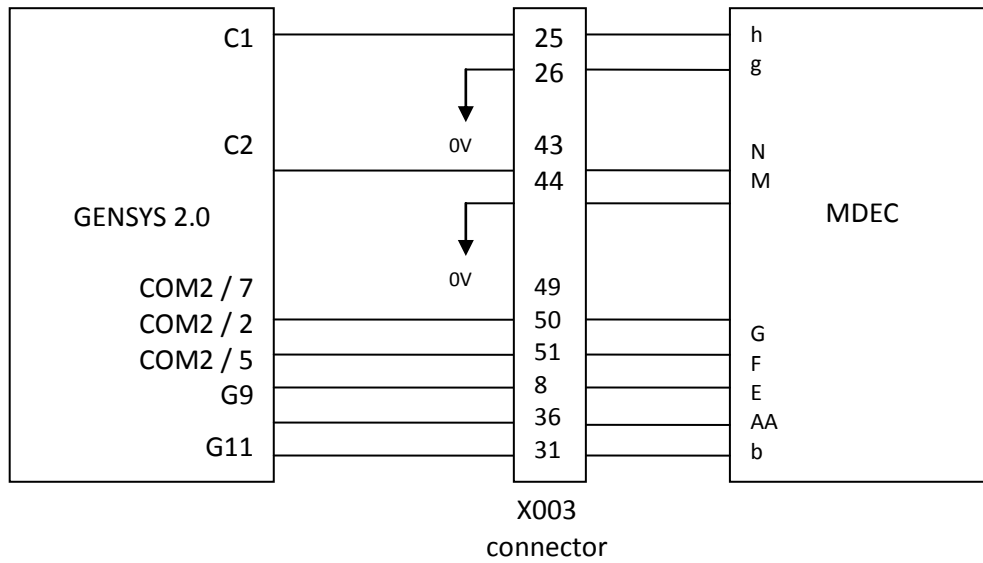

FIGURE 85 - MDEC: GENSYS 2.0 CONNEXION

Label	GENSYS 2.0 terminal	MDEC X1 connector	X003 connector
Digital output to stop request and emergency stop	C1	h	25
		g to ground	26 to ground
Digital output to start request	C2	N	43
		M	44 to ground
CAN High	COM 2 pin 7	G	49
CAN Low	COM 2 pin 2	F	50
CAN ground	COM 2 pin 5	E	51
Analogue speed command	G9	AA	8
Analogue speed reference	G11	b	31 (5V ref)

TABLE 69 - MDEC CONNEXION

Useful GENSYS 2.0 parameters are listed below to ensure proper communication with the MDEC module:

Variable number	Label	Value	Description
V1076	ESG amplitude	50.0	Speed output amplitude to have a trip frequency of +/- 3Hz.
V1077	ESG offset	0.00	Offset to obtain nominal frequency.
V1156	Local language	3	Custom language selected for MDEC labels on the GENSYS 2.0 screen.
V1311	PC language	3	Custom language selected for MDEC labels on your PC.
V1710	User param 001	10	Time to stop request on digital output C1 (1.0 sec. here)
V1711	User param 002	1500	Nominal speed for MDEC through CAN bus.
V1712	User param 003	300	Delay (*100ms) before triggering an MTU CAN bus error. (30 seconds here).
V1852	Branch P-oil	352	The Analogue oil pressure that comes from the MTU CAN bus will be used. ⁽¹⁾

Variable number	Label	Value	Description
V1853	Branch T-water	400	The Analogue water temperature that comes from the MTU CAN bus will be used. ⁽¹⁾
V1854	Branch Speed	331	The Speed measure that comes from the MTU CAN bus will be used. ⁽¹⁾
V1856	MTU CANbusNode	6	Each device on the MTU CAN bus has a node number. GENSYS 2.0 uses have the number 6.
V1857	MTUPV110003 CT	0	Protection control for over speed from MDEC (E0332). ⁽²⁾
V1858	MTUPV110010 CT	3	Protection control for combined alarm yellow from MDEC (E0339). ⁽²⁾
V1859	MTUPV110014 CT	5	Protection control for combined alarm red from MDEC (E0343). ⁽²⁾
V1860	MTUPV110029 CT	0	Protection control for low oil pressure from MDEC (E0355). ⁽²⁾
V1861	MTUPV110030 CT	0	Protection control for very low oil pressure from MDEC (E0356). ⁽²⁾
V1862	MTUPV110047 CT	0	Protection control for low fuel pressure from MDEC (E0358). ⁽²⁾
V1863	MTUPV110048 CT	0	Protection control for very low fuel pressure from MDEC (E0359). ⁽²⁾
V1864	MTUPV110055 CT	0	Protection control for low coolant level from MDEC (E0363). ⁽²⁾
V1865	MTUPV110099 CT	0	Protection control for low coolant level, charge air, from MDEC (E0386). ⁽²⁾
V1866	MTUPV110129 CT	0	Protection control for high coolant temperature from MDEC (E0403). ⁽²⁾
V1867	MTUPV110130 CT	0	Protection control for very high coolant temperature from MDEC (E0404). ⁽²⁾
V1868	MTUPV110133 CT	0	Protection control for high charge air temperature from MDEC (E0407). ⁽²⁾
V1869	MTUPV110143 CT	0	Protection control for high oil temperature from MDEC (E0414). ⁽²⁾
V1870	MTUPV110168 CT	0	Protection control for low charge air temperature from MDEC (E0422). ⁽²⁾
V1871	MTUPV110177 CT	0	Protection control for low engine speed from MDEC (E0426). ⁽²⁾
V4034	Manufacturer	11	Manufacturer selection (MTU)
V4068	ECU type	2	ECU selection (MDEC)

TABLE 70 - IMPORTANT PARAMETERS

(1) The standard sensors required for oil pressure, water temperature and engine speed don't need to be connected to GENSYS 2.0. The value of these 3 analogue inputs (E0029, E0030, E0033) will be taken from the MTU CAN bus.

(2) Control can take the following values:

- 0: disable.
- 1: Generator electrical fault.
- 2: Mains electrical fault.
- 3: Alarm.
- 4: Fault (soft shut down).
- 5: Security (hard shut down).

4/ MDEC variables

The following variables are used to communicate with MTU MDEC devices:

- E0330 to E0484 as input variables (MDEC to GENSYS 2.0).
- E2662 to E2677 as output variables (GENSYS 2.0 to MDEC).

The variables from MDEC can be seen from E0330 to E0484.

The variables that can be written in MDEC are available from E2662 to E2677.

The table in the annexes lists all the variables with correspondences between MDEC and GENSYS 2.0.

5/ Specific screens for MDEC dedicated pages

Engine monitoring can be done via the “Display/Engine meters” menu:

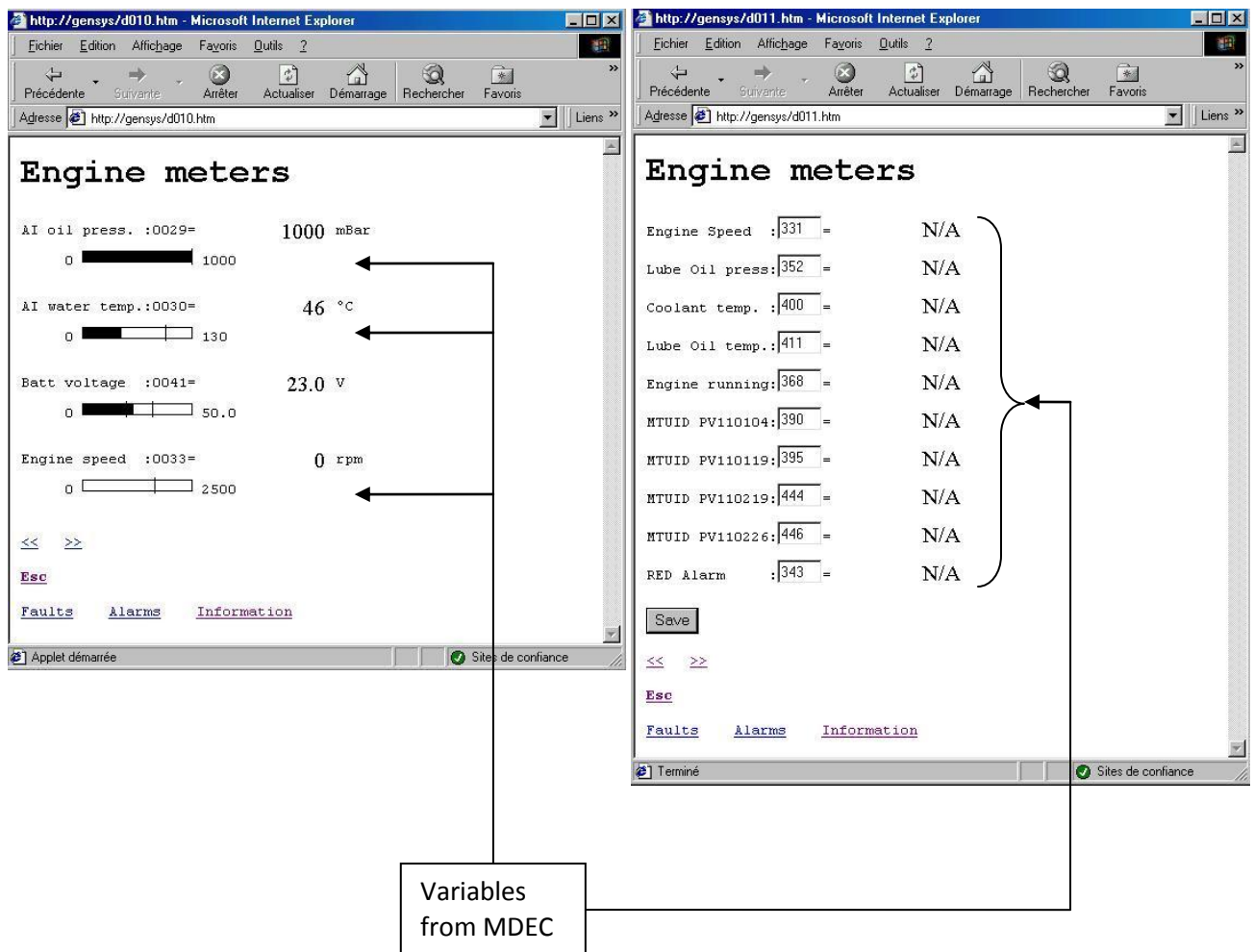

FIGURE 86 - MDEC SCREENS

6/ Additional information

In the standard configuration GENSYS 2.0 can display all the MDEC variables available on the CAN bus thanks to the screen seen above. These variables are displayed ‘as is’ without any further processing, except for certain faults. If you need additional functions related to these variables you will have to program your own PLC equations.

It is also possible to monitor and manage MDEC variables remotely through MODBUS communication on GENSYS 2.0 COM5.

7/ Alarms

The following example will show you how to handle predefined alarms (listed is an example of the predefined alarm seen above).

[E1857] is dedicated to over speed protection from MDEC [E0332]. The equation is the following:

```
TEST (E0332 EQ 1) AND (E1857 NE 0) EQ 1 THEN E2199[E1857]:=1 TEND;
```

[E0332] is the over speed alarm from MDEC.

[E1857] is the control.

If you set [E1857] as security (E1857=5) and [E0332] is set to 1, then [E2204] (hard shut down) will also be set to 1 and trigger the hard shutdown process.

If you want to use an MDEC alarm that is not handled directly by GENSYS 2.0, you can use a virtual input as described in the following example:

If you want to handle an MDEC alarm for "SS Power Reduction Active" [E0338], you can use the virtual input 2 [E2284]. With the CRE config software, set the function [E1329] of the virtual input 2 to "External alarm", and load the following equation in a text file:

```
E2284:=E0338;
```

8/ Fault code numbers.

Combined yellow / red alarms are global warnings. They can be triggered by one of several faults provided on the CAN bus (see list below). Apart from these predefined errors, additional alarm sources are available and can be detected using MDEC fault code numbers.

The MDEC fault code is read by GENSYS 2.0 and stored in MDEC (GENSYS 2.0 variable E0372). If several failures happen together, the fault code variable will be refreshed every second.

This will help you find which alarm is activated in case of a combined alarm.

17.4 COM3: USB

This communication port is no longer used in firmware as from version 2.0. PC connection is now provided via the RJ45 Ethernet communication port.

17.5 COM4: ETHERNET

The Ethernet port features the following communication possibilities:

- ❖ Visualization and configuration of GENSYS 2.0 via its internal Web site, or using CRE Config software (starting from GENSYS 2.0 firmware v3.00).
- ❖ Modbus TCP control of GENSYS 2.0 using SCADA equipment.

17.5.1 MODBUS TCP

To communicate through Modbus TCP, you need to set up the following data on GENSYS 2.0:

- ❖ IP address of the GENSYS 2.0 which can be set up in menu “*System/Communication ports config./COM4(ETHERNET)*”.
- ❖ Modbus TCP port [E4083] which can be set up in the menu “*System/Communication ports config./COM4(ETHERNET)*”.
- ❖ On firmware older than v4.03, also configure Modbus slave identifier [E1634] which can be set up in menu “*System/Communication ports config./COM5(RS485: MODBUS RTU)*”.

Note: The standard Modbus TCP port is 502.



Since firmware v4.03:

- GENSYS 2.0 handles up to 4 Modbus TCP connections with external equipments.
- GENSYS 2.0 handles Modbus RTU over TCP protocol in addition to the more standard Modbus TCP protocol. It is not necessary to select the protocol you want to use: GENSYS 2.0 will detect it automatically and adapt its response to the detected protocol.

For more details on the Ethernet configuration, refer to §6.3.

For more details about supported Modbus functions, refer to §17.6.

17.5.2 COPYRIGHT

GENSYS 2.0 Ethernet communication uses the open source lwIP TCP-IP stack. Please see the copyright/disclaimer below.

More details can be found on lwIP Web site: <http://savannah.nongnu.org/projects/lwip/>

Copyright (c) 2001-2004 Swedish Institute of Computer Science.

All rights reserved.

Redistribution and use in source and binary forms, with or without modification, are permitted provided that the following conditions are met:

1. Redistributions of source code must retain the above copyright notice, this list of conditions and the following disclaimer.
2. Redistributions in binary form must reproduce the above copyright notice, this list of conditions and the following disclaimer in the documentation and/or other materials provided with the distribution.
3. The name of the author may not be used to endorse or promote products derived from this software without specific prior written permission.

THIS SOFTWARE IS PROVIDED BY THE AUTHOR "AS IS" AND ANY EXPRESS OR IMPLIED WARRANTIES, INCLUDING, BUT NOT LIMITED TO, THE IMPLIED WARRANTIES OF MERCHANTABILITY AND FITNESS FOR A PARTICULAR PURPOSE ARE DISCLAIMED. IN NO EVENT SHALL THE AUTHOR BE LIABLE FOR ANY DIRECT, INDIRECT, INCIDENTAL, SPECIAL, EXEMPLARY, OR CONSEQUENTIAL DAMAGES (INCLUDING, BUT NOT LIMITED TO, PROCUREMENT OF SUBSTITUTE GOODS OR SERVICES; LOSS OF USE, DATA, OR PROFITS; OR BUSINESS INTERRUPTION) HOWEVER CAUSED AND ON ANY THEORY OF LIABILITY, WHETHER IN CONTRACT, STRICT LIABILITY, OR TORT (INCLUDING NEGLIGENCE OR OTHERWISE) ARISING IN ANY WAY OUT OF THE USE OF THIS SOFTWARE, EVEN IF ADVISED OF THE POSSIBILITY OF SUCH DAMAGE.

17.6 COM5: MODBUS RTU ON SERIAL PORT RS485

All GENSYS 2.0 internal variables (Measurements, parameters, PLC outputs...) can be monitored remotely through an RS485 communication bus using a MODBUS RTU protocol, GENSYS 2.0 being a MODBUS slave. It is also possible to enter parameters into the GENSYS 2.0. All digital and analogue input/output values and all other parameters which appear in the GENSYS 2.0 menus can be obtained by the serial port RS485, DB9 male COM4. Parameters (E1nnn) are in read only mode (factory setting) but can be individually switched to Read/Write mode using the embedded Web site. Measurements (E0nnn) are Read only, variables E2nnn are in Read/Write mode.



AVERTISSEMENT:

Be careful when modifying a parameter while the engine is running as unexpected behaviour while functioning may damage your generator. It is always advised to change parameters when generator is stopped.

As said above, parameters E1nnn are set to READ ONLY. Write access can be done on a 'per parameter' basis using a configuration text file sent by PC to the GENSYS 2.0. Please refer to §16.3.2 for more details on this Read/Write attribute.

MODBUS functions handled by GENSYS 2.0 are listed in the table below.

Function	Description
01, 02	Reading of logical values (coil status, discrete input status)
03, 04	Read holding/input registers (16 bits)
05	Write logical value (single coil)
06	Preset single register (16 bits variable)
15 (0x0F)	Write multiple logical values (multiple coils)
16 (0x10)	Preset multiple registers

TABLE 71- MODBUS FUNCTIONS HANDLED

Functions 01, 02, 05 and 0F require at least firmware v4.03.



All GENSYS 2.0 variables are 16 bits registers. Yet it might be useful to consider them as logical values (if they are only set to 0 or 1) in order to simplify Modbus communication with some external PLC. If function 01 or 02 is used to read an internal register that is different from 0, then returned value will be 1.

Starting from firmware v4.03, advanced access rights are available:



- Activate/Inhibit Read/Write access individually on Modbus RTU or Modbus TCP communication ports.
 - Write access to date/time/counters. Note that 32 bits variables must be written using function 0x10 only (see table below).
 - Global write access to all configuration parameters.
- ⇒ See chapter 19.4.55/ for more details concerning Modbus access rights.



WARNING:
The autosave is not activated for the Modbus writing. To save the modified parameter by Modbus, see §6.2.2.

32 bits variables	Description
E0025	Generator kWh
E0061	Mains/Bus kWh
E0063	Mains/Bus kVARh
E0065	Engine running hours
E0125	Generator kVARh

TABLE 72: 32 BITS VARIABLES (USE FUNCTION 0X10)

GENSYS 2.0 registers start from address 0. Depending on your MODBUS master equipment and software, you may need to use an offset of 1 when reading/writing registers as addresses may start from address 1. In this case, you will have to request address/register number 1 to access variable E0000 inside your GENSYS 2.0. Refer to document **ZO 90030_xls** to get the complete list of existing variables.

MODBUS communication is setup using menu “System/Serial ports configuration”. Communication parameters are listed in the table below.

Name	Parameter	Description and acceptable values
MODBUS slave address	E1634	MODBUS address of CRE Technology module in the communication bus. This address must be unique and setup between 1 and 247. Note: the module will not accept broadcast requests, <i>i.e.</i> requests with slave address set to 0.
Communication speed	E1441	4800, 9600 or 19200 bauds.
Data bits	N/A	8 (fixed)
Parity	N/A	None (fixed)
Stop bit	N/A	1 bit de stop (fixed)
Response time/Timeout	N/A	Communication timeout should be set to at least 75ms on the MODBUS master.

TABLE 73 - MODBUS CONFIGURATION PARAMETERS

Table below lists the different signals available on COM5 connector.

Terminal	Description
5	B signal
6	A signal
3, 4, 9	MODBUS isolated 0V
1, 2, 7, 8	Not connected

TABLE 74 - COM5 TERMINALS

1/ Useful Modbus registers for easy Alarms/Faults management

In order to lower communication bus load, useful variables exist inside GENSYS 2.0:

- ❖ **Bitfields** variables pack up 16 logic variables inside a single register. This way a single MODBUS request can be used to read useful information.

- ❖ Fault page data. These variables will help you create your own FAULT page in your HMI just the way they appear in your GENSYS 2.0 module. This way you don't have to scan all faults/protections handled by your CRE Technology module.

Note: Data available concerns only faults that appeared after the last power up sequence. Events appeared before GENSYS 2.0 was switched OFF and ON again will be listed in the FAULT pages but not inside those variables.

Table below lists those two kinds of variables.

Variables	Description
E2640...E2649	<i>Bitfields</i> variables. Each variable contains the current value of 16 logic variables such as circuit breaker positions, faults, alarms... Refer to document Z0 90030_ .xls to get the complete list of variables packed inside <i>bitfields</i> .
E0516...E0535	Fault 1 to 20. A negative value indicated that the fault is ON. A positive value indicates that the fault is OFF. A zero means "no data". E0516 is the most recent event listed. Example : E0516 = -2005 means that emergency stop is active (E2005 = emergency stop). E0516 = 2005 means that emergency stop has been released.
E0821...E0850	Fault 21 to 50. A negative value indicated that the fault is ON. A positive value indicates that the fault is OFF. A zero means "no data". E0850 is the most ancient event listed. Example : E0842 = -2005 means that emergency stop is active (E2005 = emergency stop). E0842 = 2005 means that emergency stop has been released.

TABLE 75 - MODBUS PARAMETERS FOR ALARM/FAULT MANAGEMENT

2/ Sharing digital input and Modbus control over a single function

If you need to control a specific function (for example REMOTE START E2514) both using Modbus and logic inputs, please follow instructions as described in the example below to avoid conflicts between logic inputs and Modbus write accesses. In this example, remote start E2514 is controlled both by input J8 and through Modbus access. This means that both can start the generating set. To do so, a virtual input (here Virtual input 1 E2283) is setup the same way as input J8 and is then controlled through Modbus.

- Set parameter E1269 "DIJ8 function" to 2514.
 - Set parameter E1328 "VI01 function" to 2514.
 - Write 1 or 0 into E2283 ("Virtual in 01") using Modbus to set virtual input to the desired value.
- ⇒ This way, both physical input J8 and virtual input 1 are considered as inputs controlling variable E2514.

3/ *Modbus communication example:*

Table below gives an example of a MODBUS master sending a reading request (function 04) of 3 registers starting from variable E0007. This request is sent to a GENSYS 2.0 setup as slave number 5.

MODBUS RTU request/answer example			
Master request		GENSYS 2.0 slave answer	
Field	Value	Field	Value
Slave address	05	Slave address	05
Function request	04	Function	04
Starting register (MSB)	00	Data bytes (=2*Number of requested registers)	06
Starting register (LSB)	07	Value of register E0007 (MSB)	D0
Number of registers (MSB)	00	Value of register E0007 (LSB)	D1
Number of registers (MSB)	03	Value of register E0008 (MSB)	D2
CRC16 (MSB)	00	Value of register E0008 (LSB)	D3
CRC16 (LSB)	4E	Value of register E0009 (MSB)	D4
		Value of register E0009 (LSB)	D5
		CRC16 (MSB)	XX
		CRC16 (LSB)	YY

TABLE 76 - MODBUS COMMUNICATION EXAMPLE

17.7 COM6: SD CARD

GENSYS 2.0 is equipped with a SD card slot that adds different functions using a FLASH memory SD card.

- Data logger
- Firmware upgrade
- Import/Export a text file

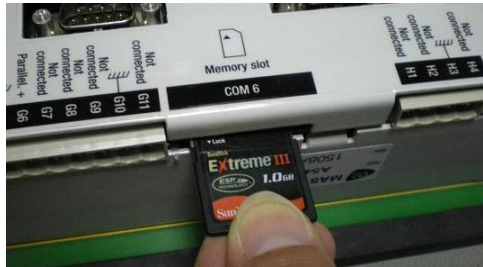

Table below details what kind of SD card can be used depending on firmware version installed into your module. To check your firmware version, go into menu « **System / About** » or « **System / Serial number/Soft version** ».

Supported cards and file systems depending on firmware version	
	<p>Firmware versions 4.00 and above can accept SD and SDHC cards formatted using FAT16 or FAT32 file systems.</p>
	<p>Firmwares older than v4.00 only accept SD cards up to 2 GB formatted using FAT16 file system.</p> <p>High capacity SDHC cards (cards above 2 GB) and cards formatted using FAT32 file system are not supported.</p> <div style="display: flex; justify-content: space-around; align-items: center;"> <div data-bbox="438 1339 802 1626"> </div> <div data-bbox="802 1339 1166 1626"> </div> <div data-bbox="1166 1473 1396 1626"> </div> </div>

17.7.1 DATA LOGGER USING SD CARDS

The SD card must contain a file named **logger.csv**. CSV (*Comma separated value*) is a computer file format which shows tables in the form of values separated by commas or semi-colons.

This file can be created using Microsoft Excel or the notepad: open the notepad, then write the names of the variables you wish to save (max 25) using the Exxxx format. Separate each variable with a comma and save the file as logger.csv.

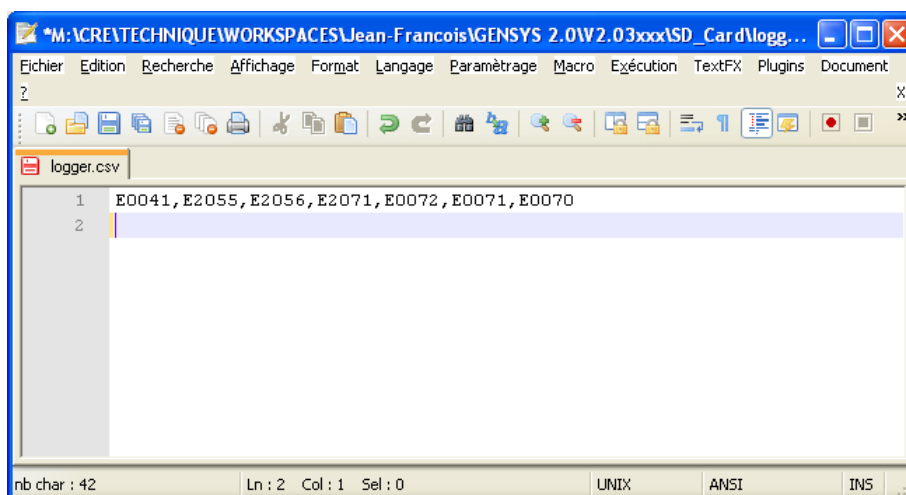
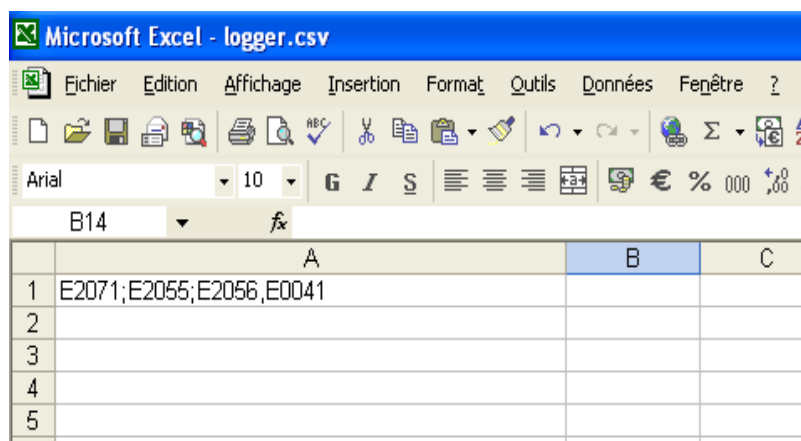

Variable [E4041] allows you to choose the recording time in seconds. As soon as the SD card is inserted into the GENSYS 2.0, the recording will start every [E4041] seconds.

Every [E4041] seconds, all the variables entered in the first line of the logger.csv file will be saved to the file.

Note: If the variable [E4041] is set to 0, the recording stops.

NOTE

Do not remove the SD card from its slot when it is being accessed by GENSYS 2.0 or it may corrupt your file. To avoid damaging data, make sure to:

- Set parameter [E4041] to 0 in order to stop data logging on SD card.
- Check that top right LED of the front panel (picture below) is turned off.



⇒ You can now safely remove your SD card from its slot.

To view the archive, open the logger.csv file using Excel. Each line of recording is date marked.

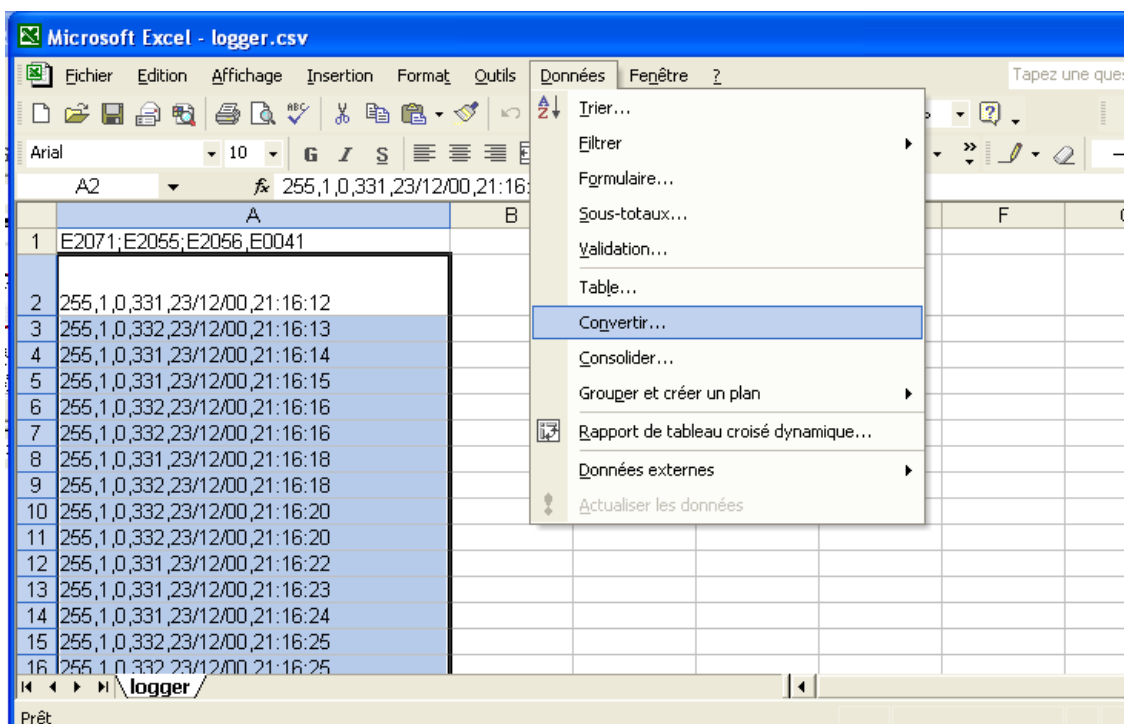

- ❖ Select the first column (A) with saved values.
- ❖ Click on "Data", then "convert".
- ❖ Select "limited".
- ❖ Select Table, Comma and Semicolon. Click "Next".

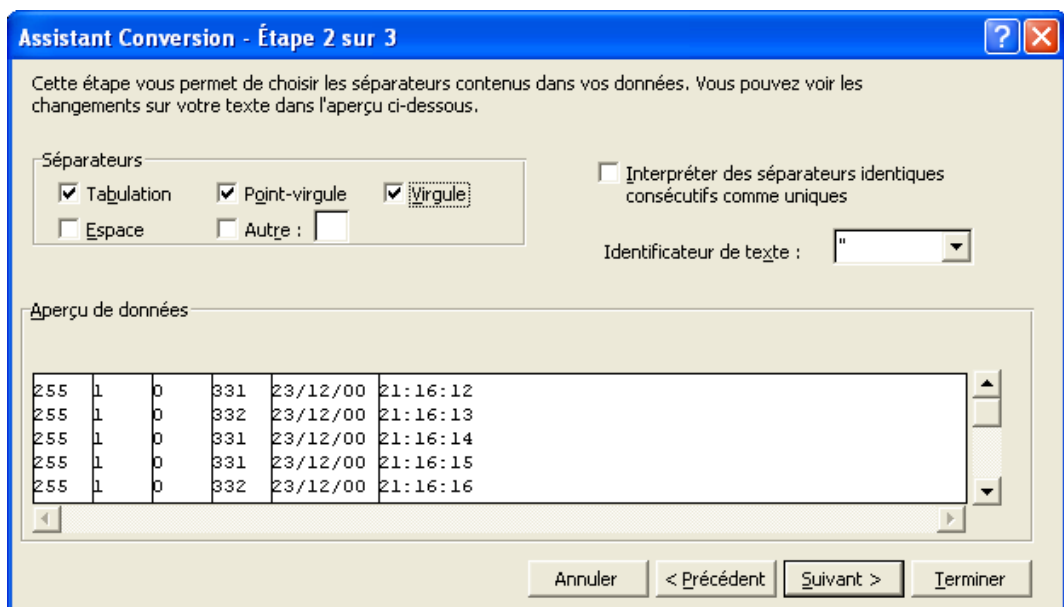

The variables, values, dates and times are now laid out in columns.

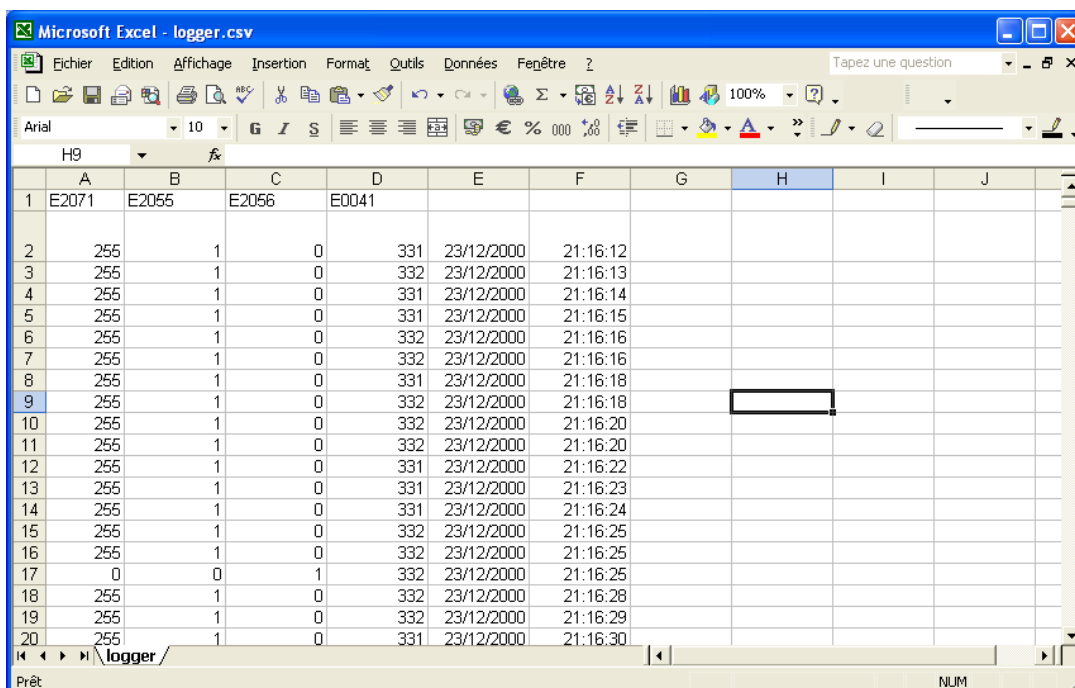

The backup file size is computed from the following equation :

$$\text{file size} = \frac{(3 \times \text{number of variables} + 12) \times \text{recording time in second}}{\text{Recording period in second}} \text{ bytes}$$

Here some file size examples.

Number of variable	Recording time	Recording period	File size
5	8h	1s	780kbytes
25	24h	5s	1,5Mbytes
5	5min	1s	8,1kbytes
25	30 days	10s	22,5Mbytes

TABLE 77 - SD CARD BACKUP - FILE SIZE

17.7.2 FIRMWARE UPGRADE USING SD CARD



Starting from firmware v3.00, it is now possible to upgrade the firmware with a new version using a computer, the embedded Web site and an SD card. This way you can add new software functions to your module.

Notes:

Programming a new firmware in your module will erase its actual setup (parameters, equations, custom texts...) and replace it by the factory setup of the new firmware. Save your actual setup if you want to keep it for future usage. Only software options will be kept in memory during firmware upgrade process.

Parameter [E1929] (Phase Offset – Option 8) will be reset (as all other parameters) during upgrade process. Set it back to the desired value if needed (use of Dyn11 transformer for example).

WARNING :



- Always disconnect your module from other CRE Technology products when upgrading firmware (disconnect it from the inter-GENSYS CAN bus). It is advised to disconnect all connectors from your module (except power and Ethernet) during upgrade process.
- After upgrading, enter the proper module number in your product before connecting it to the inter-GENSYS CAN bus. Otherwise, other modules may behave abnormally.
- Do not upgrade firmware on a running product.



ATTENTION: Boot firmware v2.xx and v3.xx do not support high capacity SDHC cards (cards above 2 GB) or cards formatted using FAT32. Only use FAT16 SD cards up to 2 GB on boot firmware v2.xx and v3.xx. Boot firmware v4.00 and above accept FAT32 SDHC cards. To check your boot version, go into menu “System/About”.

To upgrade your module firmware, please follow those steps:

- ❖ Connect your PC to the module internal Web site using password level 2.
- ❖ Backup parameters and equations if necessary.
- ❖ Copy the new firmware on an SD card and insert it into the module. Filename must respect format XXXXXXXX.H86 and the file should be provided exclusively by CRE Technology or its distributor network.
- ❖ Go into menu « System/Firmware upgrade ».
- ❖ Click on « List files ».
- ❖ Select the file you want to program into the module.
- ❖ Click on « Upgrade firmware ».

Moteur arrete uniquement, une mise a jour peut prendre jusqu'a 5mn, ne pas couper l'alimentation.

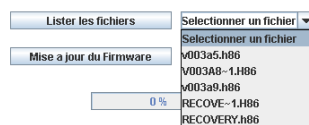

[Esc](#)

[Defaults](#) [Alarmer](#) [Information](#) [Shift + I](#)

A bar graph indicates the progress of the process.

Moteur arrete uniquement, une mise a jour peut prendre jusqu'a 5mn, ne pas couper l'alimentation.

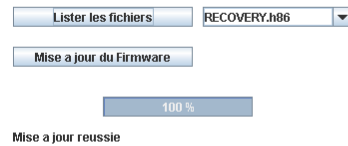

[Esc](#)

[Defaults](#) [Alarmes](#) [Information](#) [Shift + I](#)

Note: If your module was setup for DHCP usage on Ethernet, bar graph will stop at 97% even if firmware was successfully upgraded. Factory parameters inside the new firmware set up the Ethernet to use a fixed IP address, so this disconnects communication between the module and your computer. You can reset communication by setting back DHCP configuration for example using the module front panel:

-Activate DHCP in menu « System/Communication ports config. /COM4 (ETHERNET) ».

-Switch your module OFF and ON again to initiate DHCP communication.

Otherwise, please see §6.3 in this documentation to setup your computer for communication with factory setup modules.

17.7.3 EXPORT/IMPORT A TXT FILE ON SD CARD



These functions are featured starting from firmware v3.00.

1/ *Export a text file to SD card*

Exporting a TXT file gives you the ability to save parameters and equations of your module into an SD card. Exporting a TXT file can be done either from the front panel or from the embedded Web site. Go into menu « System/Communication ports config./COM6(SD CARD)/Module -> SD », then select “Yes” and click on “Save” button.

Exported file name will be in the form of PARAM00x.TXT. Exact name will be displayed on the screen. The filename will use the smallest value available. If none is available, then existing file will be replaced.

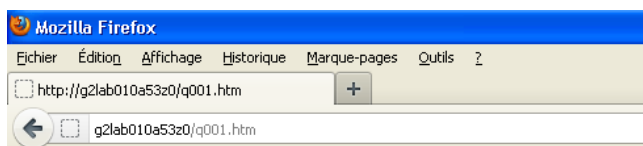

Module -> SD

Download text file ?

No

Esc

[Faults](#) [Alarms](#) [Information](#) [Save modified parameters](#)

Note: Exported content depends on the actual password level. If you entered password level 1, custom level 2 equations that may be running inside your module will not be exported into the TXT file.

2/ Import a text file from SD card

This feature gives you the ability to load parameters and equations from a file on an SD card into your CRE Technology module. Importing TXT file can be done either from front panel or from the embedded Web site using menu « System/Communication ports config./COM6(SD CARD)/SD -> Module ».

File to be loaded must have a name respecting format PARAM00x.TXT⁽¹⁾. Select the file of your choice and click on « Save » button.

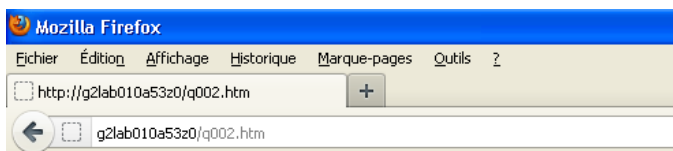

SD -> Module

Upload text file:

PARAM001.TXT

Esc

[Faults](#) [Alarms](#) [Information](#) [Save modified parameters](#)



WARNING:

For safety reasons, parameter E1929 (Phase offset – Used for example with Dyn11 transformers) will not be changed when importing a text file. This parameter must be adjusted manually.

Note: Imported content depends on the actual password level. If you entered password level 1, custom level 2 equations that may be in the TXT file will not be imported.

18 SUPPORT/TROUBLESHOOTING

GENSYS 2.0 displays a "sensor lost" fault when starting

In "Configuration/Engine/Speed control settings" menu, check that the speed measure configuration is consistent with your system. (Speed measure [E1078] = Magnetic or Alternator).

Check the voltage presence on terminal B1 to B4 (if speed measure by Alternator).

Check the engine speed increase until 1500rpm (If speed measure by Magnetic sensor)

If you don't have these values and engine stops in time, increase the "sensor lost" timer [E1458] (default value 10 sec.) This timer is available in level 2 in "Configuration/Timers/Engine » menu.

GENSYS 2.0 displays oil pressure fault or not ready when starting

Check the connection between the J4 terminal and the oil pressure contact.

Check that the configuration of this sensor is correct in « Configuration/Inputs/Digital inputs ». It means that the DIJ4 function [E1996] must be set on 'Oil pressure fault' if it's a standard pressure sensor (Enable/Close when the engine is stop)

Some LEDs blink when GENSYS 2.0 is powered

If some LEDs blink (3 vertical LEDs on the left, horizontal LEDs, 3 vertical LEDs on the right), the unit detects a problem because of a wrong operation. The GENSYS 2.0 must be returned to CRE Technology or your local distributor.

GENSYS 2.0 displays a "GENSYS CAN Bus" fault

If the fault appears during parameter backup, check the connection between GENSYS 2.0 units.

Check the number of units available and their ID CAN number in the "Display/Power plant overview" menu

Note: Each GENSYS 2.0 must have a different ID CAN number.

Check the CAN bus wiring (end of line resistor, in the wire or on the GENSYS 2.0).

GENSYS 2.0 displays "breaker failure"

Check that control switch is in manual mode.

Check that J2 (back breaker) is activated. If this entry did not have time to activate, you can increase the [E1149] variable delay (by default: 5.0s).

This fault can occur if the opening of the circuit breaker has not been controlled by the GENSYS 2.0. Check if another module is able to control the circuit breaker.

The engine starts but runs above/below nominal speed.

Check the wiring (Same 0V connection between GENSYS 2.0 and the governor)

Check the fuel supply

Check the speed output:

This output (G9-G11) is used to interface with the speed governor. The target is to bias the speed/fuel rack for synchronizing, load sharing, ramping load up and down. This output, only alters the power (kW), can be set by parameters [E1077] (Offset) and [E1076] (Gain).

When connecting this output you must know the details of the input you are using. For example a Woodward 2301A uses ± 2.5 Volts input around 0V.

Thus the span to achieve the required span (± 2.5 Hz) is ± 2.5 Volts, therefore the settings are:

- Gain [E1076]=25% (+/-2,5Vdc)
- Offset [E1077]=0% (0V).

It's important to do the first starting without connect the GENSYS 2.0 speed output in order to be sure that the engine running at 50Hz. If it's not the case, the speed governor control must be set correctly.

For the entire settings of the GENSYS 2.0 → Speed governor, see §11.1.1.

When you power up the GENSYS 2.0, the display does not work

Check the jumper situated under the plastic cap near the logo on back cover is removed or in OFF position. If not, remove power supply to remove this jumper or set it to OFF position.

If there is no change, the module is defective and needs to be returned to CRE Technology.

If fault occurs while testing speed or voltage

Check the connection of 0V signals.

In J1939, the communication doesn't works

- Check that the ECU is powered.
- Check that the configuration correspond to the engine/ECU.
- Check that the J1939 (or MDEC) address is correct (Contact the manufacturer if it's not a standard address).
- Check that the wiring is correct (GENSYS 2.0 COM2 to ECU by J1939) and 120 Ω resistors in end of line are set.
- Switch off power supply (GENSYS 2.0 and ECU) and switch on in order to reset the communication.
- Check that the configuration of the ECU and the ECU unit are consistent with the J1939 norm.

Note: Some ECU doesn't give information if the engine is stop. Start the engine to display engine data.

kW load sharing is bad

- Check the wiring direction of the current transformers and the power measurements (“Display/Generator electrical meter/Global view generator” menu). The power by phase must be balanced and positive.
- Check the speed control is correctly configured and performs the same action on all speed governors.
- Check that all engines are stable. If one or more engines oscillate in frequency (even slightly), this oscillation will affect the load sharing.
- Adjust the kW load sharing gain (« Configuration/Control loops/kW control/kW load sharing” menu)

The breaker control doesn't work correctly

- Check that the breaker output correspond to the equipment used. (“Configuration/Outputs/Breakers” menu)
- Check the breaker wiring.
- Check the timers associate to the breaker control. (See §11.4.1)

19 MENU OVERVIEW

19.1 MENU INTRODUCTION

Menu is entered when [ESC] key is pressed, and once password has been verified. The password will define which menu will be accessible:

Level 0: will give access to display menu only. (Without password, only press Enter/Enter)

Level 1: will give access to all menus and level 1 equation.

Level 2: will give access to all menus, level 2 equations and to some advance functions

3 main menus are available:

Display will give information about the generating set, bus-bar or mains, and will display real time information and parameters status.

Configuration is only accessible if you have entered a level 1 or 2 password. You will be able to program GENSYS 2.0 according to the needs of your plant.

System is only accessible if you have entered a level 1 or 2 password. The system menu will let you change parameters that are not related to the plant, but rather to the GENSYS 2.0 system. (Date/Hour, languages, communication port interface...)

19.2 DISPLAY MENU

This menu gives access to the following information:

- Power plant overview (level 1 & 2)
- Generator electrical meter
- Mains/Bus electrical meter
- Synchronization
- Engine meters
- Inputs/outputs state
- Active timers (level 1 & 2)
- Maintenance cycle monitoring (level 1 & 2)
- About (only level 0))
- Data logging (only on PC)

19.2.1 POWER PLANT OVERVIEW

This menu displays the power plant parameters (parameters shared by up to 32 different GENSYS 2.0 and/or MASTER 2.0 units):

1/ *Power plant status*

This screen displays the machine status [E2071] of each generating set.

2/ *GE 01 to 16 - kW*

This screen displays the percentage of nominal active power supplied by each generating set (from 1 to 16) in real time the [E0042 à E0057]

3/ *GE 17 to 32 - kW*

This screen displays the percentage of nominal active power supplied by each generating set (from 17 to 32) in real time the [E6000-E6030-E6060 ... E6450]

4/ *GE 01 to 16 – kVAR*

This screen displays the percentage of nominal reactive power supplied by each generating set (from 1 to 16) in real time [E0132 to E0147]

5/ *GE 17 to 32 – kVAR*

This screen displays the percentage of nominal reactive power supplied by each generating set (from 17 to 32) in real time [E6001-E6031-E6061 ... E6451]

6/ *GE 01 to 16- nominal kW*

This screen displays the nominal active power of each generating set from 1 to 16 [E0073 to E0088]

7/ *GE 17 to 32- nominal kW*

This screen displays the nominal active power of each generating set from 17 to 32. [E6003-E6033-E6063... E6453]

8/ *GE 01 to 16- nominal kVAR*

This screen displays the nominal reactive power of each generating set from 1 to 16 [E0089 à E0104]

9/ *GE 17 to 32- nominal kVAR*

This screen displays the nominal reactive power of each generating set from 17 to 32 [E6004-E6034-E6064 ... E6454]

Note: These display pages fit according to the number of unit selected

19.2.2 GENERATOR ELECTRICAL METER

1/ Global view generator

This screen displays all generator electrical meter in real time:

- **Phase to phase voltage** for each phase [E0003, E0004, E0005]
- **Phase to neutral voltage** for each phase [E0000, E0001, E0002]
- **Current** for each phase [E0006, E0007, E0008]
- **Active power** for each phase [E0009, E0010, E0011]
- **Reactive power** for each phase [E0012, E0013, E0014]
- **Power factor** for each phase [E0015, E0016, E0017]
- **Average active and reactive power, frequency and power factor** [E0018, E0019, E0020, E0021]

2/ Generator phase -phase volt

This screen displays the three phase to phase voltage measurements.

3/ Generator phase-neutral volt

This screen displays the three phase to neutral voltage measurements.

4/ Generator currents

This screen displays the three current measurements.

5/ Generator kW

This screen displays the three kW measurements.

6/ Generator kVAR

This screen displays the three kVAR measurements.

7/ Generator PF

This screen displays the three power factor measurements.

8/ Generator parameters

This screen displays generator average active and reactive power, frequency and power factor measurements.

9/ Generator energy meters

This screen displays KWh and kVARh calculation.

Note: These display pages fit according to the voltage system selected (see §14.15)

19.2.3 MAINS / BUS BARS ELECTRICAL METERS

1/ Global view Mains/Bus

This screen displays all Mains/Bus electrical meter in real time:

- **Phase to phase voltage** for each phase [E0796, E0797, E0798]
- **Phase to neutral voltage** for each phase [E0793, E0794, E0795]
- **Current** for each phase [E0799, E0800, E0801]
- **Active power** for each phase [E0802, E0803, E0804]
- **Reactive power** for each phase [E0805, E0806, E0807]
- **Power factor** for each phase [E0808, E0809, E0810]
- **Average active and reactive power, frequency and power factor** [E0060, E0059, E0023, E0058]

2/ Mains/Bus phase-phase volt

This screen displays the three phase to phase voltage measurements.

3/ Mains/Bus phase neutral volt

This screen displays the three phase to neutral voltage measurements.

4/ Mains/Bus currents

This screen displays the three current measurements.

5/ Mains/Bus kW

This screen displays the three kW measurements.

6/ Mains/Bus kVAR

This screen displays the three kVAR measurements.

7/ Mains/Bus PF

This screen displays the three power factor measurements.

8/ Mains/Bus parameters

This screen displays Mains/Bus average active and reactive power, frequency and power factor measurements.

9/ Mains/Bus parameters

This screen displays kWh and kVARh measurements.

10/ Mains/Bus energy meters

This screen displays kWh and kVARh measurements.

Note: These display pages fit according to the voltage system selected (see §14.15)

19.2.4 SYNCHRONIZATION

This page displays:

- ❖ Synchroscope (phase difference)
- ❖ Differential frequency (bar graph)
- ❖ Differential voltage (bar graph).
- ❖ Synch check relay status (Phase difference, frequency difference, voltage difference, phase sequence).
- ❖ Phase Offset (shows the parameter [E1929] set for the phase angle shift).

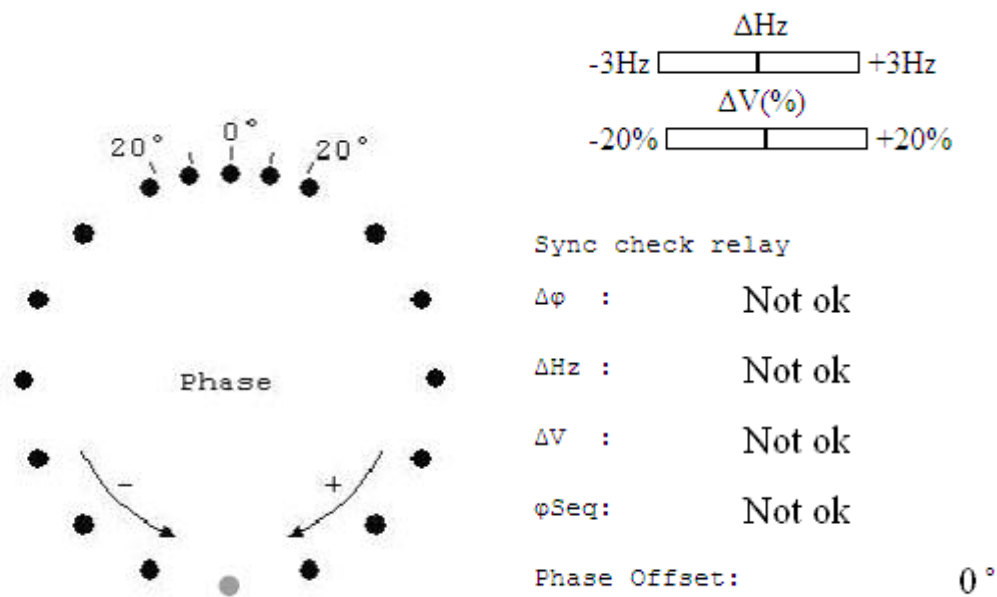

FIGURE 87 - SYNCHROSCOPE

19.2.5 ENGINE METERS

These measurements provide information about the engine.

- Oil pressure [E0029]
- Water temperature [E0030]
- Engine speed [E0033]
- Battery voltage [E0040]
- two spare analogue resistive sensors: [E0031], [E0032]
- Hours and minutes run meter [E0065], [E0891]
- Total number of starts [E0041],
- User meters 1 & 2 [E2657], [E2659]

Note: The oil pressure, water temperature and speed engine can be measure by an analog input/pick-up or by J1939 (see §17.3.2 for more details)

If the unit is connected by J1939 to the engine, some extra pages are available in order to display the measurement received from the engine. (See §17.3.2 for more details)

19.2.6 INPUTS/OUTPUTS STATE

1/ Digital inputs 0-7

This menu shows the status of the “Emergency stop” input [E2005] as the status of the 7 first digital inputs connected on the “J” terminal. [E2000, E2001, E2804 à E2807].

The name of each input is displayed with the status: Input active =1, Input inactive = 0.

2/ Digital inputs 8-15

This menu shows the status of 8 digital inputs connected on the “J” terminal. [E2808 to E2815].

The name of each input is displayed with the status: Input active =1, Input inactive = 0.

3/ Relay outputs

This menu shows the status of the 4 relay outputs:

- Generator breaker [E2016]
- Mains breaker [E2017]
- Relay A1 [E2018]
- Relay A2 [E2019]

The name of each input is displayed with the status: Input active =1, Input inactive = 0.

Note: By default, relay A1 corresponds to crank relay and relay A2 corresponds to fuel relay.

4/ Digital outputs

This menu shows the status of 5 digital outputs connected on the "C" terminal [E2020 à E2024].

The name of each output is displayed with the status: Input active =1, Input inactive = 0.

19.2.7 ACTIVE TIMERS

This menu shows the timer values running in real time on 2 pages. To change timer values, you should go to « Configuration/Timers » (See §19.3.9).

1/ Timers 1/2

Parameter [var.num]	comment
Crank timer [E2060]	Shows the time before crank relay is energized
Warm up timer [E2061]	Shows the time generating set has to wait to warm up before taking the load.
Speed stab [E2062]	Shows the time generating set has to wait to allow engine speed stabilization before taking the load.
Volt stab [E2063]	Shows the time the generating set has to wait to allow voltage stabilization of the engine before taking the load.
Cooling timer [E2064]	Shows the time the generating set has to run without load before stopping the engine.
Fail to stop [E2065]	Shows the time of the current stop sequence. If engine does not stop when this timer

Parameter [var.num]	comment
Stop rest time [E2066]	Shows the time the engine has been waiting since being put at rest.
Crank rest [E2067]	Shows the time between crank attempts.
Prelub timer [E2084]	Shows the pre-lubrication time before cranking.
Preglow timer [E2083]	Shows the preheating time before cranking.

TABLE 78 - ACTIVE TIMERS 1/2

2/ Timers 2/2

Parameter [var.num]	comment
TM extc restrt [E2256]	Shows the time before giving the AVR a command to supply excitation after a generator electrical fault.
Mains br fault [E2073]	Shows the time GENSYS 2.0 must wait after a start before having any action on mains breaker.
GE brk fault [E2074]	Shows the time GENSYS 2.0 must wait after a start before having any action on generating set breaker.
Fail to synchr [E2075]	When synchronizing in auto mode, this timer defines the time to determine if synchronization has failed.
Ramp up timer [E2081]	Shows the time to take the load with a load ramp.
Ramp dwn timer [E2082]	Shows the time to lose the load with an unload ramp.
Bef power down [E2239]	Shows the time to stop other generating set when low load level is reached (See §14.13).
Bef power up [E2240]	Shows the time to start other generating set when high load level is reached (See §14.13).
MA back timer [E2091]	In changeover configuration, shows the time to wait when mains returns.

TABLE 79 - ACTIVE TIMERS 2/2

19.2.8 MAINTENANCE CYCLE MONITORING

This menu display the maintenance cycle monitoring that has been configured (see §14.16)

19.2.9 ABOUT

This screen is only display with the level 0 password. It's the same menu than « System/About » available with the level 1 password. (See §19.4.11)

19.2.10 DATA LOGGING

This menu is only available on web site.

5 pages will show the **FIFO event data logger** selected in the data logger configuration page. (See §19.3.12)

You can download the **summary file** with a computer connection. (See §19.4.6)

19.3 CONFIGURATION MENU

This menu allows configuring the unit. You can access to this menu with the level 1 or 2 password.

The submenus are the followings:

- Power plant
- Power management system
- Generator
- Mains/Bus
- Engine
- Protections
- Inputs
- Outputs
- Timers
- Synchronization
- Control loops
- FIFO data logger
- Modification by variable n°

19.3.1 POWER PLANT

Parameter [var.num]	Possible value	Comment
My number [E1179]	1 to 32	Number given to this particular GENSYS 2.0 on the power plant.
Quantit.GENSYS [E1147]	1 to 32	Total number of GENSYS 2.0 installed on the power plant.
Quantit.MASTER [E4006]	0 to 32	Is the total number of MASTER 2.0 (Mains control modules) installed on the power plant.
Mains parallel [E1148]	ChangeOver [0]	On Mains failure, engine starts and takes the load by opening mains breaker and closing generating set breaker with interlocking. On mains return, unload generating set by opening generating set breaker and closing mains breaker with interlocking, and stop engine.
	NoBreak CO [1]	Only available with <i>mains paralleling</i> option. Same as changeover mode but loading/unloading is made without black, with ramps after synchronization with mains.
	Permanent [2]	Only available with <i>mains paralleling</i> option after a start demand, GENSYS 2.0 will synchronize generating set to mains and keep both breakers closed.
	No ch.over [3]	GENSYS 2.0 must receive a start demand and will not manage mains breaker output. There will be no synchronization with the bus bar or the mains.
Load sharing [E1158]	Analog[0]	Load sharing will be done via analog bus (pins G4 and G6).
	CAN bus[1]	Load sharing will be done via inter GENSYS digital CAN bus (COM 2 port).
Mains regul. [E1153]	Peak shav.[1]	GENSYS 2.0 will permanently vary generating set power to maintain constant power supply from mains.
	Base load[2]	GENSYS 2.0 will permanently maintain constant generating set power.
Static parallel [E1177] ⁽¹⁾	No[0]	Standard synchronization: will be carried out by adjusting engine speed and generator voltage.
	Yes[1]	Breakers are closed before engine starting and generator excitation.
Deadbus manag. [E1515]	Yes[0]	Dead bus management will be done via inter GENSYS digital CAN bus (COM2 port).
	No[1]	External logic controls dead bus management.
Voltage schema [E4039]	Triphase 120° [0]	Voltage system selection (See §14.15 for more details)
	Biphase 180° [1]	
	Monophase [3]	

TABLE 80 - POWER PLANT CONFIGURATION

(1) Only available on level 2

19.3.2 POWER MANAGEMENT SYSTEM

Load dependant start/stop

This menu allows to set the parameters concerning automatic start/stop of generating sets according to the load as described in §14.13.

Parameter [var.num]	Possible value	Comment
S/S ctrl mode [E1258]	[0] Inhibited	No automatic start/stop of generating sets according to the load of the power plant.
	[1] GE number	Engines will start/stop according to their generating set number
	[2] Hours run	Engines will start/stop according to the GENSYS 2.0 running hour meter.
	[3] Var. E1617 ⁽¹⁾	Engines will start/stop according to the value of parameter E1617. E1617 value should be different on each GENSYS 2.0.
Optimised ctrl [E1914]	[0] No [1] Yes	[0] Engine stops if the global load of the plant is below the stop threshold. [1] Engine stops if the remaining generating sets are not going to be loaded over the optimal load level.
Start threshold [E1256]		Percentage of load on the power plant above which another engine will be requested to start and share the load.
Stop threshold [E1254]		Percentage of load on the power plant under which an engine will be stopped. Used when E1914=0.
Optim.load [E1915]		Optimal load level limit for running engines. Used when E1914=1.
TM bef. start [E1257]		Percentage of the generating set nominal power at which GENSYS 2.0 will ask a generating set to stop sharing the load.
TM bef. stop [E1255]		Delay before deciding to reduce the number of generating sets in load/unload management.

TABLE 81 - LOAD DEPENDANT START/STOP CONFIGURATION

(1) Only available on level 2

This menu is only available in modules from the MARINE range.

This menu allows the setup of parameters used for the management of heavy consumers as described in chapter 14.13.

Parameter [var.num]	Possible value	Comment
Authorize on [E1913]	[0] Disable [1] kW [2] Min No. [3] kW & Min No.	Inhibits heavy consumer control, or select criteria used to authorize the use of a heavy consumer.
Avail kW req 1 [E1911]		Power that needs to be available in order to supply heavy consumer n°1.
Min no. GE rq1 [E1912]		Minimal number of running engines in order to supply heavy consumer n°1.
Avail kW req 2 [E4121]		Power that needs to be available in order to supply heavy consumer n°2.
Min no. GE rq2 [E4122]		Minimal number of running engines in order to supply heavy consumer n°2.
Avail kW req 3 [E4123]		Power that needs to be available in order to supply heavy consumer n°3.
Min no. GE rq3 [E4124]		Minimal number of running engines in order to supply heavy consumer n°3.
Avail kW req 4 [E4125]		Power that needs to be available in order to supply heavy consumer n°4.
Min no. GE rq4 [E4126]		Minimal number of running engines in order to supply heavy consumer n°4.
Delay betw req [E4127]		Delay before processing a heavy consumer request after an authorization has just been issued for another request.
Power reserve [E4128]		Amount of kW that should always be kept available on running generating sets. If this power is not available, an additional engine will start.

TABLE 82 - HEAVY CONSUMER CONTROL MENU



This menu is only available in modules from the MARINE range.

This menu allows the setup of parameters used for the management of heavy consumers as described in chapter 14.13.

Parameter [var.num]	Possible value	Comment
Min Hz trip [E1905]	[0] Disable [1] Non-essential consumer trip	Enable tripping of non-essential consumers if the power plant frequency slows down.
Min Hz level 1 [E1903]		Frequency level below which non-essential consumers will be tripped.
Min Hz level 2 [E1904]		Frequency level below which non-essential consumers will be tripped. Should be set lower than level 1.
Max kW trip [E1908]	[0] Disable [1] Non-essential consumer trip	Enable tripping of non-essential consumers if the load of the power plant is too high.
Max kW level 1 [E1906]		Load level above which non-essential consumers will be tripped.
Max kW level 2 [E1907]		Load level above which non-essential consumers will be tripped. Should be set higher than level 1.
Level 1 delay [E1909]		Delay associated to level 1 thresholds before tripping non-essential loads.
Level 2 delay [E1910]		Delay associated to level 2 thresholds before tripping non-essential loads. Should be set shorter than delay 1.

TABLE 83 - NON ESSENTIAL CONSUMER TRIP MENU

19.3.3 GENERATOR

1/ Generator 1/2

Parameter [var.num]	comment
Nominal kW [E1006]	Nominal power of the generator.
Nominal kVAR [E1015]	Nominal reactive power of the generator.
Nominal Volt [E1107]	Voltage setpoint.
Nominal kW 2 [E1607] ⁽¹⁾	Second nominal power of the generator, activated with logical input or equations.
Nominal kVAR 2 [E1636] ⁽¹⁾	Second nominal reactive power of the generator, activated with logical input or equations.
Nominal Volt 2 [E1108] ⁽¹⁾	Second voltage setpoint, activated with logical input or equations.
PT ratio [E1007]	Ratio of the voltage transformers (Ex: 20 kV to 100 V: type in 200).
CT ratio [E1008]	Ratio of the current transformers (Ex: 100A to 5A: type in 20). Maximum ratio is 3250 (Representing e.g. 3250:1 or 16250:5).
cos(ϕ) setpoint [E1110] ⁽¹⁾	Power factor set point when running parallel to the mains. Note: this is an inductive power factor, meaning that reactive power will be positive (kVAR will be exported from the generating set into the Mains).

TABLE 84 - GENERATOR 1/2 CONFIGURATION

(1) Only available on level 2

2/ Generator 2/2

Parameter [var.num]	comment
kW low lim [E1091]	Lower power limit of the generating set; enter a value (in kW) that will prevent reverse power protection triggering.
kW high lim [E1092]	Upper power limit of the generating set; enter a value (in kW).
Base load kW [E1093]	Generator kW set point in constant production mode.
Base load kW 2 [E1094] ⁽¹⁾	Second generator kW set point in constant production mode, activated with logical input or equations.
Load ramp [E1151]	Time to ramp up from lower limit [E1091] to nominal kW [E1006].
Unload ramp [E1152]	Time to ramp down from nominal kW [E1006] to lower power limit [E1091].

TABLE 85 - GENERATOR 2/2 CONFIGURATION

(1) Only available on level 2

Generator electrical fault

This menu allows to set the parameters used when a generator electrical fault occur. (See §0 for more details)

Parameter [var.num]	comment
Re-synch delay [E1843]	Delay before the generator tries to re-synchronize with Mains after a "Generator electrical fault"
Attempts sync [E1844]	Number of attempts to re-synchronize

TABLE 86 - GENERATOR ELECTRICAL FAULT CONFIGURATION

Note:

In case of a generator electrical fault, the generator breaker is opened and the GENSYS 2.0 is in state 40. In this state the alternator is de-excited (if wired) during a delay [E1265]. After this delay, if the fault is still present there is a hard shut down; otherwise GENSYS 2.0 tries to re-synchronize.

AVR control

This menu allows setting the AVR control. (See §11.3 for more details)

Parameter [var.num]	comment
AVR gain [E1103]	AVR trip, to be set between 0 and 255.
AVR offset [E1104]	Output voltage to AVR, to be set between 0 and 255.
Volt droop [E1105]	Droop sent to AVR if reactive load sharing is undertaken with droop (if not using inter GENSYS 2.0 CAN bus or in manual mode).
U31 [E0003]	Display the phase-phase voltage U31
AVR output [E2040]	Display the sum of the AVR correction signals

TABLE 87 - AVR CONTROL CONFIGURATION

19.3.4 MAINS/BUS

Parameter [var.num]	Possible value	Comment
PeakShaving kW [E1096]		Mains power set point in peak shaving mode.
PeakShav. kW 2 [E1097] ⁽¹⁾		Second mains power set point in peak shaving mode, activated with logical input or equations.
kW measure [E1464]	CT [1]	Calculation of mains power from the single phase measurement of the GENSYS 2.0
	mA (G1-G3) [2]	Measure of mains power by external power transducer (G1 and G3 terminals)
CT ratio [E1930] ⁽²⁾		Ratio of the current transformers (Ex: 100A to 5A: type in 20). Maximum ratio is 3250 (soit 3250:1 ou 16250:5).
20mA setting [E1020] ⁽²⁾⁽³⁾		Power measured by an external transducer delivering 20 mA to the power input of GENSYS 2.0 (G1 and G3 terminals).
0kW setting [E1021] ⁽²⁾⁽³⁾		Current to the power input of GENSYS 2.0 (G1 and G3 terminals) delivered by an external transducer measuring 0 kW
PT ratio [E1016]		Ratio of your voltage transformer on the mains/bus side (Ex: 20 kV to 100V so enter 200).
NominalVoltage [E4008]		Nominal mains voltage (used for protection %)
Nominal Freq [E4009]		Nominal mains frequency (used for protection %)
Mains low lim. [E1606]		In No changeover mode, mains power setpoint to reach during load ramp before to open the mains breaker.
MainReturnCont [E1620] ⁽¹⁾	Disable [0]	After a mains fault, the unit automatically re-synchronize to mains after a mains back timer [E1085].
	Enable [1]	After a mains fault, the unit wait an extern command before to re-synchronize to mains.(see §14.2 for more details)

TABLE 88 - MAINS/BUS CONFIGURATION

- (1) Only available on level 2
- (2) Available according to the value of kW measure [E1464]
- (3) Ex: a 4-20mA transducer is used. 20ma corresponds to 500KW, it means E1020=500; E1021=4;

Mains electrical fault

Parameter [var.num]	Possible value	Comment
Open breaker [E1846]	Mains [1]	Select the breaker that will be opened upon a "Mains electrical fault"
	Generator [2]	
	Both [3]	
Start on fault [E1841]	Yes[0]	Allow the engine to start on a "Mains electrical fault".
	No [1]	Don't allow the engine to start on a "Mains electrical fault".

TABLE 89 - MAINS ELECTRICAL FAULT CONFIGURATION

19.3.5 ENGINE

Parameter [var.num]	Possible value	Comment
Start sequence [E1608]	Internal start sequence [0]	The start sequence is managed by the GENSYS 2.0 (See §8 for more details)
	External Auto start module [1]	The start sequence is managed by an external module (See §14.5 for more details)

TABLE 90 - EXTERNAL/INTERNAL START SEQUENCE CONFIGURATION

Crank settings

This menu is showed only if an internal start sequence has been selected. It allows setting the following parameters:

Parameter [var.num]	comment
Starts attempt [E1134]	Number of start attempts.
Num of starter [E1138] ⁽¹⁾	Number of starter.
Sta.1 drop out [E1325]	The speed (RPM) above which the engine is considered to be started for crank 1.
Sta.2 drop out [E1325] ⁽¹⁾	The speed (RPM) above which the engine is considered to be started for crank 2.
Sta.3 drop out [E1325] ⁽¹⁾	The speed (RPM) above which the engine is considered to be started for crank 3.

TABLE 91 - CRANK CONFIGURATION PARAMETERS

(1) Only available on level 2

Checking before starting

This menu is showed only if an internal start sequence has been selected.

Parameter [var.num]	comment
Water temp. [E1154]	Pre-heat is activated if J5 is closed and if temperature is under the preset threshold (E0030 < E1154)
Oil prelube [E1155]	Prelube will be activated when engine state is "pre-start" and if pressure is under the threshold (E0029 < E1155). If the threshold [E1155] is 0, then prelube is active while the engine state is "pre-start". In this case, an oil pressure sensor isn't required
Cooling thresh [E1178] ⁽¹⁾	Air fan is activated when temperature is over the preset threshold [E1178] and deactivated when water temperature is lower than 80% of the threshold. Air fan is not active when engine is stopped.

TABLE 92 - CHECKING BEFORE STARTING CONFIGURATION

(1) Only available on level 2

Speed control settings

Parameter [var.num]	Possible value	Comment
Speed measure [E1078]	Magnetic [0]	Recommended if a magnetic pickup can be wired to G7 and G8 terminals of the GENSYS 2.0
	Alternator [1]	Speed measurement from generator frequency.
No. of teeth [E1106] ⁽²⁾		Number of teeth on the fly wheel (necessary if "magnetic" has been chosen as speed measurement source)
Pole pair no. [E1109] ⁽²⁾		Number of pairs of poles on the generator (necessary if "alternator" has been chosen as speed measurement source).
Idle speed [E1079] ⁽³⁾		Engine idle speed of the internal speed controller; the engine will accelerate from crank disconnect value to idle speed; then the speed will increase, following a ramp from idle speed to nominal speed.
Nom speed 1 [E1080]		First speed set point (default)
Nom speed 2 [E1081] ⁽¹⁾		Second speed set point, activated with logical input or equations.
Speed droop [E1075]		Droop of the internal speed controller.

TABLE 93 - SPEED CONTROL SETTINGS CONFIGURATION

- (1) Only available on level 2
- (2) Available according to Speed measure [E1078]
- (3) Idle speed should be set to nominal speed 1 value [E1080] if the internal speed controller is not used

Speed governor control

Parameter [var.num]	Comment
ESG gain [E1076]	To be set between -100 % for +10V to -10V output to external speed controller, and 100 % for -10V to +10V output. This value must be set to have a GENSYS 2.0 control speed deviation of +/- 3Hz on the engine. (See §11.1.1 for more details)
ESG offset [E1077]	Voltage on output to external speed controller without correction: between -100 % for -10V and +100% for +10V.
Generator freq [E0020]	Display generator frequency in Hz.
Engine speed [E0033]	Display engine speed in rpm.
Speed sign sum [E2058]	Display the speed output value.

TABLE 94 - SPEED GOVERNOR CONTROL CONFIGURATION

Parameter [var.num]	Comment
Manufacturer [E4034]	Manufacturer selection to communicate on COM2 by J1939 (See §17.3.2 for more details).
ECU type [E4068]	ECU selection to communicate on COM2 by J1939 (See §17.3.2 for more details).
CT J1939 Fault [E4080] ⁽¹⁾	Control when a CAN bus fault occurred (See §13 for more details).

TABLE 95 - J1939/MDEC CONFIGURATION

(1) Only available on level 2

If an ECU has been selected, it's possible to configure the engine protections according to the information received by J1939.

Parameter [var.num]	Comment
CT speed + [E1857]	Protection associated to a high speed.
CT speed ++ [E1862]	Protection associated to a very high speed.
CT Cool Temp+ [E1859]	Protection associated to a high water temperature.
CT Cool Temp++ [E1861]	Protection associated to a very high water temperature.
CT Oil Press – [E1858]	Protection associated to a low oil pressure.
CT Oil Press – – [E1860]	Protection associated to a very low oil pressure.
CT Malfunction [E1863]	Protection associated to an emission-related trouble code active.
CT Protection [E1864]	Protection associated to a problem with an engine system that is most probably not electronic subsystem related. For instance, engine coolant temperature is exceeding its prescribed temperature range.
CT Orange [E1865]	Protection associated to a problem with the engine system where the engine need not be immediately stopped.
CT Red [E1866]	Protection associated to a severe enough condition that it warrants stopping the engine.

TABLE 96 - J1939 PROTECTION CONFIGURATION

19.3.6 PROTECTIONS

All protections (Generator, Mains and Engine/Battery) work with:

- A threshold: trigger level of protection
- A timer: time before trig the protection
- A control: action to do when the fault is present (See §13 for more details)

To configure these protections, you can access to the following submenu.

- Generator protections
- Mains protections
- Engine/battery protections

1/ Generator protections

	Protection type	Threshold	Timer	Control
	Over frequency	E1022	E1023	E1024
	Under frequency	E1025	E1026	E1027
	Over voltage	E1031	E1032	E1033
	Under voltage	E1028	E1029	E1030
	Over current	E1052	E1053	E1054
	Over neutral current	E1055	E1056	E1057
	Reverse kW	E1040	E1041	E1042
	Reverse kVAR	E1037	E1038	E1039
	maxi kW	E1049	E1050	E1051
	mini kW	E1046	E1047	E1048
	maxi kVAR	E1037	E1038	E1039
	mini kVAR	E1034	E1035	E1036
 Uneven load sharing	Uneven kW	E4109	E4110	E4111
	Uneven kVAR	E4112	E4113	E4114

TABLE 97 - GENERATOR PROTECTIONS CONFIGURATION

Note: uneven kVAR protection requires the use of CAN bus communication between modules. So it is not available when parallel lines are used for load sharing control.

2/ Mains protections

Protection type	Threshold	Timer	Control
Over frequency	E1061	E1062	E1063
Under frequency	E1058	E1059	E1060
Over voltage	E1067	E1068	E1069
Under voltage	E1064	E1065	E1066
Reverse kW	E1414	E1415	E1416
Reverse kVAR	E1417	E1418	E1419
maxi kW	E1423	E1424	E1425
mini kW	E1420	E1421	E1422

Protection type	Threshold	Timer	Control
maxi kVAR	E1411	E1412	E1413
mini kVAR	E1408	E1409	E1410
Vector jump	E1070	immediate	E1071
ROCOF (df/dt)	E1072	Immediate	E1073

TABLE 98 - MAINS PROTECTIONS CONFIGURATION

Note: The parameter [E1637] (TM dfdt/vect.) allows to set the time from which the vector jump and ROCOF protections are enabled.

3/ Engine/Battery protections

Protection type	Threshold	Timer	Control
Over speed	E1160	E1161	E1162
Under speed	E1163	E1164	E1165
High water temp	E1169	E1170	E1171
Low oil pressure	E1166	E1167	E1168
Spare analog 1	E1180	E1181	E1182
Spare analog 2	E1184	E1185	E1186
Battery over voltage	E1086	E1095	E1098
Battery under voltage	E1172	E1173	E1174

TABLE 99 - ENGINE/BATTERY PROTECTIONS CONFIGURATIONS

Note: The parameters [E1183] and [E1187] allow setting the protection direction of the spare analog inputs 1 & 2. If we considered a maximum threshold or a minimum threshold to not cross: 0 means a maximum threshold/ 1 means a minimum threshold.

19.3.7 INPUTS

1/ Digital inputs

They are split between the dedicated inputs (J1 to J3) and the configurable inputs (J4 to J5).

For more details on the digital inputs configuration, see chapter §12.1.

2/ Analog inputs

To configure the analog inputs, the **CRE Config** software must be used.

For more details on the digital inputs configuration, see chapter §12.3.

3/ Expansion inputs



To configure the expansion, inputs, the **CRE Config** software must be used.

For more details on the expansion inputs configuration, see chapter §17.3.1.

4/ Virtual inputs



Virtual digital inputs are designed to offer more features to the end user. They can be programmed via equations or can copy the status of external (CANopen linked) inputs. For virtual digital inputs 1 to 40: label, validity, direction, and function have to be defined.

Variable numbers: [E2283 to E2302 and E2565 to E2584]

To configure the virtual inputs, the **CRE Config** software must be used.

Label

The name you give to the virtual input. This will be displayed in the info, alarm, and fault screens if so programmed.

Validity

Virtual input validity variable numbers: [E1348 to E1357 / E1388 to E1397 / E1640 to E1659] can be set as:

- **Never** [E2329]: never active: should be selected if you do not use the input.
- **Always** [E2330]: always active: input will be monitored as long as GENSYS 2.0 has power supply.
- **Post-Starting** [E2192]: the input will be monitored at the end of the "safety on" timer.
- **Stabilized** [E2331]: The input will be monitored when generating set frequency and voltage are stable.
- **Spare scenario**: [E2332]: input will be monitored as programmed in equations.

Direction

Virtual input direction variable numbers: [E1358 to E1367 / E1398 to E1407 / E1659 to E1679]. Can be set as:

- **NO** [0]: normally open; should be selected unless the input is used for protection.
- **NC** [1]: normally closed. This should be selected if the input is normally connected to 0V and opens when active.

Accuracy

This parameter sets accuracy (number of digits after decimal point). Possible values are:

- 1
- 0.1
- 0.01
- 0.001

Functions

Virtual input function variable numbers: [E1328 to E1337 / E1368 to E1377 / E1680 to E1699] can be set as described in chapter §12.1.5.

Note: Both virtual and real inputs use the same functions.

19.3.8 OUTPUTS

1/ Digital outputs

This menu allows configuring the digital outputs (C1 to C5).

For each digital output, the settings are:

- Function :
The function associated to the digital output.
For more details on the available functions, see chapter §12.2.1.
- Polarity :
NE: normally energized; the output will de-energize when required, depending on its function.
ND: normally de-energized; the output will energize when required.

Output	Function	Polarity
C1	E1260	E1436
C2	E1261	E1437
C3	E1262	E1438
C4	E1263	E1439
C5	E1264	E1440

TABLE 100 - DIGITAL OUTPUTS CONFIGURATION

2/ Relay outputs

The "Crank" and "Fuel" relay (output A1 and A2 respectively) can be configured to other functions.

Parameter [var.num]	Comment
Crank relay [E1989]	Function of the A1 output.
Fuel relay [E1916]	Function of the A2 output.

TABLE 101 - RELAY OUTPUTS CONFIGURATION

Notes:

If E1916= "Unused" the default parameter are used, with [E2019] set on A1 output (Fuel).

If E1989= "Unused" the default parameter are used, with [E2018] set on A2 output (Crank).

The polarity can't be changed on these outputs.

3/ Breakers

This menu is used to set the breakers configuration (generator and mains). Each breaker can be configured with one of the 6 values below (see §11.4.1 for more details)

0 =	Open contact	Close pulse
1 =	Open contact	Close contact
2 =	Open MXcoil	Close pulse
3 =	Open MXcoil	Close contact
4 =	Open pulse	Close pulse
5 =	Open pulse	Close contact

TABLE 102 - BREAKERS CONFIGURATION

Mains brk ctrl [E1992]: Mains breaker control.

GE brk ctrl [E1993]: Generator breaker control.



To configure the expansion, outputs, the **CRE Config** software must be used.
For more details on the expansion outputs configuration, see chapter §17.3.1.

19.3.9 TIMERS

This menu allows setting up the timers:

- Engine
- Mains

1/ Engine

This page describes the settings for the engine start sequence. (See §8 for more details)

Parameter [var.num]	Comment
RemStart delay [E1990]	Remote start latency time
Prelub time [E1145] ⁽³⁾	Time to energize a prelube output for a lubrication pump before cranking.
Preglow time [E1157] ⁽³⁾	Time to energize a preglow output for preheat plugs before cranking.
Crank time [E1135] ⁽³⁾	Maximum time for which the crank relay is energized during a start attempt.
Fail to start [E1633] ⁽²⁾	Time to wait before trigger a fail to start fault.
Def. GE ready [E1146] ⁽²⁾	The longest acceptable delay for engine start.
Crank Rest Time [E1136] ⁽³⁾	Time to wait between two cranking attempts.
Warm up time [E1139] ⁽³⁾	Time to wait before taking the load to allow the engine to warm up.
Speed stabil. [E1140]	When generating set is started, time to wait before triggering an alarm because of an unstable speed.
Volt stabil. [E1141]	When generating set is started, time to wait before triggering an alarm because of an unstable voltage.
Safety ON time [E1514] ⁽³⁾	Delay before enable protections (e.g. oil pressure, under-speed...) when starting the engine.
TM sensor lost [E1458] ⁽¹⁾	Time after a "sensor lost" security fault will be trigger if no signal is read from speed measurement input.
Cooling time [E1142]	Time the engine will run without load before stopping.
Eng. Stop time [E1143] ⁽³⁾	Delay after which the engine is considered to be not stopped.
Rest time [E1144] ⁽³⁾	The minimum time the engine will wait before re-starting after being put at rest.

TABLE 103 - ENGINE TIMERS CONFIGURATION

- (1) Only available on level 2
 (2) Available if an external start module has been selected
 (3) Not available if an external start module has been selected

2/ Mains

Parameter [var.num]	Comment
Mains back [E1085]	In Change Over mode, time GENSYS 2.0 will wait to ensure a stable mains return.
ChangeOver N/E [E1459]	Change over time transfer.

TABLE 104 - MAINS TIMERS CONFIGURATION

19.3.10 SYNCHRONIZATION

1/ Synchronization check relay

This menu allows setting the synchronization parameters used to allow the synch check relay to operate.

Parameter [var.num]	Comment
Voltage match [E1127]	The maximum difference (in percent) between generating set and busbar voltage that allows the synch check relay to operate.
Freq. match [E1128]	The maximum frequency difference between generating set and busbar that allows the synch check relay to operate.
Phase match [E1129]	The maximum phase angle difference allowed between generating set and busbar for the sync check relay to operate.
Min volt [E1432]	The minimal percentage of nominal voltage on both sides of the breaker to allow sync check relay to operate.
Max volt [E1433]	The maximal percentage of nominal voltage allowed on both sides of the breaker for the sync check relay to operate.
Min frequency [E1434]	The minimal percentage of nominal frequency allowed on both sides of the breaker for the sync check relay to operate.
Max frequency [E1435]	The maximal percentage of nominal frequency allowed on both sides of the breaker for the sync check relay to operate.
Fail to synch. [E1150]	This timer will trigger a fail to synchronize protection if generating set has not synchronized within the time you enter.
C2S dwell time ⁽¹⁾ [E4108]	Synchronization dwell time before authorizing to close the breaker.
Phase offset ⁽²⁾ [E1929]	Phase offset between the mains and generator voltage.
CT Fail synch [E1928]	This selects the course of action in case of impossible synchronization. (See §13 for more details)

TABLE 105 - SYNCHRO CHECK RELAY CONFIGURATION

- (1) This parameter can be modified using TXT file or modification by variable number menu.
- (2) Available if option 8 is enabled.

2/ Frequency PID

This menu allows tuning the frequency and phase synchronization PID in order to decrease the synchronization time. (See §14.12 for more details on PID)

Parameter [var.num]	Comment
Frequency	
G [E1111]	Global gain of the frequency synchro
I [E1113]	Integral of the frequency synchro
Phase - Angle	
G [E1307]	Global gain of the phase synchro
I [E1309]	Integral of the phase synchro

TABLE 106 - PHASE SYNCHRO PID CONFIGURATION

The internal GENSYS 2.0 synchroscope is displayed and lets you monitor in real time the changes you make on these parameters.

19.3.11 CONTROL LOOP

1/ kW control

kW sharing loop

This menu allows setting the kW sharing PID when the generator shares the load with other generators. (See §14.12 for more details on PID)

Parameter [var.num]	Comment
G [E1102]	Global gain of kW sharing

TABLE 107 - KW SHARING LOOP PID CONFIGURATION

While you adjust the PID settings, the following parameters are displayed:

- Generator active and reactive power (P et Q),
- Engine speed,
- Generator voltage (phase 1),
- Frequency,
- Sum of the speed output (en %).

Ramp/Constant kW

This menu allows setting the power management PID when one generator is paralleled with mains. (See §14.12 for more details on PID)

Parameter [var.num]	Comment
G [E1099]	Global gain of ramp/constant kW
I [E1101]	Integral of ramp/constant kW

TABLE 108 - RAMP/CONSTANT KW PID CONFIGURATION

While you adjust the PID settings, the following parameters are displayed:

- Generator active and reactive power (P et Q),
- Engine speed,
- Generator voltage (phase 1),
- Frequency,
- Sum of the speed output (en %).

Hz loop

This menu is only available in level2. It allows to set the center frequency PID (See §14.1 for more details)

Parameter [var.num]	Comment
G [E1902]	Global gain of the center frequency

TABLE 109 - PID HZ LOOP CONFIGURATION

While you adjust the PID settings, the following parameters are displayed:

- Generator active and reactive power (P et Q),
- Engine speed,
- Generator voltage (phase 1),
- Frequency,
- Sum of the speed output (en %).

2/ kVAR control

kVAR sharing loop

When reactive load sharing is enabled, this menu allows setting the kVAR sharing PID. (See §14.12 for more details on PID)

Parameter [var.num]	Comment
G [E1123]	Global gain of the reactive load sharing

TABLE 110 - PID KVAR SHARING LOOP

While you adjust the PID settings, the following parameters are displayed:

- Generator active and reactive power (P et Q),
- Engine speed,
- Generator voltage (phase 1),
- Reactive power set point,
- 3 phases reactive load.

cos(φ) loop

This menu allows to set the cos(φ) control when the generator is paralleled with mains. (See §14.12 for more details on PID)

Parameter [var.num]	Comment
G [E1119]	Global gain of cos(φ) control
I [E1121]	Integral of cos(φ) control

TABLE 111 - PID COS(φ) LOOP CONFIGURATION

While you adjust the PID settings, the following parameters are displayed:

- Generator active and reactive power (P et Q),
- Engine speed,
- $\cos(\varphi)$ setpoint,
- $\cos(\varphi)$ by phase (1, 2 and 3),
- $\cos(\varphi)$ global.

19.3.12 FIFO DATA LOGGER

Log on/off: [E1988] set to "ON" to enable the data logger.

Log Var 1 à Log Var 10: Set here the variable value you want to watch. When set to "-1" the Log Var is disabled.

Data are recorded when the variable's value changes. Each data is recorded in the following form:

jj/mm/aa hh:mn:ss label XXXX=YYYY . XXXX is the variable number and YYYY the value of the variable.

The recording can be downloaded from the web site.

Note: The unit can save up to 2000 data. This includes archived alarms and faults.

19.3.13 MAINTENANCE CYCLE

This menu allows resetting the maintenance cycle.

Only the configured maintenance cycle will be displayed.

Parameter [var.num]	Comment
ResetMeter1(h) [E4097]	Reset maintenance cycle 1 in hour
ResetMeter2(h) [E4098]	Reset maintenance cycle 2 in hour
ResetMeter3(h) [E4099]	Reset maintenance cycle 3 in hour
ResetMeter4(h) [E4100]	Reset maintenance cycle 4 in hour
ResetMeter5(h) [E4101]	Reset maintenance cycle 5 in hour
ResetMeter1(d) [E4102]	Reset maintenance cycle 1 in day
ResetMeter2(d) [E4103]	Reset maintenance cycle 2 in day
ResetMeter3(d) [E4104]	Reset maintenance cycle 3 in day
ResetMeter4(d) [E4105]	Reset maintenance cycle 4 in day
ResetMeter5(d) [E4106]	Reset maintenance cycle 5 in day

TABLE 112 - RESET OF MAINTENANCE CYCLE

19.3.14 MODIFICATION BY VARIABLE NO

This menu item is very useful when you are familiar with key variable numbers, for example the ones you modify often. Simply enter the variable number, and then enter its value.

Note: You can only change parameters (settings) E1xxx and E4xxxx. Some of these settings are not accessible from other menus.

With the level 2 password, you can configure the writing ability via Modbus or PLC (equations). This is also visible and settable in the third column of the parameters file. Y (Yes) = allowed / N (No) = not allowed. (See §16.3.2 for more details)

Modification by variable nb

Gen nominal kW:1006= kW

Writing by MODBUS/PLC :
 ▼

FIGURE 88 - MODIFICATION BY VARIABLE NUMBER

19.4 SYSTEM MENU

This will give access to the following menus which display system parameters; some of them can be modified.

- Date/Time/Meters
- Passwords/Options
- Screen saver
- Languages
- Communication ports config.
- GENSYS 2.0 -> PC file(only on web site)
- PC -> GENSYS 2.0 file (only on web site)
- Download logo (only on web site)
- Update firmware (only on web site with level 2 password)
- Reset factory settings (only in level 2)
- About

19.4.1 DATE / TIME / METERS

1/ Date / Time

This menu allows modifying the date and the time.

Parameter [var.num]	Comment
Date format [E1516]	Select the date format « day/month/year» or « month/day/year »
Date [E0067]/[E0068]/[E0069]	Adjust the date
Time(hh:mm) [E0070]:[E0071]	Adjust the time

TABLE 113 - DATE AND TIME SETTINGS

2/ Meters reset

This menu allows resetting the following meters.

[var.num]	Comment
[E0025]	kW generator sum
[E0125]	kVAR generator sum
[E0061]	kW mains sum
[E0063]	kVAR mains sum
[E0065]	Running hours
[E0027]	Number of start
[E1988]	Event logger

TABLE 114 - METERS RESET

3/ Meters preset

This menu, only available in level 2, allows presetting the following meters.

[var.num]	Comment
[E0025]	kW generator sum
[E0125]	kVAR generator sum
[E0061]	kW mains sum
[E0063]	kVAR mains sum
[E0065]	Running hours
[E0066]	Running minutes
[E0027]	Number of start
[E2657]	User meter n°1
[E2659]	User meter n°2

TABLE 115 - METERS PRESET

For the two dedicated meters [E2657] and [E2659] you can modify:

- The meter name
- The meter unit
- The meter accuracy.

“User meters” are 4 user variables (E2657 to E2660) stored in a non-volatile memory. Their value is stored even in case of a loss of power supply. These data can be set through custom equations or Modbus access for example.

Displaying variable E2657 (or E2659) on an information page for example will in fact display the combination of variables [E2657] and [E2658] (or E2659 and E2660) as if it was a single 32 bits variables, allowing to display values higher than 32767.

Note: It is only true for display. No real 32 bits computation is done internally. For example, continuously incrementing variable [E2657] will never end up in incrementing variable [E2658] (and the same applies to variables [E2659] and [E2660]).

19.4.2 PASSWORD / OPTIONS

1/ Password

This screen allows you to change passwords, from level 0 to the currently connected level. Passwords are limited to 8 characters maximum.

2/ Options

This part shows options that are enabled inside your module. For more information on options, or to lock/unlock one of them, please contact your local CRE Technology distributor.

OFF is an inactive option, ON is an active option.

2: Mains paralleling option. For single generator paralleled with the mains (Phase shift + ROCOF + power management + display).

5: Disable paralleling function (AMF).

6: MASTER 2.0. This is a "factory only" configurable option. This option is set to OFF on GENSYS 2.0, and set to ON in the MASTER 2.0.

7: Disable the internal start sequence

8: Phase offset option. This option is generally used with HIGH VOLTAGE transformer applications.

19.4.3 SCREEN SAVER

1/ Introduction

The screen displayed when user does not interact with GENSYS 2.0 (keys not used) is called "SCREEN SAVER". Information displayed on this screen is automatically chosen depending on GENSYS 2.0 status, as described in table below. Some parameters can also be used to customize this behaviour.

Screensaver	Description	Displayed in AUTO mode	Displayed in MANUAL mode
Synchronization column	Frequency difference (bar graph) Voltage difference (bar graph) Phase difference (column) Frequency match (OK/NOK) Voltage match (OK/NOK) Phase match (OK/NOK)	In synchronization state	When the generator is ready and the generator breaker is open
Generator overview	KW (in large font) Voltage (in large font) Running hours (in large font)	When the generator breaker is closed	When the generator breaker is closed
Engine overview	Crank relay output Fuel relay output Water temp digital output Oil pressure digital output Emergency stop Remote start No. of start attempts Battery voltage (bar graph) Engine speed (bar graph)	In start and fault state	When you press start, or when in fault state
Customized screen	4 custom lines Customer logo Current date and time	In wait state (engine stopped)	In other cases

TABLE 116 - SCREEN SAVER MODE

2/ Menu

Parameter [var.num]	Comment
TM scr.saver [E1266]	Time (in minutes) after which the front panel display will exit menus and show the screen saver.
TM backlight [E1014]	Time (in minutes) after which the front panel display backlight will be switched off. The light will be switched on again as soon as a key is pressed on the front panel.
LCD backlight [E4095]	Adjust the LCD backlight from 0 to 100% of the maximum backlight intensity.
Line 1 to Line 4	The 4 lines of text displayed in the "Customized screen" can be modified as well. Each line can be up to 28 characters in length.

TABLE 117 - SCREEN SAVER

Note: If you change this text from your computer, make sure your "PC language" is the same as the "local language", as the text displayed is local language related.

19.4.4 LANGUAGES

Parameter [var.num]	Possible value	Comment
PC language [E1311]	English [0]	Allows you to choose the language of the menus displayed on your computer.
	Francais[1]	
	Espanol [2]	
	Custom [3]	
Local language [E1156]	English [0]	Allows you to choose the language of the menus displayed on your GENSYS 2.0 front panel.
	Francais[1]	
	Espanol [2]	
	Custom [3]	

TABLE 118 - LANGUAGE SELECTION

Note: By default, the Custom language is the Italian language. It's possible to download a language file in order to modify the Custom language (See §16.7 for more details)

19.4.5 COMMUNICATION PORTS CONFIG

1/ COM1 (CAN1 INTERGENSYS)

This isolated communication port is dedicated to inter-unit data communication using a proprietary protocol. This bus allows synchronization, load sharing (active and reactive), dead bus management, automatic load/unload, Broadcast data...

Action to be performed upon CAN bus fault [E1259] occurrence can be set using password level 2. (See §17.2.1 for more details)

2/ COM2 (CANopen-J1939)

This bus is used for communication with CANopen remote I/O modules (Beckhoff, Wago...) or electronic engines communication (J1939 or MTU MDEC).

3/ COM3 (USB: TCP/IP PROTOCOL)

Reserved to CRE Technology.

4/ COM4 (ETHERNET)

This menu allows configuring the Ethernet connection to communicate with a PC. Please contact your network administrator to configure router and module(s) according to your need.

Parameter [var.num]	Possible value	Comment
Use DHCP [E4065]	Disable [0]	Enable the DHCP protocol (dynamic IP address) or disable (fix IP address)
	Enable [1]	
IP Address [E4010] à [E4013] ⁽¹⁾		Configure fix IP address of the unit (DHCP disable or in fault)
IP GW address [E4026] à [E4029] ⁽¹⁾		Configure gateway IP address (DHCP disable)
TCP [E4081]		TCP communication port

Parameter [var.num]	Possible value	Comment
UDP [E4082]		UDP communication port
Modbus TCP [E4083]		Modbus TCP communication port

TABLE 119 - ETHERNET CONFIGURATION

(1) Only available if DHCP protocol is disabled.

Note: modifications on these parameters are taken into account during power on sequence. So it is necessary to restart your module in order to use the new configuration.

5/ COM5 (RS485: MODBUS RTU)

This menu allows setting up Modbus RTU. (See §17.6 for more details)

Parameter [var.num]	Comment
Modbus address [E1634]	Define the GENSYS 2.0 Modbus SLAVE (RTU) address.
Modbus speed [E1441]	The following speeds are available: 4800, 9600, 19200bps.
Modbus rights ⁽¹⁾⁽²⁾ [E4107]	Allows defining the Modbus access rights access to the parameters. LCD menu gives access to the following predefined settings: Factory/Full access/Standard TCP – No RTU/Standard RTU – No TCP/No access. Web site menu gives access to fully customizable settings as described below.

TABLE 120 - MODBUS CONFIGURATION

(1) Only available with password level 2.

(2) On the computer, you will have access to check boxes in order to create your own configuration.

Starting from firmware v4.03, advanced access rights are available:



- Activate/Inhibit Read/Write access individually on Modbus RTU or Modbus TCP communication ports.
- Write access to date/time/counters.
- Global write access to all configuration parameters.

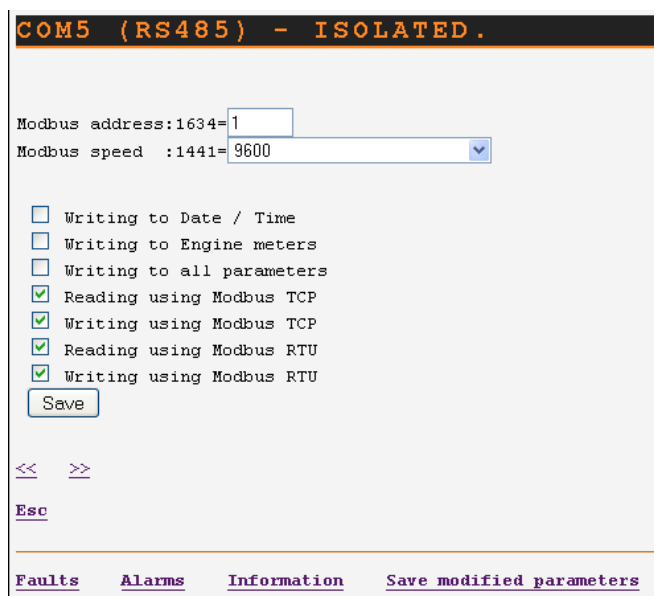

FIGURE 89 - MODBUS RIGHTS ACCESS SCREEN

Starting from firmware v4.03, “Writing to all parameters” enables access right to all configuration parameters independently from individual “Modbus/PLC access right” that can be set on each parameter using “Modification by variable number” menu or TXT file with password level 2. When “writing to all parameters” is set, individual access right is not taken into account; when “writing to all parameters” is inactive, then individual access right can be used to enable write access to one or more specific parameters.

6/ COM6 (SD CARD)

Terminal for FLASH memory cards (SD card format).

This menu allows to set the recording time in seconds of the SD card logger (seer §17.7.1 for more details) and download/upload text file.

Parameter [var.num]	Comment
SD log. timer [E4041]	Recording time in seconds.

TABLE 121 - SD CARD CONFIGURATION

Module -> SD

This menu allows downloading a text file from module to SD card. (See §17.7.3 for more details)

SD -> Module

This menu allows uploading a text file from SD card to module. (See §17.7.3 for more details)

19.4.6 GENSYS 2.0 -> PC FILE

This menu is only available on web site. It allows downloading text file from module to PC:

- Download Gensys_File.txt
- Data logging
- Alarms/Faults summary



WARNING:

File transfer is only possible when engine is stopped.

1/ Download Gensys_File.txt

By selecting “Download Gensys_file.txt”, the current configuration file will be displayed in your internet browser.

Use the “File / Save as...” menu of your browser to save this file.



WARNING:

If you use the text file to edit a new configuration, it is strongly recommended that you use the text file uploaded from the module, modify it, and download this new text file to the module. Always use a text file compatible with the installed firmware version.

2/ Data logging

By selecting « Data logging», a file containing all alarms/faults as well as the parameters define in the FIFO data logger is displayed in your browser. (See §19.3.12 for more details on FIFO data logger)

Use the “File / Save as...” menu of your browser to save this file.

3/ Alarms/Faults summary

By selecting « Alarms/Faults summary», a file containing all potential alarms/faults and their use. (See §13.10 for more details)

Use the “File / Save as...” menu of your browser to save this file.

Example:

```
***** Alarms/Faults summary *****
```

```
0 : Disable
1 : Generator electrical fault
2 : Mains electrical fault
3 : Alarm
4 : Fault (Soft shut down)
5 : Security (Hard shut down)
6 : Speed droop
7 : Help + Fault(Soft shut down)
8 : Help + Gen. Electrical fault
```

Potential alarm/fault	Actually setup as	ANSI C37-2
V0130 CAN bus fault	<-- V1259 = 6	
V2347 Oil pres fault	<-- V0922 = 5	
V2004 Water Temp	<-- V0922 = 5	
V2005 Emergency stop	<-- V0922 = 5	
V2097 Generator +f	<-- V1024 = 0	81H
V2101 Generator -f	<-- V1027 = 0	81L
V2105 Generator -U	<-- V1030 = 0	27
V2109 Generator +U	<-- V1033 = 0	59
V2113 Min kVAR	<-- V1036 = 0	37Q
V2117 Max kVAR	<-- V1039 = 0	32Q
V2121 -kW	<-- V1042 = 5	32RP
V2125 -kVAR	<-- V1045 = 0	32RQ
V2129 Min kW	<-- V1048 = 0	37P
V2133 Max kW	<-- V1051 = 0	32P
V2137 Max I	<-- V1054 = 0	51
V2141 Max In	<-- V1057 = 0	50N
V2145 Mains -f	<-- V1060 = 0	81L
V2149 Mains +f	<-- V1063 = 0	81H
V2153 Mains -U	<-- V1066 = 0	27
V2157 Mains +U	<-- V1069 = 0	59

.....

19.4.7 PC -> GENSYS 2.0 FILE

This menu is only displayed on the computer. It allows sending parameters file, equations file or language file.

Use the “Browse...” button to choose the file to download and click on “save” button.

When the operation is completed, a screen will appear showing:

Compilation result

Compilation successful.
Available space : 63766 / 49%

Esc

Faults

Alarms

Information

Save modified parameters

FIGURE 90 - COMPILATION RESULT SCREEN

Notes:

We recommend you first save the current configuration using the “GENSYS 2.0-> PC” menu before making changes.

File transfer is only possible when engine is stopped.

19.4.8 DOWNLOAD LOGO

This menu is only displayed on the computer.

This menu allows you to change the screen saver logo on the module front panel. Use the “Browse...” button to choose the logo to download and click on “save” button. When the operation is completed, a screen will appear showing:

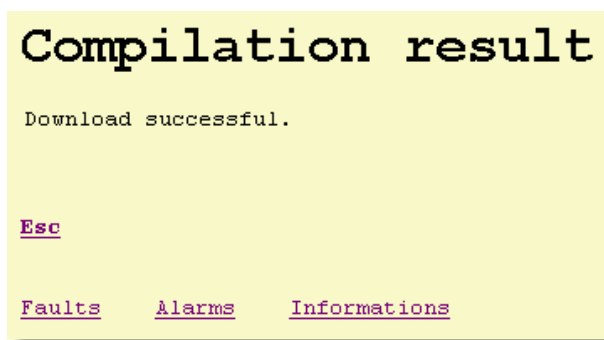

FIGURE 91 - DOWNLOAD LOGO SCREEN

Notes:

The picture must be a monochromatic BMP file of 72*54 pixels.

File transfer is only possible when engine is stopped.

19.4.9 UPDATE FIRMWARE

This menu is only available in level 2 and on computer.

It allows updating the software with the latest version. (See §17.7.2 for more details)

19.4.10 RESET FACTORY SETTING

This menu is only available in level 2.

It resets the factory settings of the module: parameters, labels, equations... (See §16.6 for more details)

19.4.11 ABOUT

This menu displays some information on module and on Ethernet connection.

- Serial number
- Software version
- Boot software version
- Module name
- IP address
- Gateway IP address
- MAC address
- DHCP status
- Copyright for lwip (See §17.5.2)

19.5 DEDICATED SCREENS

The dedicated screens are:

- The faults page
- The alarms page
- The information page.

19.5.1 FAULTS

At any time and any level, you can click on the "**Faults**" link on your browser or press the **[FAULT]** key on the front panel. Click **BACK** on your internet browser or press the button a second time to return to your previous screen. The last 50 faults will be display as follows:

dd/mm/yy hh:mn:ss protec. label XXXX=On (or Off). XXXX is the variable number.

By pressing "<<" or ">>", you can change between the active faults, 1st to 10th faults, 11th to 20th faults...

Faults 1/5

20/03/08	11:07:38	Input 4	2009=Off
20/03/08	11:07:38	Input 4	2009=On
20/03/08	11:07:38	Water temp	2004=Off
20/03/08	11:07:37	Water temp	2004=On
20/03/08	11:07:37	Water temp	2004=Off
20/03/08	11:07:37	Water temp	2004=On
20/03/08	11:07:27	Water temp	2004=Off
20/03/08	11:07:27	Water temp	2004=On
20/03/08	11:07:26	Input 4	2009=Off
20/03/08	11:07:26	Input 4	2009=On

<< >> Refresh Reset

FIGURE 92 - FAULTS SCREEN

Pressing "**Refresh**" will update the screen with last occurred faults(s). Pressing "**Reset**", in the "**Active faults**" page will reset the protection(s) which were triggered.

Note: The condition triggering the protection must first be corrected before resetting the alarm; failing to do this will trigger the protection again.

The Faults archive can be deleted in the "System/ Date-Time/meter/Meters reset" menu by selecting the Event logger parameter [E1988].

19.5.2 ALARMS

At any time and any level, you can click on the "**Alarms**" link on your browser or press the [**ALARM**] key on the front panel. Click BACK on your internet browser or press the button a second time to return to your previous screen. The last 50 alarms will be displayed as follows:

dd/mm/yy hh:mn:ss protec. label XXXX=On (or Off). XXXX is the variable number.

By pressing "<<" or ">>", you can change between the active alarms, 1st to 10th alarms, 11th to 20th alarms...

Pressing "**Refresh**" will update the screen with last occurred alarms(s). Pressing "**Reset**", in the "**Active alarms**" page, will reset the protection(s) which were triggered.

Note: The condition triggering the protection must first be corrected before resetting the alarm; failing to do this will trigger the protection again.

The alarms archive can be deleted in the "System/ Date-Time/meter/Meters reset" menu by selecting the Event logger parameter [E1988].

19.5.3 INFORMATION

At any time and any level, you can click the "Information" link on your browser or press the [i] key on the front panel. Choose BACK on your internet browser or press the button a second time to return to your previous screen.

This will automatically change the display and show the information screen.

The screenshot shows a terminal-style interface titled "Information 1/5". It displays two main sections: "Power" and "Engine". Each section has a status indicator (": Serious fault" and ": Fault" respectively) and a colon. Below these are several rows of parameter names, values in input boxes, and units. A "Save" button is at the bottom, followed by navigation arrows "<<" and ">>".

Parameter	Value	Unit
Generator kW	18	kW
Valid mains kW	60	kW
Gen. cos(phi)	21	0.00I
Mains cos(phi)	58	1.00I
Test mode	2096	1
kW GE09	50	0.0%
kW GE01	42	0.0%
kW GE02	43	0.0%
500 Hz ACT	1639	1
Generator f(%)	151	0.0%

FIGURE 93 - INFORMATION SCREEN

Power [E2071]: This will display the current status of the module regarding power management. It will also display a state code which is dedicated to the technical support team of your local distributor.

Engine [E2057]: This will display the current status of the module regarding the engine. It will also display a state code which is dedicated to the technical support team of your local distributor.

Parameter information: You can display any parameter by simply giving its variable number. By doing so, you can customize your information screen and display 10 parameters per page (5 pages available). Please refer to the technical documentation for list of variable numbers.

20 USEFUL INFORMATION

This page gives access to useful information concerning different areas of the GENSYS 2.0 unit's functioning.

20.1.1 SPEED REGULATION DETAILS

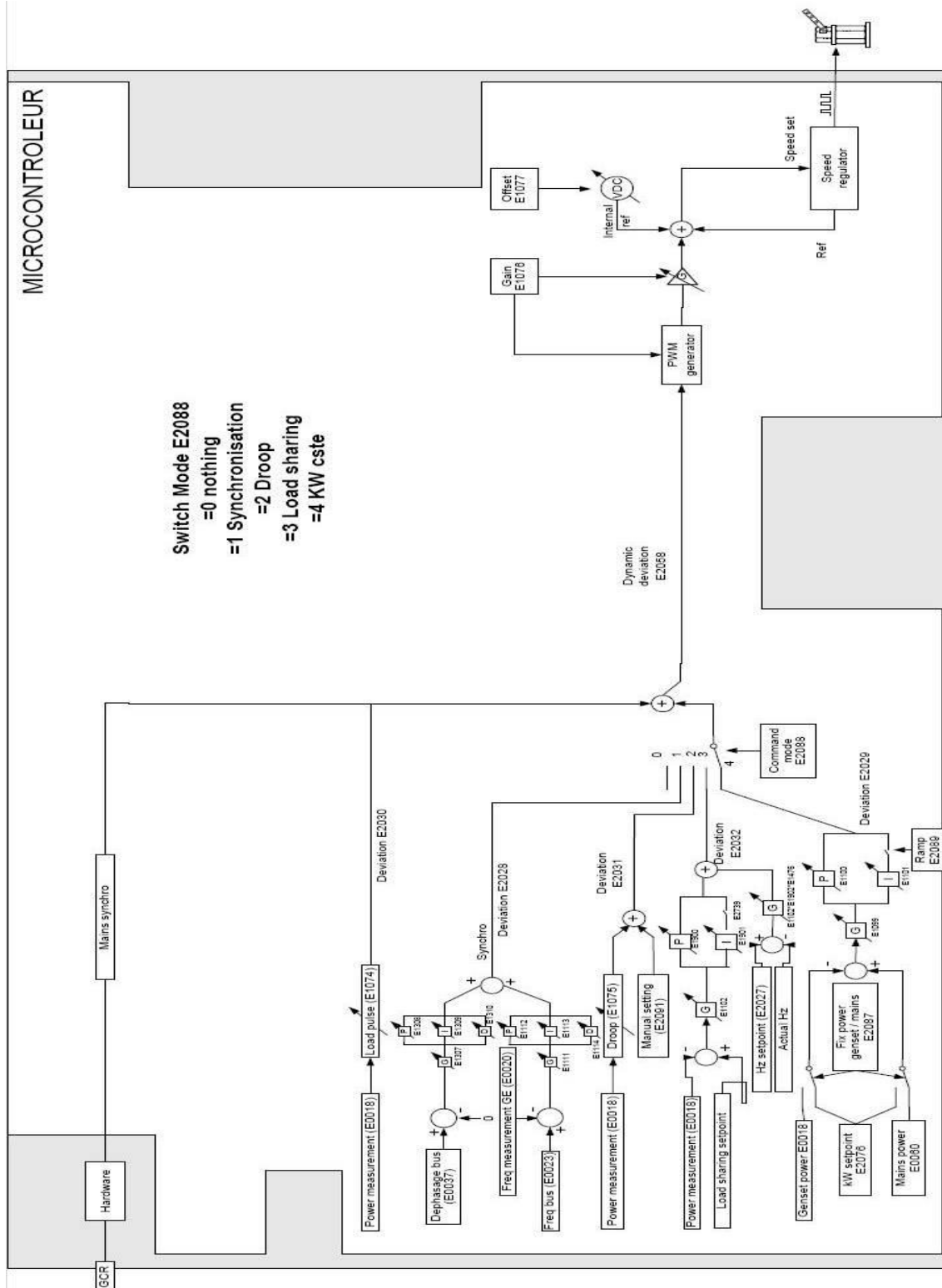

FIGURE 94 - SPEED REGULATION DETAILS

20.1.2 VOLTAGE REGULATION DETAILS

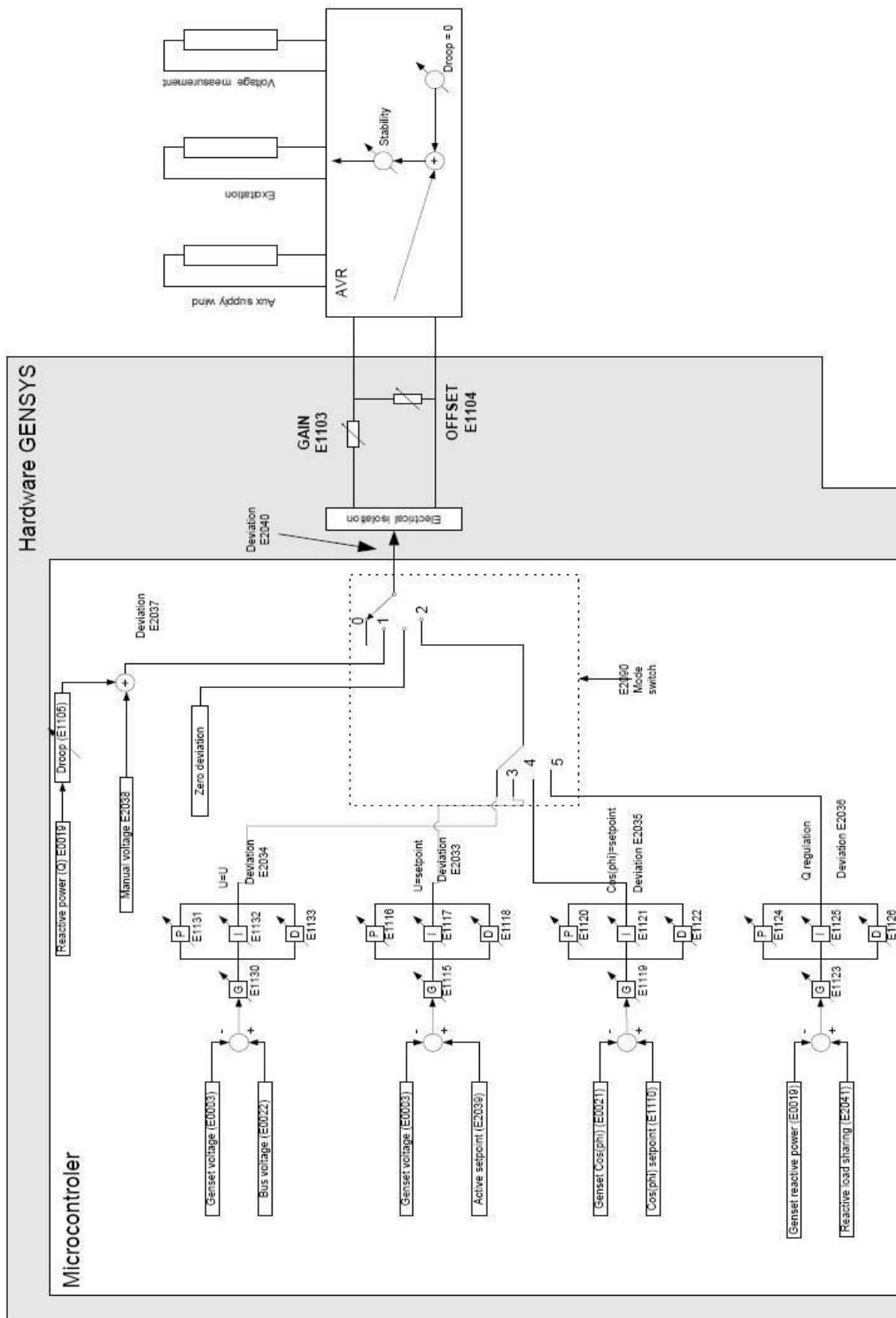

FIGURE 95 - VOLTAGE REGULATION DETAILS

21 PRECAUTIONS



Change over and paralleling with mains:

For safety reasons, breakers must be equipped with an independent paralleling safety relay to prevent failure of the automatic sequence, as shown in Figure 96 - Several generators warning and Figure 97 - One generator with mains warning.

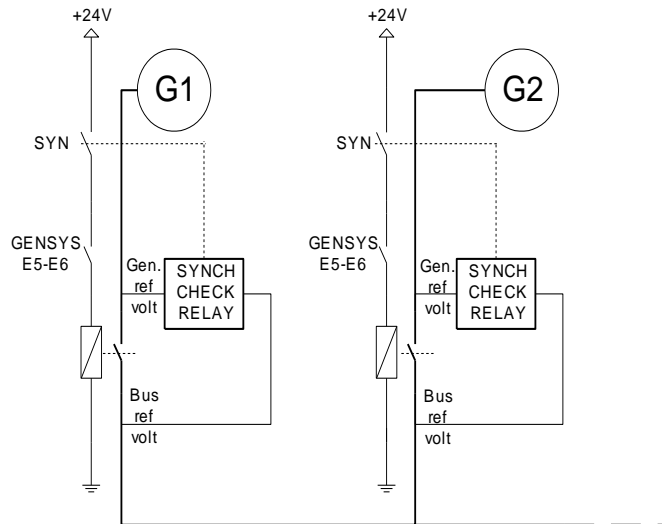
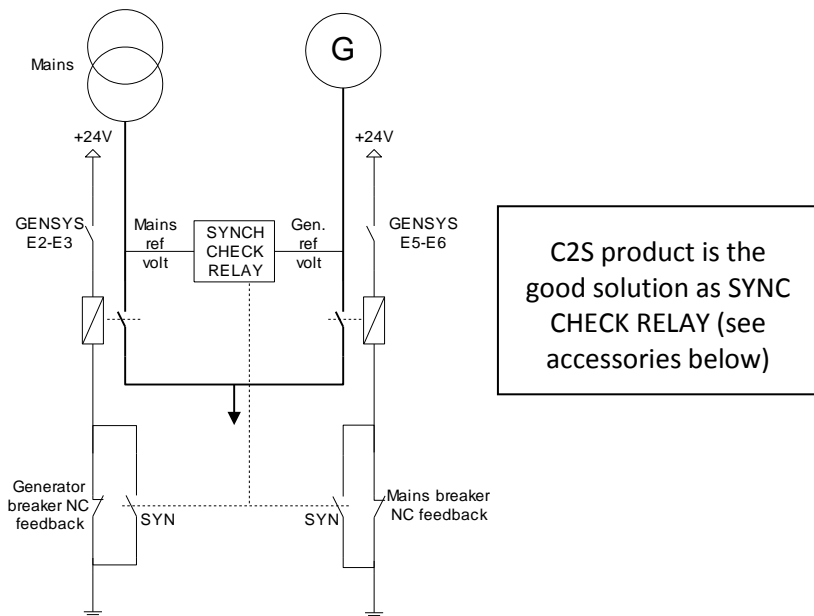

FIGURE 96 - SEVERAL GENERATORS WARNING



C2S product is the good solution as SYNC CHECK RELAY (see accessories below)

FIGURE 97 - ONE GENERATOR WITH MAINS WARNING



Manual breaker opening:

When an external security device opens the breaker, the order has to be latched. GENSYS 2.0 needs the feedback.

When a power plant has several generators, even if only one generator has a GENSYS 2.0, the number of generators (E1147) must be equal or above 2. If it is 1, you may seriously damage your generator.

The engine, turbine, or other type of prime mover should be equipped with an over speed (over temperature, or overpressure, where applicable) shutdown device that operates independently from the prime mover control device.

When a power plant has several generators, each GENSYS 2.0 must have a different number ("Genset number" variable: E1179). If two have the same number, there is no conflict but there will be some operating problems.

22 REFERENCES

22.1 PRODUCT REFERENCE

Reference	Description
A53Z0	GENSYS 2.0: all-in-one door-mounted genset control and paralleling unit with integrated PLC.
A53Z1	GENSYS 2.0 CORE: all-in-one back-panel mounted genset control and paralleling unit with integrated PLC.
A53Z2	GENSYS 2.0 LT: all-in-one genset control and paralleling unit.
A53Z3	GENSYS 2.0 MARINE: all-in-one door-mounted genset control and paralleling unit with integrated PLC and with marine functions.
A53Z4	GENSYS 2.0 CORE MARINE: all-in-one back-panel mounted genset control and paralleling unit with integrated PLC and with marine functions.
A53Z5	GENSYS 2.0 LT MARINE: all-in-one genset control and paralleling unit with marine functions.

TABLE 122 - GENSYS 2.0 PRODUCT REFERENCE

Full reference follows this format: A53Z0-L00xx (xx value depends on factory installed options).

Standard product is A53Z0-L0001.

Contact your local dealer for complete reference.

22.2 OPTIONS

Each of the following options can be selected and is password activated: contact your dealer for procedure.

OPT2: Mains paralleling option for single generator paralleled with the mains.

Some of the main paralleling functions are:

- Power management (command mode, peak shaving...)
- Phase shift
- ROCOF

OPT5: Disable paralleling function (AMF). Disabling this option will also disable option 2 “Mains paralleling” described above.

OPT8: Transformer phase shift compensation (HV, Dyn11 ...)

Note: on GENSYS 2.0 LT modules, option 2 is always linked to option 5. They are both factory enabled. Enabling/Removing option 5 will automatically enable/remove option 2.

A watchdog option is also available using logic output C5. This option must be specified when ordering your unit so that CRE Technology can produce it in the factory.

22.3 ACCESSORIES

CRE Technology provides a complete range of accessories to help you install and use your module. Some examples are given below. Please contact your local distributor to help you choose adequate equipment to fit your needs.

1/ Cables







Reference	Overview	Description
A53W1		Crossover RJ45 Ethernet cable (3m)
A40W2		DB9 female connector with 120Ω terminal resistor/free wires.
A40W3		DB9 connector accepting double cable connection. To be used on multiple generators applications
A40W4	 6 wires	CAN/RS485 communication cable without connectors. Length on request.
A40W5		DB9 120Ω termination dongle
A40W8		CAN cable for 2 GENSY 2.0 application (7m)

TABLE 123 - CABLE REFERENCE

2/ Other equipments

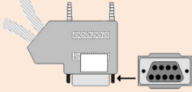
Table below shows some of many other types of equipment available in the CRE Technology product range.

Reference	Description
A53X0	Manual GENSY 2.0/MASTER 2.0 test bench.
A09Tx	GCR - digital Mains controller (ref A09T0 for 100V _{AC} , A09T1 for 230V _{AC} , and A09T2 for 400V _{AC}).
A24Zx	CPA – Converts three phase active power measurements into a +/-20mA signal. Exists for 100V _{AC} /5A, 230V _{AC} /5A, 400V _{AC} /5A, 100V _{AC} /1A, 230V _{AC} /1A and 400V _{AC} /1A measurements.
A61Y1	BSD Plus - remote management box (GPRS, email, SMS ...).
A25Z0	C2S - Auto Synchronizer and Safety Column to safely control the paralleling of two alternating power sources.

TABLE 124 - CRE TECHNOLOGY PRODUCT REFERENCE

23 CRE TECHNOLOGY



130, Allée Victor Naudin
Zone des Templier
Sophia-Antipolis
06410 Biot
FRANCE



Phone: +33 (0)4 92 38 86 82

Fax: +33 (0)4 92 38 86 83

Website: www.cretechnology.com



Email: info@cretechnology.com



Technical support: +33 (0)4 92 38 86 86 (office hours: 8.30AM-12AM / 2PM-6PM GMT+1).

Email: support@cretechnology.com



SKYPE: support-cretechnology.com



FIGURE 98 - ACCESS TO CRE TECHNOLOGY

Check our entire distributors list around the world on www.cretechnology.com tab "DISTRIBUTORS"



FIGURE 99 - CRE TECHNOLOGY DISTRIBUTORS

CRE Technology retains all copyrights in any text, graphic images, and software owned by CRE Technology and hereby authorizes you to electronically copy documents published herein solely for the purpose of transmitting or viewing the information.

© copyright
all rights reserved